



OPA 296RKTF-P (ECO) c/w UC8 Air Cooled Packaged Units - Reverse Cycle - R410A Installation & Maintenance

CONTENTS

	Page
1. General	1
2. Installation.....	2
3. Wiring.....	2
4. Start-Up Procedure.....	3
5. Operation.....	4
6. Controls.....	5
7. Maintenance.....	7
8. Troubleshooting.....	7
9. Warranty.....	8
Table 1: UC8 Display Information.....	8
Appendix I : Protection Features.....	9
Appendix II: Air Handling	10

1. GENERAL

Temperzone OPA Outdoor Air Cooled Packaged units.

Follow these instructions to ensure the optimum performance, reliability and durability.

Units must be installed in accordance with all national and regional regulations and bylaws. National Health and Safety regulations must be followed to avoid personal injuries.

The appropriate local permits must be acquired and adhered to.

Local regulations on maximum boundary noise need to be considered when positioning the unit.

GENERAL

2. INSTALLATION

Refer to diagrams below and in supplied Specifications sheet for minimum clearances. If multiple units are to be placed side-by-side then allow at least 2m between coil faces.

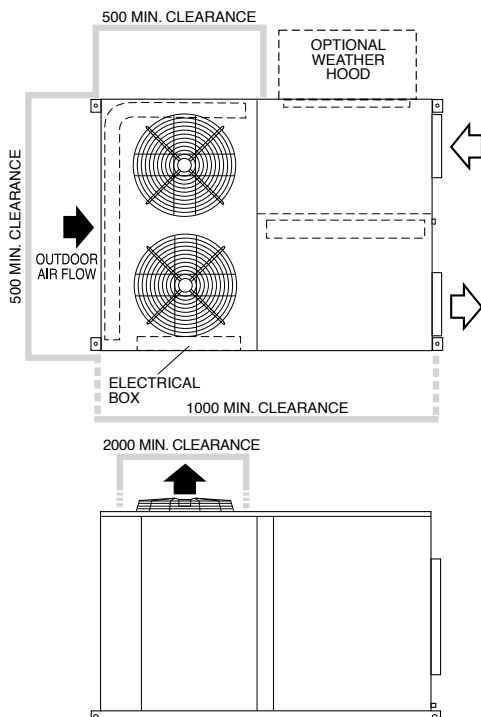

Figure 1.

2.1 Mounting

The unit should be fastened to a firm flat horizontal base using the holes supplied in the mounting channels. When the unit is being installed on a roof it is recommended that the unit is installed on a substantial structure with vibration isolating springs beneath the unit. These springs are not supplied with the unit.

Flexible duct connections are recommended between the supply and return ducts and the unit.

The unit is shipped with wooden blocks installed under the compressors. Ensure these blocks are removed from the compressor feet prior to starting the unit (not required for operation).

Factory filter slides are fitted, access to the filter access door should be considered when designing return and supply air ductwork. Access to the filters can still be achieved by removing the return air access door, however it is imperative that the rubber insulating washers be refitted to the screws prior to replacing the panel.

2.2 Condensate Drain

The condensate drain should be 'U' trapped outside the unit. The trap should have a vertical height of at least 100 mm. The drain should have a slope of at least 1 in 50 and must not be piped to a level above the unit drain pipe. (refer fig. 2)

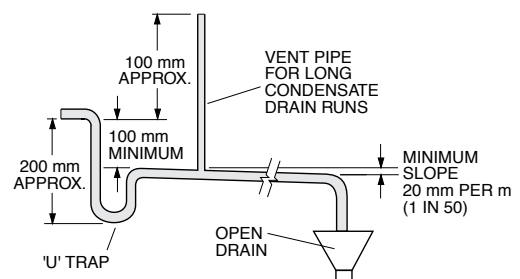

Figure 2.

INSTALLATION

3. REFRIGERATION SYSTEM

3.1 General

The OPA 296 model has a single inverter compressor to provide the flexibility and economy of variable speed operation. The compressor is very efficient at part load.

Each refrigeration system has been charged with HFC-410A (R410A) refrigerant; refer wiring diagram specification table for amount.

3.2 Compressors

The compressors is an inverter scroll type. The compressor lubricant is polyvinylether oil (PVE). Note, this oil absorbs moisture quickly if exposed to open air.

3.3 Economiser (Option) - ECO Plus Version

If the outdoor air temperature, or heat content preferably, is below that of the return air the fresh air damper can be opened and the return air damper closed to provide the first stage of cooling. The fresh air damper should return to minimum setting and the return air damper open before the compressors are allowed to operate to provide further cooling.

4. WIRING

4.1 Electrical Requirements

Electrical work must be done by a qualified electrician.

DANGER LIVE ELECTRICAL CONNECTIONS. REMOVE MAINS POWER BEFORE WORKING ON UNIT. ONLY QUALIFIED PERSONS WHO ARE COMPETENTLY TRAINED SHOULD PERFORM SERVICE AND MAINTENANCE TASKS.

The unit must be wired directly from a distribution board by means of a circuit breaker and a mains isolator provided - preferably close to the unit.

Note: DO NOT USE REWIRABLE FUSES.

The control transformer primary connection is 230-240V is used for countries with 230-240V power supply.

A 24 hour power supply to the compressor crank case heaters is required, otherwise the warranty is void.

4.2 Control options

The OPA unit can be controlled using any of the following options:

- TZT-100 wall thermostat
- SAT-3 wall thermostat
- 24V AC and 0-10V signals from an external controller or thermostat
- Remote on/off switch and/or time clock
- Modbus RTU serial communications over RS485 connection
- BACnet-IP serial communications over Ethernet connection (with optional gateway module)

The OPA unit is suitable for use with thermostats and controls with manual heating/cooling selection or automatic change-over.

A unit wiring diagram is supplied alongside the electrical board and in the Specifications document.

4.3 Remote on/off

The UC8 has an input for a remote on/off function on terminal 'On', signal return is terminal '0V'. When used the remote on/off terminals should connect to a voltage-free relay contact. When not used the remote on/off terminals should be shorted ('looped').

4.4 Capacity control

The OPA unit offers the following capacity control options:

- Automatic control when the unit connects to the TZT-100 or SAT-3 wall thermostat.
- 0-10V control signal via terminal 'VC' on the UC8 circuit board, signal return is terminal '0V'.
- Control by a building management system via Modbus RTU or BACnet-IP serial communications.

4.5 Unit Controller (UC8)



The temperzone Unit Controller 8 (UC8) is the successor to the UC6 controller. The UC8 controller receives requests such as 'Unit On/Off', 'Start compressors', 'Activate HEAT (Reverse Cycle)' and transfer the requests to the outputs after enforcing safety timers.

The Unit Controller provides several system protection functions. These are covered in Appendix I (p.9).

For additional information, refer to the UC8 Controller label on the unit or www.temperzone.biz for operation & fault diagnostics information; model search 'UC8'.

References available:

- UC8 Operation Manual : Air-to-Air Units
- UC8 Fault & Display Messages (as per unit label)
- UC8 Quick Reference and Operation Fault Diagnosis
- UC8 Troubleshooting Guide
- UC8 Modbus Communications
- UC8 BACnet Communications

5. START-UP PROCEDURE

5.1 Before starting the compressor

1. Before working on the unit remove mains power from the unit by opening the mains isolating switch.
2. Remove the shipping block from beneath the compressor. Check that the compressor is securely mounted.
3. Check the thermostat and/or other controls are correctly wired to the unit.
4. Check tightness of electrical connections.
5. Check the air filters have been correctly installed, if present.
6. Check that the indoor fan motor can freely rotate.
7. Apply mains power to the unit by closing the mains isolating switch.
8. Check the supply voltage between each phase and neutral.
9. Check air diffusers are open.
10. Before starting the compressor a four hour delay period is required to allow the crankcase heater to drive any liquid refrigerant out of the compressor oil. Mains power must be switched on during this four hour delay period.

5.2 Commissioning

After the four hour delay period has expired (see step 10 in section 5.1) complete the following procedure. You can use the Commissioning Sheet (supplied with the unit) to help you.

1. Place the UC8 Controller in commissioning mode holding down the push button on the circuit board (refer Section 4.5). Release the button when the display shows a small (lower case) letter 'c'. Safety time delays are now reduced and remain so for the next half hour, or until the controller is reset by removing power. 
2. Start the unit in cooling mode.
3. Check the outdoor fan motors run smoothly.

Note: Outdoor fans do not necessarily start rotating immediately after the compressor is started. The fans may run-on for a short period after the compressor stops.

Outdoor fans stop during outdoor coil de-ice cycles.
4. Measure the current draw on each phase to the compressor motor and to each fan motor. Check the readings against the specified values in the wiring diagram or specification sheet.
5. The display and pushbutton on the UC8 can be used to check temperatures and pressures. Short presses on the pushbutton cycles through the available options. **Table 1** on page 8 shows, in sequence, what information is available – with examples.

Alternatively use a set of pressure gauges suitable for R410A refrigerant.
6. Test operation of the unit when operating in heating mode.
7. Check for desired supply air flow rate at each outlet.
8. Touch up any outdoor unit paintwork damage to prevent corrosion.

5.3 Commissioning of variable speed (EC) indoor plug fan

The unit is equipped with a variable speed (EC) indoor plug fan which permits adjustment of the fan speeds to obtain the desired indoor supply airflows.







Using TZT-100 option

If the unit is controlled with a temperzone TZT-100 wall thermostat then adjustments are made as follows:

1. Stop the compressor. The UC8 display should show a flashing dot (•).
2. Hold down the pushbutton and release as soon as the display shows letter 'H'.
3. The indoor fan will start and run at high speed. The display shows the fan control voltage for the high speed setting, factory default value is 8V. 
4. Each following button press increases the control voltage in steps of 0.5V. The maximum is 10V. Pressing the button when the maximum of 10V is reached causes the control voltage to step down to the minimum of 3V, where-after subsequent presses once again raise the control voltage in steps of 0.5V.
5. When the desired 'high' airflow is achieved wait 30 seconds without any more button presses. At the end of the 30 second period the controller saves the setting in memory and the fan stops.
6. Hold down the pushbutton and release as soon as the display shows letter 'L'. The indoor fan will start and run at the low speed setting.
7. Repeat steps 3 to 5 to adjust the fan low speed setting. The factory default control voltage for low speed is 5V. The minimum control voltage for low speed is 1V and the maximum control voltage for low speed is 8V. (Note: A 'low' control voltage of less than 2V is not recommended.) If 'low' is set higher than 'high', the 'high' is made equal to 'low'.

Using SAT-3 option

If the unit is controlled with a temperzone SAT-3 wall thermostat then adjustments are made as follows:

1. Activate fan setup mode: Hold down  and '4' button together for 3 seconds.
2. When fan setup mode is active symbol  flashes on and off.
3. Press  OR  to adjust the fan 'low' control voltage up or down.
4. When the desired 'low' voltage is set then press  and repeat step 3 to set the fan 'high' voltage.
5. When adjustment is complete press  to exit fan setup mode.

Using Alternative Thermostats

Follow same procedure as for TZT-100.

Note:

It is allowed to make the control voltages for low and high fan speed equal. This makes the indoor fan act as a fixed speed fan.

It is allowed to control the indoor fan speed by an external source, independent of the UC8 controller. It is then the responsibility of the system-designer

and installer to ensure proper and safe operation of the indoor fan, and the system as a whole, under all operating conditions.

Setting the indoor fan speed too low can bring risk of frost forming on the indoor coil with potential nuisance frost protection trips on cooling, possibly even unit lock-out, and/or HP trips on heating.

Setting the indoor fan speed too high can bring a risk of blowing moisture off the fins of the indoor coil and into the supply air duct. Water could then start leaking from the supply air vents and diffusers and corrosion of ducting may occur.

Setting the indoor fan speed too high can also bring a risk of 'over-condensing' (when the unit is heating) which in turn could cause the unit to perform more outdoor coil de-ice cycles than necessary.

6. OPERATION

6.1 Safety timers

The UC8 receives control signals and transfers the signals to the outputs after enforcing safety timers and other protection functions. If the compressor is held off, or held on, by a safety timer then the display shows message 'H-O-L-D'.

Normal durations of safety timers are:

- Minimum off time 3 minutes
- Minimum run time 1.5 minutes
- Min. cycle time 6 minutes (up to 10 compressor starts per hour)
- Min. mode change-over time 10 minutes (cooling to heating or vice-versa)

6.2 Variable Capacity

The OPA unit is equipped with a single variable capacity compressor – inverter scroll type. DIP switch 14 on the UC8 circuit board can be used to select one of two operating modes:

DIP switch 14	Capacity control mode
OFF	Standard capacity control
ON	Close capacity control

Compressor operating capacities and 0-10V control voltages are:

Compressor type	Minimum		Nominal	Max. / boost mode
	Close control	Standard control		
Inverter	21% (1.6V)	40% (3V)	100% (7.5V)	≈120% (10V)

Note:

At any time, when operating conditions dictate, safety functions can restrict unit operating capacity.

Unless the application requires close control it is recommended the unit be operated in standard capacity control mode.

When a capacity signal is presented that is lower than the minimum capacity (for example 0V on input 'VC') then the compressor operates on minimum duty.

If a unit operates on low capacity for extended periods then the unit may periodically perform oil flush cycles. Under such operating conditions compressor lubricating oil may slowly settle in parts of the refrigeration system other than the compressor; oil flush cycles help to return the lubricating oil to the compressor. During an oil flush cycle compressor capacity is increased to a certain minimum. The duration of an oil flush cycle is 1 minute.

7. CONTROLS

7.1 TZT-100 and SAT-3 wall thermostat

To connect the thermostat to the unit it is recommended to use shielded twisted pair type cable, suitable for RS485 communications. Signals A and B should form one twisted pair.

Note: The cable shield should connect to terminal '0V' on the UC8 controller only. Do not connect at both ends.

Connect the thermostat as follows:

TZT-100 Connection:

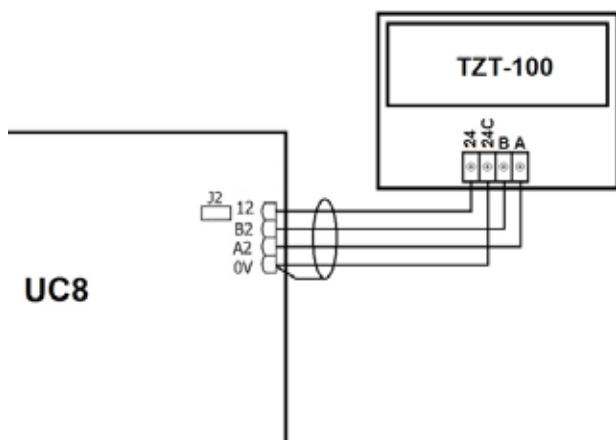

SAT-3 Connection:

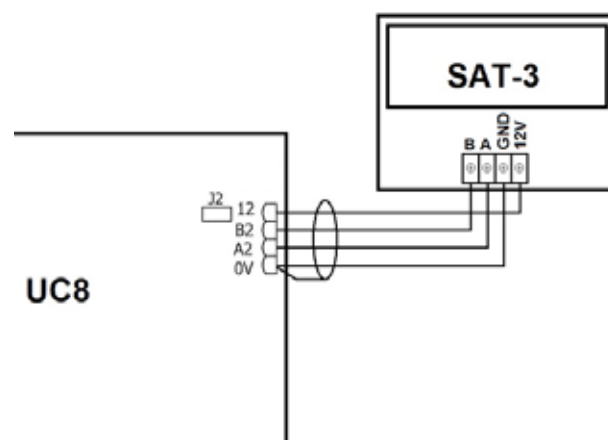

Note: **Capacity Staging.** A TZT-100 or SAT-3 must be configured for single-stage operation, **the default setting.**

TZT-100 has a set of DIP switches that must be set as follows:

DIP switch 2	ON	Equipment type = Heat Pump
DIP switch 3	OFF	Equipment stages = One
DIP switch 4	ON	Reverse cycle valve = Heating

Fault code 36 will appear on the UC8 if the DIP switch settings are incorrect.

Communications format must be set as per recommended Modbus RTU:

- Baud rate (bd or br) 19200
- Data bits 8
- Parity Even
- Stop bits (Pa) 1
- TZT-100 address (Ad) 7
- SAT-3 address (Ad) 8

TZT-100: The procedure to check and adjust these settings is:

1. Press and hold the O/RIDE button until the display shows the PIN
2. Use the UP & DOWN buttons to select PIN code 88:21, then press O/RIDE in installer mode.
3. Use the O/RIDE and PROG buttons to cycle through the various installer settings.

If necessary, refer TZT-100 User Manual for more detail.

SAT-3: The procedure to check and adjust these settings is:

1. Press and hold the MODE and 6 button until the display shows the 'i' symbol.
2. Use the UP & DOWN buttons to cycle through the various installer settings.
3. Press MODE button to save any new setting.

If necessary, refer SAT-3 Installation Guide for more detail.

7.2 Control using switched and 0-10V signals

An external controller that provides 24V AC switched signals or has a set of voltage-free relay contacts should be connected as per the diagram below. UC8 input 'VC' will accept a 0-10V capacity control signal. If no capacity control signal is available then link UC8 terminals 'VC' and '12'. It is necessary to configure the UC8 controllers in the unit as master and slave; refer Section 7.1 and follow steps 1, 2 & 4.

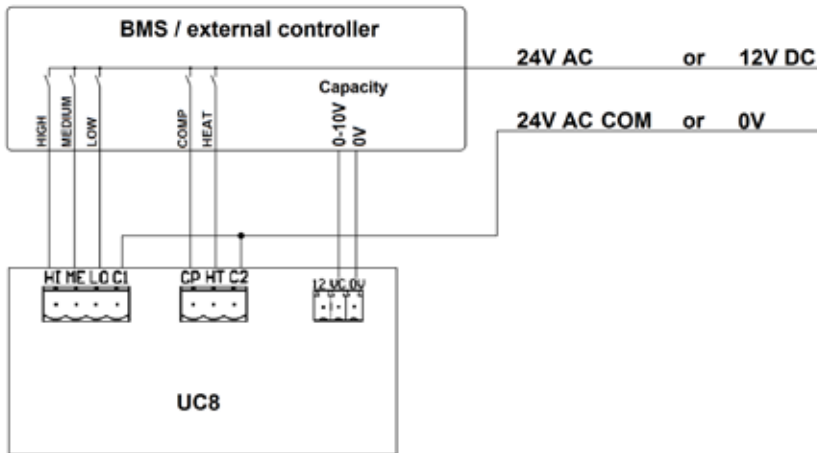

7.3 Control via Modbus RTU communications

Single or multiple OPA units can be fully monitored and controlled via Modbus RTU serial communications. The following is typical for most installations:

- Set DIP switches 11 and 12 OFF on all UC8 controllers.
- Connect BMS terminal A / TX+ to terminal A1 on all UC8 controllers.
- Connect BMS terminal B / TX- to terminal B1 on all UC8 controllers.

It is recommended to 'daisy-chain' the A&B connections using shielded twisted pair type cable, suitable for RS485 communications. Signals A and B should form one twisted pair. The cable shield should connect to terminal '0V' on the UC8 controller.

Multiple OPA units: To avoid collisions of messages on the RS485 serial communications cable it is necessary to ensure each connected UC8 controller has a unique Modbus device address. Refer to section 7.4 for the procedure.

Example:

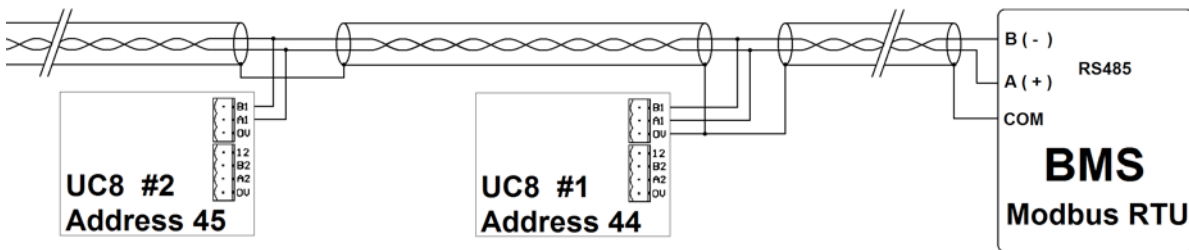

For detailed information about monitoring and control via Modbus RTU refer to document "UC8 Modbus communications", available free on the temperzone internet website.

7.4 Setting the UC8 Modbus device address

To view or change the Modbus device address of a UC8 follow these steps:

- Power up the unit but leave the compressor off.
- Hold down the pushbutton on the UC8, release the button as soon as the display shows the letter 'A'.
- The display will show the current Modbus device address. The factory default address is 44. Press the button to select higher numbers, for example press once to change the address to 45, press twice for address 46 and so forth. After address 99 the number returns back to 1.
- When the desired address is selected wait for 30 seconds. The controller will save the selected address in memory.

7.5 Economiser Option

The Economiser package that is factory fitted consists of two opposed blade dampers, one for the fresh air and the other for the return air with individual damper motors controlled by 0 – 10V ac signals. The package also includes a weatherhood assembly that is usually supplied as a separate item for fitting on site.

It is important that the installation instructions for the fitting of the weatherhood are followed otherwise it is possible some water ingress from rain could occur.

The damper control will be factory wired such that the return air damper will close proportionally as the fresh air damper opens proportionally and vice versa. The fresh air damper's adjustable stop can be set such that it does not close 100%. Many installations may require a minimum fresh air introduction of 10 – 15% and the stop may be set on site to facilitate this. Ensure the air flow is equal between full Return air and full Economiser by adjusting the damper stops on both Return and Fresh air dampers.

A 0 – 10Vac control signal is required to drive the dampers open and closed. This could be from a BMS or a temperature/humidity controller.

It is recommended that control is by Enthalpy (or by a combination of dry and wet bulb temperatures) so that free cooling is used without adding any heat load to the building. Control by dry bulb temperature alone is not recommended as often, even though the outdoor dry bulb temperature may be lower than that of the space, the total heat content of the air can be higher thereby adding heat load in the form of moisture content to the space.

If dry bulb temperature is used as the control method the temperature must be set several degrees lower than the space temperature to reduce the possibility of extra heat load being introduced.

Air Quality (CO₂) sensors can be used to proportionally control the fresh and return air dampers (via the control system).

In all situations the UC8 Unit Controller will allow the compressors to operate with the economizer fresh air damper open providing the refrigeration system is not compromised.

The compressor(s) could be stopped from operating by normal protection devices such as low suction temperature/pressure or indoor coil frost protection and too many trips of either fault could lead to a lock out of the compressor(s) operation. Should this occur then a review of the control settings may be necessary.

8. MAINTENANCE

WARNING! HAZARDOUS VOLTAGE. ENSURE ALL POWER SUPPLIES ARE ISOLATED BEFORE PERFORMING MAINTENANCE. FAILURE TO ISOLATE POWER CAN LEAD TO SERIOUS INJURY.

8.1 Monthly

1. Check air filters, if fitted, and vacuum or wash clean as necessary.
2. Check condensate drain for free drainage.
3. Check compressor compartment for oil stains indicating refrigerant leaks.
4. Check system operating pressures via the UC8 (refer Section 5.2.5).

8.2 Six Monthly

1. Check the tightness of electrical connections.
2. Check for signs of corrosion on electrical connections in high salt atmospheres; replace where necessary.
3. Check the tightness of all fans, motor mountings
4. Check system operating pressures via the UC8 (refer Section 5.2.5).

5. Check and/or replace indoor air filters

6. Check condensate drain for free drainage.

8.3 Yearly

1. Check all refrigerant piping for chafing and vibration.
2. Check the operation of electric heaters, if fitted
3. Check air supply at all diffusers
4. Check for excessive noise and vibration and correct as necessary.
5. Check for insulation and duct damage and repair as necessary.
6. Check system operating pressures via the UC8 (refer Section 5.2.5).
7. Remove lint and dust accumulation from outdoor coil fins with soft brush or low pressure water spray.
8. Touch up any paintwork damage to prevent corrosion.

9. TROUBLESHOOTING

9.1 Room temperature varies significantly from its setting

- Unit may have been incorrectly sized for the building.
- Drafts from wrongly placed supply air diffusers or from the back of the wall plaque could be affecting the temperature sensor built into the wall plaque.
- Poor air circulation in the room can cause incorrect temperature readings.

9.2 Air conditioner does not seem to deliver the heating when most needed

- Heating capacity at design conditions may be incorrect. As the outside temperature falls, heat losses through the walls, floor and ceiling increase.
- Check the unit's brochure for information on the minimum/ maximum operating temperatures.

9.3 When heating, units have de-icing cycles built in to remove ice on the outdoor coil.

- This usually means reversing the cycle for a few minutes during which time there is no heating and in fact a little cooling can occur.

9.4 In a new building, why does it take some days before the air conditioning heat hump unit seems to work properly

- Many new buildings, especially a commercial buildings, have a large amount of concrete and other structural materials that are generally cold and full of moisture. This is most evident in the winter when trying to heat the building from scratch.

9.5 Unit is leaking water

- Check the drain trap/vent/slope.
- Water carry-over: Reduce the maximum fan speed.

9.6 Air conditioner runs excessively – the temperature remains too hot in summer or too cold in winter.

- Windows or doors may be opened to non conditioned areas.
- Keep doors to unconditioned areas closed.
- Leaves, papers or other items blocking air flow over the outdoor unit coil.
- Location of wall controller or remote temperature sensor is incorrect.
- Check for leaks in supply or return air ductwork.

9.7 Outdoor unit displays an error code:

- Refer to UC8 Controller label on the unit for operation & fault diagnostics information or visit www.temperzone.biz; model search 'UC8'.

10. WARRANTY

Please refer to the separate warranty document supplied with the unit, or visit www.temperzone.biz for details.

Australia:

warranty@temperzone.com.au

spares@temperzone.com.au







Telephone: 1800 21 1800

New Zealand:

customerservices@temperzone.co.nz

Telephone: 0800 TZWARRANTY (899 2777)

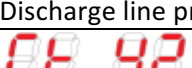
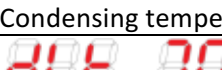
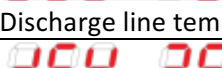
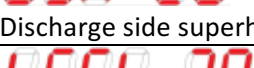
Table 1, Information available on the UC8 display.

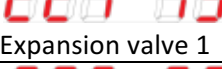
Item	Unit	Abbreviation	Examples
Compressor suction line pressure	kPa	SLP	 Suction line pressure 1034 kPa
Evaporating temperature	°C	Et	 Evaporating temperature 12°C
Compressor suction line temperature	°C	SLt	 Suction line temperature 18°C
Compressor suction side superheat	K	SSH	 Suction side superheat 6K
Compressor discharge line pressure	kPa	dLP	 Discharge line pressure 2447 kPa
Condensing temperature	°C	Ct	 Condensing temperature 42 °C
Compressor discharge line temperature	°C	dLt	 Discharge line temperature 70°C
Compressor discharge side superheat	K	dSH	 Discharge side superheat 28K
De-ice sensor temperature (located on fins of the outdoor coil)	°C	ICEt	 De-ice sensor temperature 39°C
Capacity	%	CAP	 Capacity 100%
Expansion valve 1 opening	%	EE1	 Expansion valve 1 75% open
Expansion valve 2 opening	%	EE2	 Expansion valve 2 75% open

APPENDIX I

PROTECTION FUNCTIONS

The UC8 implements system protection functions such as indoor coil frost, extreme high and low pressures, rapid on-off cycling of the compressors, loss of refrigerant and more.

The following applies to all protection functions except where otherwise indicated:

Unit operating capacity may automatically be reduced before a protection function is activated. Such a reduction may be sufficient to prevent an actual trip from occurring.

When a compressor is stopped by a protection function it is held off for a period of 3 minutes, after which it is allowed to restart (provided the cause of the trip has cleared).

When a protection function is active and when a unit is locked out the alarm relay output “FLT” is active.

More detailed information about protection functions and troubleshooting refer to document “UC8 troubleshooting information”, available for free download from the temperzone internet website.

1 High pressure protection (HP)

OPA unit is fitted with high pressure switches. These switches connect to UC8 inputs IN#1. When a high pressure switch activates (the electrical circuit opens) then the compressor is stopped.

OPA unit is fitted with high pressure transducers connected to UC8 input HPT. The compressor is switched off when the discharge line pressure reading exceeds 4238 kPa.

The display shows the letters ‘HP’ when protection is active.



2 Low pressure protection (LP)

OPA unit is fitted with low pressure switches. These switches connect to UC8 inputs IN#2. When a low pressure switch activates (the electrical circuit opens) then the compressor is stopped.

OPA unit is fitted with low pressure transducers connected to UC8 input LPT. The compressor is switched off when the suction line pressure reading falls below 228 kPa.

The display shows the letters ‘LP’ when protection is active.



3 Indoor coil frost protection

When the unit is cooling the evaporating temperature in the indoor coil should remain above -8°C. If this temperature falls below -8°C then ice (frost) likely will form on the indoor coil. If the low temperature persists for longer than 6 minutes then the protection function activates.



When indoor coil frost protection is activated the compressor is stopped for 6 minutes, after which it is allowed to restart.

4 High discharge line temperature protection

The controller monitors the compressor discharge line temperature via a sensor connected to input ‘DL’ (red wires). The compressor is stopped when:

- The temperature rises above 110°C for longer than 30 minutes.
- The temperature rises above 120°C (immediate action).

The display shows the message ‘Hi-t’ when protection is active.



5 High discharge superheat protection

Discharge superheat is defined as the difference between the compressor discharge gas temperature and the condensing temperature. When this temperature differential becomes very high it is an indication that the compressor is being starved of refrigerant gas. Common reasons for this could be a lack of refrigerant (under-charged or loss-of-charge) or a problem with the expansion device (for example a stuck accumulator or loose wiring to an EEV).

The protection is activated when discharge superheat exceeds 45K for longer than 30 minutes.

The display shows the message ‘Hi-dSH’ when protection is active.



6 Low discharge superheat protection

Discharge superheat is defined as the difference between the compressor discharge gas temperature and the condensing temperature. When this temperature differential stays very low it can be an indication that the compressor is being flooded with liquid refrigerant. Common reasons for this could be an excess of refrigerant (over-charged) or a problem with the expansion device (for example a stuck accumulator or loose wiring to an EEV).

The protection is activated when discharge superheat remains below the threshold for longer than 15 minutes. The threshold varies linearly from 0K at standard mode minimum capacity (40%) to 10K at nominal capacity (100%).

This protection function is disabled when a compressor operates at less than standard mode minimum capacity (< 40%).

The threshold for a variable speed compressor operated in boost mode (capacity above 100%) is fixed at 10K.

The display shows the message ‘LO-dSH’ when protection is active.



7 High evaporation temperature / high suction line temperature protection

When the unit has a low pressure transducer connected to the compressor suction line then the controller calculates the evaporating temperature from the suction line pressure reading. If the unit does not have a low pressure transducer then the controller finds the evaporating temperature via a coil temperature sensor (input IC when the unit is cooling, input OC when the unit is heating, yellow wires). Additionally the controller monitors the compressor suction line temperature via a sensor connected to input ‘SL’ (white wires).

The protection function stops the compressor when:

- The evaporating temperature remains above 27.5°C for longer than 15 minutes.
- The suction line temperature remains above 30°C for longer than 15 minutes.

The display shows the message ‘Hi-SL’ when protection is active.



8 Other alarms

The controller performs many other protection functions. For example:

- Signals from sensors and transducers must remain inside normal operating range.

- Modbus RTU communications with connected devices (e.g. TZT-100 or SAT-3 thermostat, a Carel Power+ inverter) must continue uninterrupted.
- Modbus RTU communications with a controller such as a BMS that is controlling the unit must continue uninterrupted.

Refer to document 'UC8 Troubleshooting Guide' for details.

9 Lock-out

Each protection function has a trip counter. A trip counter is reset to 0 whenever the compressor run request is removed. Any trip that has occurred more than 12 hours ago is removed from the trip count. For some protection functions, when the trip counter reaches value 3 (i.e. three consecutive trips occur) then the unit is "locked out".

When a unit is locked out the compressor is not allowed to start. Lock-out is designed to protect the compressor from repeatedly starting when a serious fault exists that requires the attention of a service technician.

The display shows the code of the fault that caused the lock-out condition.

A unit that is locked out can be unlocked using any one of the following methods:

- Remove mains power from the unit for at least 3 seconds, then restore power.
- Issue an 'unlock' command via Modbus RTU serial communications.
- Reset the controller via Modbus RTU serial communications.

APPENDIX II

AIR HANDLING PERFORMANCE

Note: Airflows are for a dry coil. Reduce airflow by 10% in high moisture removal conditions. In a free blow or low resistance application, beware of exceeding indoor fan motor's full load amp limit (refer Specification page). As filters are optional, the fan air flows given are for units installed without filters.

OPA 296RKTf-P

