

TECHNICAL CATALOGUE

MONO SPLIT

RAK-VJ25PHAT
RAK-VJ35PHAT



RAC-VJ25PHAT
RAC-VJ35PHAT



HITACHI

**Specifications in this catalogue are subject to change without prior notice in order for
HITACHI to bring in the latest innovations to their customers**

**Whilst every effort is made to ensure that all dimensions and specifications are correct, any
printers' error not rectified are outside the control of HITACHI, who cannot be held responsible
for the same**

CONTENTS

CONTENTS	1
1 SPECIFICATIONS	2
2 DIMENSIONAL DATA	4
3 CAPACITIES TABLE	6
3.1. CAPACITY CHARACTERISTIC CURVES	6
3.2. CORRECTION FACTORS ACCORDING TO PIPING LENGTH	8
3.3. CORRECTION FACTORS ACCORDING TO DEFROSTING OPERATION	9
4 SOUND DATA	10
5 WORKING RANGE	12
5.1. POWER SUPPLY	12
5.2. WORKING RANGE	12
6 ELECTRICAL DATA	13
6.1. INDOOR UNIT	13
6.2. OUTDOOR UNIT	13
7 WIRING DIAGRAM	14
8 REFRIGERANT CYCLE	16
9 CONTROL AND FUNCTION	17
9.1. RC-AGU1EA0G	17
9.2. HOW TO SET UP FROM SERVICE SETTING MODE	18
9.3. HOW TO OPERATE THE HHRC METHOD	19
9.4. SERVICE SETTING ITEM USED FOR HHRC	20
9.5. BUZZER SOUNDING FOR SHOWING ERROR CONTENTS	22
9.6. OTHER SETTING	23
9.7. ERROR CODE INFORMATION	23
9.7.1. HOW TO DISPLAY ERROR CODE	23
9.7.2. HOW TO REMOVE ERROR CODE	25
10 OPTION LIST	26
10.1 WIRED REMOTE CONTROL	26
10.1.1 SHIFT VALUE	26
10.1.2 ERROR CODE INFORMATION	27
10.2 H-LINK ADAPTOR	29
10.2.1 SAFETY SUMMARY	29
10.2.2 INSTALLATION WORK	29
10.2.3 ELECTRICAL WIRING	30
10.2.4 DIP SWITCH SETTING	31
10.2.5 TEST RUN	32
10.3 DRY CONTACT APPLICATION	33

1 SPECIFICATIONS

1.1. WALL TYPE

INDOOR	Unit	RAK-VJ25PHAT	RAK-VJ35PHAT
Nominal capacity adjustable		no	no
Nominal Cooling capacity (min - max)	kW	2.50 (1.00 - 3.50)	3.50 (1.00- 4.20)
Cooling sensible capacity	kW	2.20	2.85
Nominal Heating capacity (min - max)	kW	3.20 (1.00- 5.00)	3.80 (1.00- 5.30)
Heating capacity (H2)	kW	3.4	4.0
Noise level cooling (sound pressure) (SL / L / M / H / SH)	dB(A)	20/24/33/38/40	20/26/36/41/42
Noise level heating (sound pressure) (SL / L / M / H / SH)	dB(A)	20/23/34/39/41	22/27/36/42/44
Noise level (sound power)	dB(A)	54	56
Air flow cooling mode (SH / H / M / L / SL)	l / Sec	167/148/97/67/65	185/165/115/77/65
Air flow heating mode (SH / H / M / L / SL)	l / Sec	202/195/133/100/77	233/209/162/128/86
Fan Motor	W	18	18
Dehumidification	l/h	1.4	1.6
Dimensions (H x W x D)	mm	280 x 780 x 227	280 x 780 x 227
Weight	kg	8.6	8.6
Colour		star white *ZYY8001	star white *ZYY8001
Condensate Drain	mm	φ16	φ16
Running current (C/H) (Rated)	A	1.09~5.30 (2.64) / 1.09~5.30 (2.61)	1.09~6.09 (3.60) / 1.09~6.96 (3.20)
Power supply		230~240V/1Ph/50Hz	230~240V/1Ph/50Hz
Cable section (interconnection)	mm ²	1.50x 3+EARTH/-	1.50x 3+EARTH/-
Piping diameter (Liq / Gas)	Inch	1/4" / 3/8"	1/4" / 3/8"
Drain diameter (ext)	mm	φ16	φ16
Remote control (standard/optional)		RC-AGS1EA0E/ RC-BGH1FA0G	RC-AGS1EA0E/ RC-BGH1FA0G
Filter			
ACL Filter (standard/optiona/optiona)		Anti Virus Filter / PM2.5 Treatment+Nano Titanium Active Carbon Filter / PM2.5 Treatment+Nano Titanium Wasabi Filter	Anti Virus Filter / PM2.5 Treatment+Nano Titanium Active Carbon Filter / PM2.5 Treatment+Nano Titanium Wasabi Filter
ACL part name		RFUAP005/RFUG8A689/RFUG8A601	RFUAP005/RFUG8A689/RFUG8A601
Pre-filter(Standard/Optional)		STAINLESS /-	STAINLESS /-

NOTE:

1. The nominal cooling and heating capacity is the combined capacity of the HITACHI standard split system, and are based on the EN 14511.

Operation Conditions		Cooling	Heating
Indoor Air Inlet Temperature	dB	27.0 °C	20.0 °C
	WB	19.0 °C	15.0 °C
Outdoor Air Inlet Temperature	dB	35.0 °C	7.0 °C
	WB	24.0 °C	6.0 °C
Piping Length: 5.0 meters; Piping Lift: 0 meter dB: Dry Bulb; WB: Wet Bulb			

2. The Sound Pressure Level is based on the following conditions:

- 0.8 meter beneath indoor height center
- 1 meter from Discharge grille

The above data was measured in an anechoic chamber. Please take into consideration reflected sound of your specific site

1.2. WALL TYPE

OUTDOOR	Unit	RAC-VJ25PHAT	RAC-VJ35PHAT
Nominal Cooling capacity (min - max)	kW	2.50 (1.00 - 3.50)	3.50 (1.00- 4.20)
Nominal Heating capacity (min - max)	kW	3.20 (1.00- 5.00)	3.80 (1.00- 5.30)
Nominal cooling power input (min - max)	kW	0.485 (0.250 - 1.220)	0.825(0.250 - 1.400)
Nominal heating power input (min - max)	kW	0.620(0.250 - 1.200)	0.765(0.250 - 1.600)
EER / COP		5.15/5.16	4.24/4.97
TCSPF/HSPF(HOT/MIXED/LOLD)		Cooling(7.869/7.114/7.244) Heating(5.508/5.167/4.734)	Cooling(6.924/6.410/6.743) Heating(5.438/5.073/4.667)
STARS(HOT/MIXED/LOLD)		Cooling(6.0/5.5/5.5) Heating(4.0/3.5/3.0)	Cooling(5.0/4.5/5.0) Heating(3.5/3.5/3.0)
Noise level cooling (sound pressure)	dB(A)	46	48
Noise level heating (sound pressure)	dB(A)	48	50
Noise level (sound power)	dB(A)	60	62
Air flow (Cooling / Heating)	m ³ /h	1860/1620	1920/1620
Dimensions (H x W x D)	mm	600×792×299	600×792×299
Weight	kg	36.5	36.5
Colour (Munsell Code)		Beige (5Y7/2)	Beige (5Y7/2)
Power supply	V/Ph/Hz	220~240V/1Ph/50Hz	220~240V/1Ph/50Hz
Recommended fuse size	A	15	15
Cable section (power)	mm ²	1.50x 2+EARTH	1.50x 2+EARTH
Cable section (Interconnection)	mm ²	1.50x 3+EARTH	1.50x 3+EARTH
Piping diameter (Liq / Gas)	Inch	1/4" / 3/8"	1/4" / 3/8"
Minimum piping length	m	3	3
Maximum piping length / height difference	m	20 / 15	20 / 15
Current quantity of refrigerant / Chargeless	kg	0.980	0.980
Chargeless length / Additional refrigerant charge	m / g/m	20/-	20/-
Working range (cooling / heating)	°C	-10°C—46°C/-15°C—24°C	-10°C—46°C/-15°C—24°C
Refrigerant		R32	R32
Condenser Fan		Propeller Fan	Propeller Fan
Compressor	Type		ROTARY
	Oil Charge	mL	320±20
	Oil Type		ACS-68R or equivalent
	Coil resistance	Ω	1.354 at 20°C
	Quantity		1

NOTE:

1. The Sound Pressure Level is based on the following conditions:

- 1 meter from the unit front surface and 1 meter from floor level

The above data was measured in an anechoic chamber. Please take into consideration reflected sound of your specific site

2 DIMENSIONAL DATA

2.1. WALL TYPE: RAK-VJ25PHAT,RAK-VJ35PHAT

Unit: mm

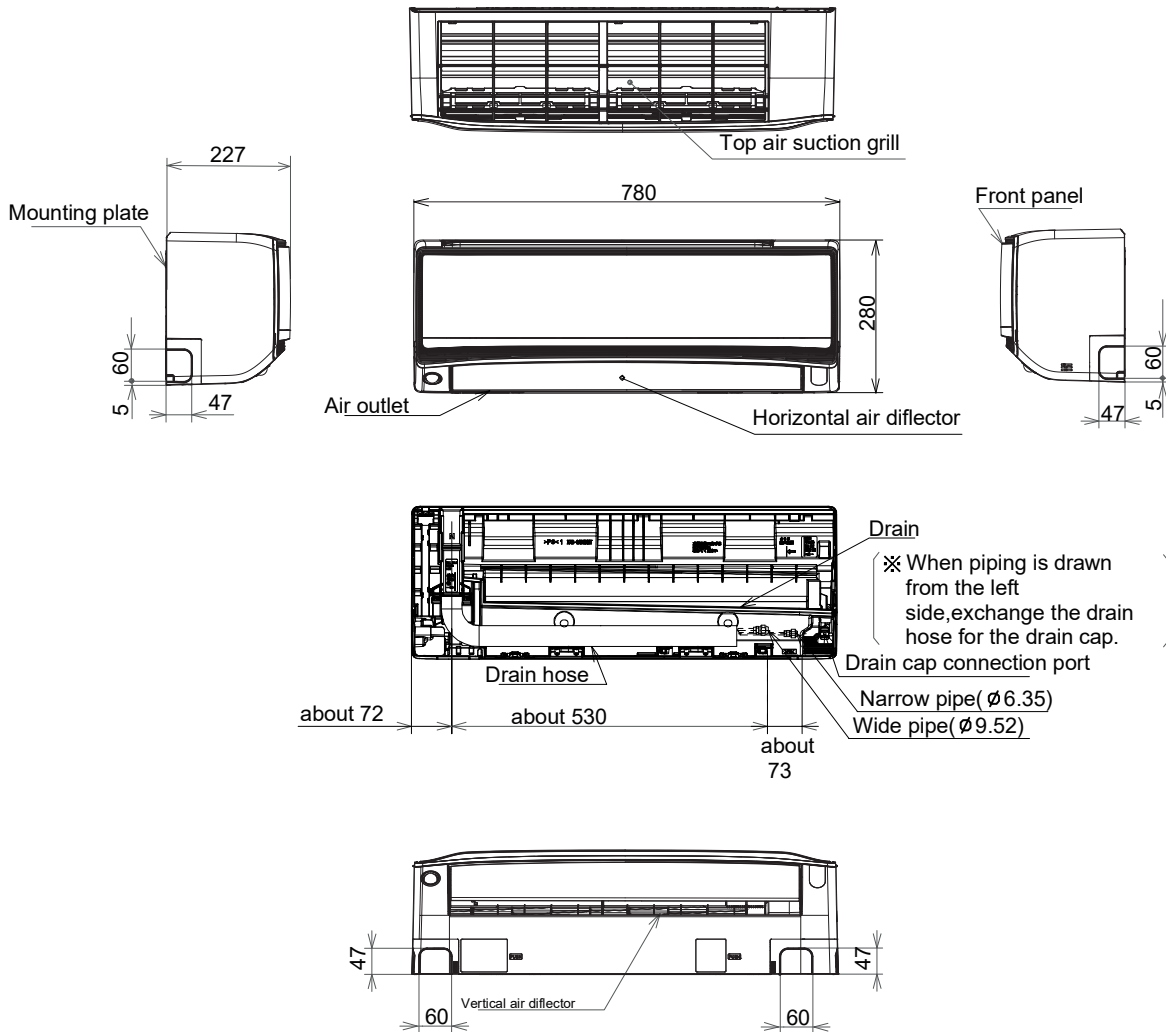

2.2. WALL TYPE: RAC-VJ25PHAT,RAC-VJ35PHAT

Unit : mm

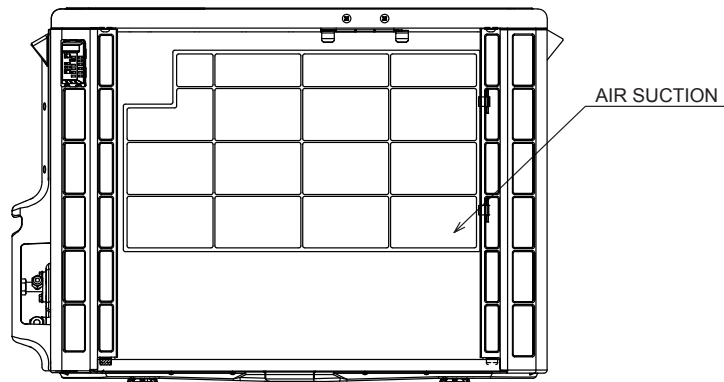
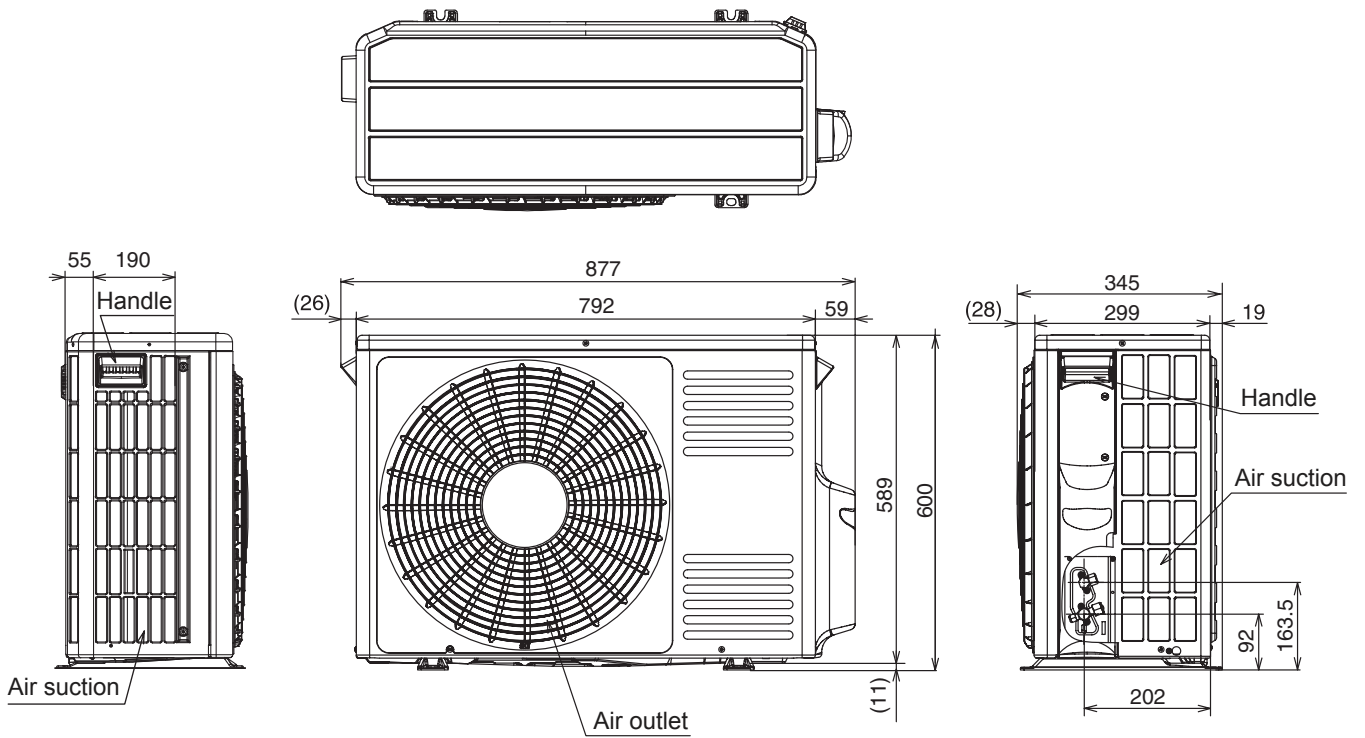

View from the rear

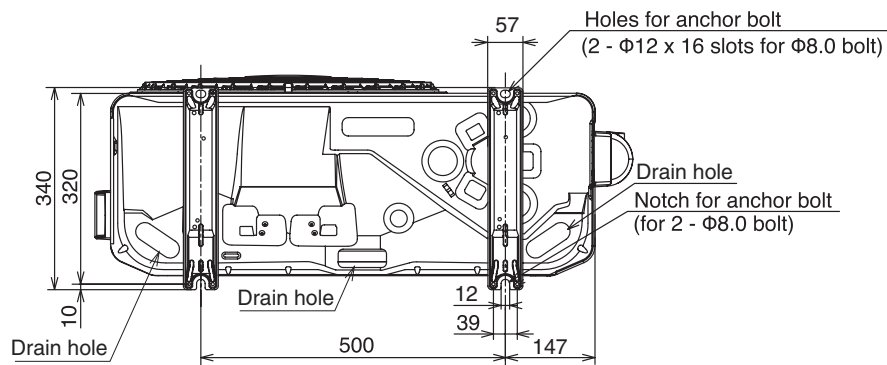

3 CAPACITIES TABLE

3.1. CAPACITY CHARACTERISTIC CURVES

The following charts show the characteristics of outdoor unit capacity, which corresponds with the operating ambient temperature of outdoor unit.

Conditions:

① Pipe length / height difference : 5m / 0m

③ Compressor at rated inverter frequency

② Indoor fan speed at High mode

④ Capacity loss due to white frost and defrost operation is not included.

3.1.1. RAK-VJ25PHAT/RAC-VJ25PHAT

COOLING [50Hz, 230V]

INDOOR		OUTDOOR TEMPERATURE (°CDW)																				
EWB	EDB	-10			21			27			32			35			40			43		
°C	°C	TC	SHC	PI	TC	SHC	PI	TC	SHC	PI	TC	SHC	PI	TC	SHC	PI	TC	SHC	PI	TC	SHC	PI
12.0	18	1779	1471	247	2110	2055	308	1953	1896	363	2050	2002	446	1975	1914	466	1850	1804	500	1775	1716	519
14.0	20	1779	1471	247	2267	2055	308	2110	1916	367	2200	2002	451	2125	1936	470	1975	1804	504	1900	1738	529
16.0	22	1779	1565	251	2424	2055	312	2245	1916	371	2350	2002	456	2275	1936	480	2125	1804	514	2050	1738	534
18.0	25	1907	1678	255	2582	2232	316	2380	2074	376	2500	2178	461	2400	2090	480	2250	1958	519	2150	1870	538
19.0	27	1971	1735	259	2671	2351	320	2469	2173	380	2600	2288	466	2500	2200	485	2350	2068	519	2250	1980	538
22.0	30	2186	1716	259	2963	2331	320	2739	2153	380	2875	2266	470	2775	2178	490	2500	2112	538	2325	2068	567
24.0	32	2336	1716	263	3165	2331	324	2918	2153	384	3075	2266	470	2950	2178	495	2600	2156	553	2375	2134	587

HEATING [50Hz, 230V]

INDOOR		OUTDOOR TEMPERATURE (°CDW)																					
EDB	-15	-10			-7			-5			0			7			10			15			
°C	TC	SHC	PI	TC	SHC	PI	TC	SHC	PI	TC	SHC	PI	TC	SHC	PI	TC	SHC	PI	TC	SHC	PI		
16	2232		888	2545		919	2740		930	2818		878	3001		759	3237		571	3423		587	3759	612
18	2216		894	2529		925	2720		940	2795		891	2976		772	3218		596	3405		613	3730	641
20	2200		900	2513		931	2700		950	2771		903	2950		785	3200		620	3388		639	3700	670
22	2184		906	2497		937	2680		960	2748		915	2924		798	3182		644	3370		664	3670	699
24	2168		912	2481		944	2660		970	2725		927	2899		811	3163		669	3352		690	3641	728

EWB : Evaporator Wet Bulb temperature (°C)

EDB : Evaporator Dry Bulb temperature (°C)

(°CDB) : Outdoor Unit Inlet Air Dry Bulb Temperature (°C)

TC : Total Capacity (W)

SHC : Sensible Heating Capacity (W)

PI : Power Input

3.1.2. RAK-VJ35PHAT/RAC-VJ35PHAT

COOLING [50Hz, 230V]

INDOOR		OUTDOOR TEMPERATURE (°CDW)																				
EWB	EDB	-10			21			27			32			35			40			43		
°C	°C	TC	SHC	PI	TC	SHC	PI	TC	SHC	PI	TC	SHC	PI	TC	SHC	PI	TC	SHC	PI	TC	SHC	PI
12.0	18	1909	1461	323	2632	2371	466	2436	2189	550	2870	2594	759	2765	2480	792	2590	2337	850	2485	2223	883
14.0	20	1909	1461	323	2828	2371	466	2632	2212	566	3080	2594	767	2975	2508	800	2765	2337	858	2660	2252	899
16.0	22	1909	1554	328	3024	2371	473	2800	2212	563	3290	2594	776	3185	2508	817	2975	2337	875	2870	2252	908
18.0	25	2047	1667	333	3220	2576	479	2968	2394	569	3500	2822	784	3360	2708	817	3150	2537	883	3010	2423	916
19.0	27	2116	1723	338	3332	2713	485	3080	2508	576	3640	2964	792	3500	2850	825	3290	2679	883	3150	2565	916
22.0	30	2346	1704	338	3696	2690	485	3416	2485	576	4025	2936	800	3885	2822	833	3500	2736	916	3255	2679	965
24.0	32	2507	1704	343	3948	2690	491	3640	2485	582	4305	2936	800	4130	2822	842	3640	2793	941	3325	2765	998

HEATING [50Hz, 230V]

INDOOR		OUTDOOR TEMPERATURE (°CDW)																							
EDB	°C	-15			-10			-7			-5			0			7			10			15		
°C	°C	TC	SHC	PI	TC	SHC	PI	TC	SHC	PI	TC	SHC	PI	TC	SHC	PI	TC	SHC	PI	TC	SHC	PI	TC	SHC	PI
16	2838			1185	3276		1216	3548		1226	3598		1150	3711		975	3844		705	4104		720	4570		744
18	2819			1192	3257		1224	3524		1238	3570		1166	3680		991	3822		735	4083		752	4535		779
20	2800			1200	3238		1231	3500		1250	3543		1181	3650		1008	3800		765	4063		784	4500		815
22	2781			1208	3219		1239	3476		1262	3515		1196	3620		1024	3778		795	4042		815	4465		851
24	2762			1215	3200		1247	3452		1274	3488		1211	3589		1040	3756		825	4021		847	4430		886

EWB : Evaporator Wet Bulb temperature (°C)
 EDB : Evaporator Dry Bulb temperature (°C)
 (°CDB) : Outdoor Unit Inlet Air Dry Bulb Temperature (°C)

TC : Total Capacity (W)
 SHC : Sensible Heating Capacity (W)
 PI : Power Input

3.2. CORRECTION FACTORS ACCORDING TO PIPING LENGTH

Correction Factor for Cooling Capacity according to Piping Length

The cooling capacity should be corrected according to the following formula:

$$CCA = CC \times F$$

- CCA: Actual Corrected Cooling Capacity (kcal/h)
- CC: Cooling Capacity in the Performance Table (kcal/h)
- F: Correction Factor Based on the Equivalent Piping Length

Correction Factor for Heating Capacity according to Piping Length

The heating capacity should be corrected according to the following formula:

$$HCA = HC \times F$$

- HCA: Actual Corrected Heating Capacity (kcal/h)
- HC: Heating Capacity in the Performance Table (kcal/h)
- F: Correction Factor Based on the Equivalent Piping Length

The correction factors are shown in the following figure.

Equivalent Piping Length for:

- One 90° Elbow is 0.5m.
- One 180° Curve is 1.5m.

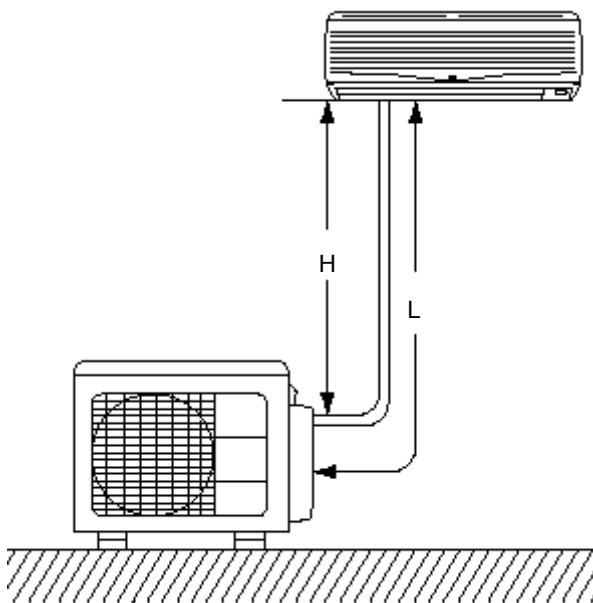

- H: Vertical Distance Between Indoor Unit and Outdoor Units in Meters
- L: Actual One-Way Piping Length Between Indoor Unit and Outdoor Unit in Meters
- EL: Equivalent Total Distance Between Indoor Unit and Outdoor Unit in Meters (Equivalent One-Way Piping Length)

Models : RAK-VJ25PHAT/RAC-VJ25PHAT, RAK-VJ35PHAT/RAC-VJ35PHAT

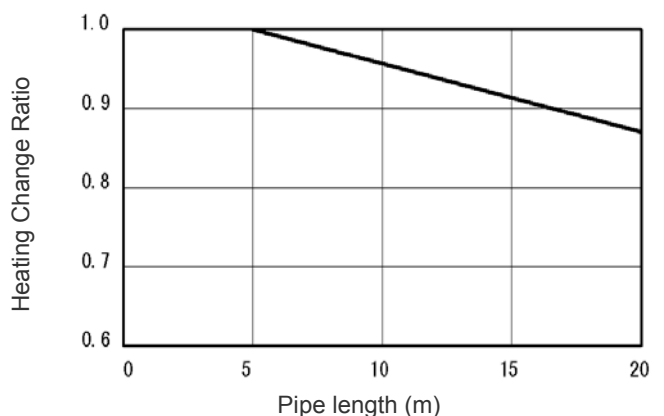
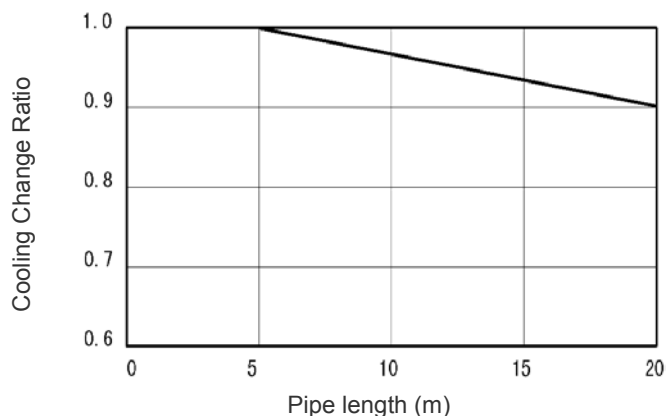

3.3. CORRECTION FACTORS ACCORDING TO DEFROSTING OPERATION

The heating capacity in the preceding paragraph, excludes the condition of the frost or the defrosting operation period. In consideration of the frost or the defrosting operation, the heating capacity is corrected by the equation below.

Corrected heating capacity = Defrost Correction factor x unit capacity

OUTDOOR TEMPERATURE (°CDB)	-15	-10	-5	0	7	10	15
Correction factor (humidity rate 85% RH)	0.85	0.85	0.85	0.85	1.0	1.0	1.0

Correction Factor

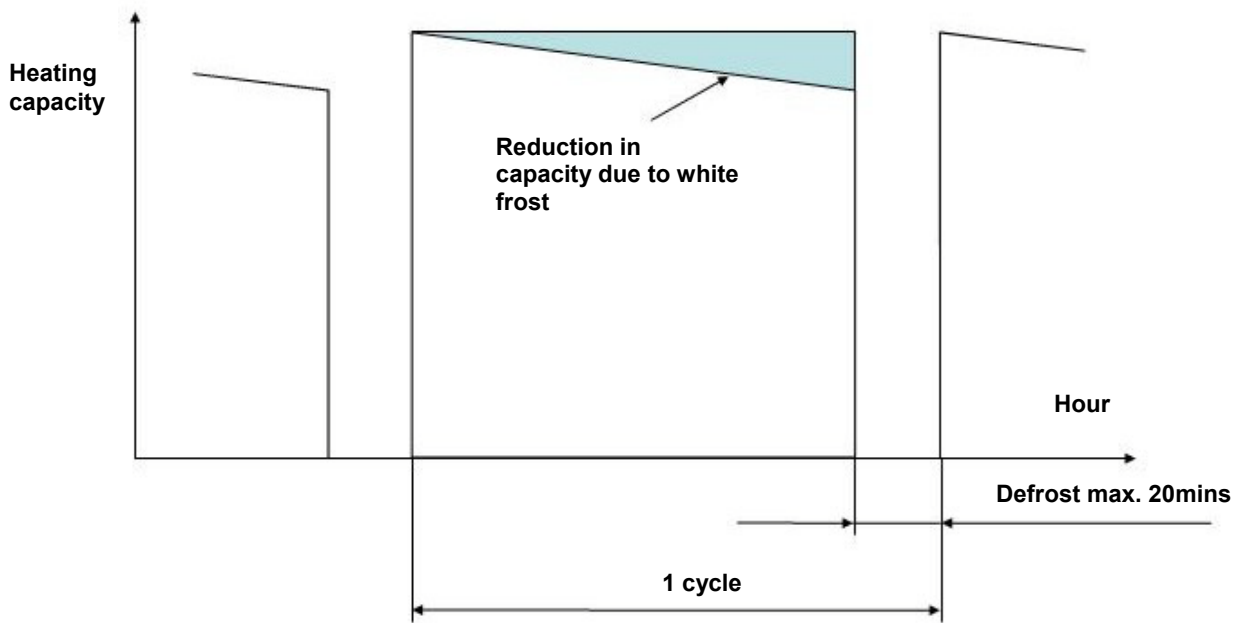

NOTE:

The correction factor is not valid for special conditions such as snowfall or operation in a transitional period.

4 SOUND DATA

4.1. RAC-VJ25PHAT

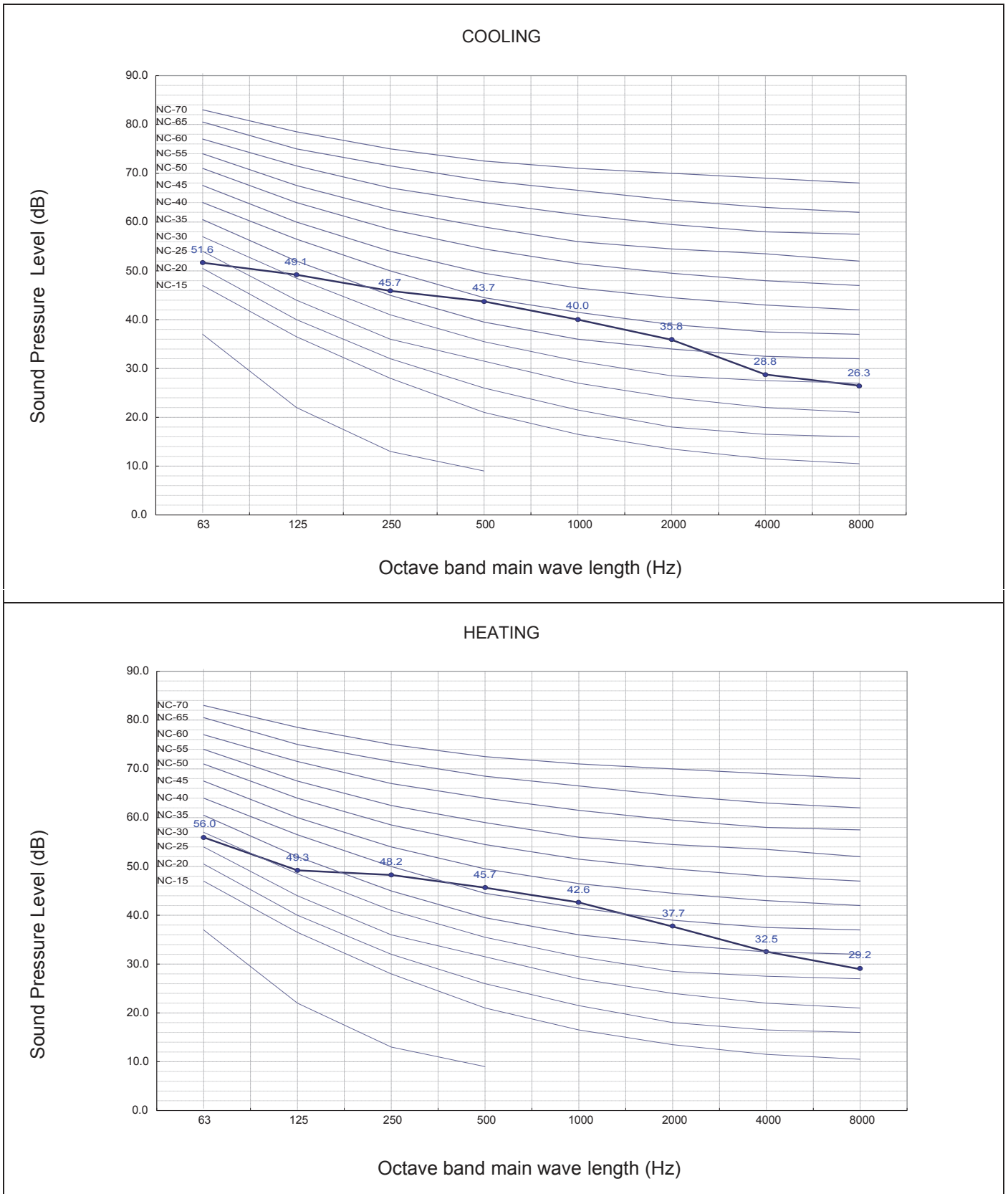

The Sound Pressure Level is based on the following conditions:

1 meter from the unit front surface and 1 meter from floor level

The above data was measured in an anechoic chamber. Please take into consideration reflected sound of your specific site

4.2. RAC-VJ35PHAT

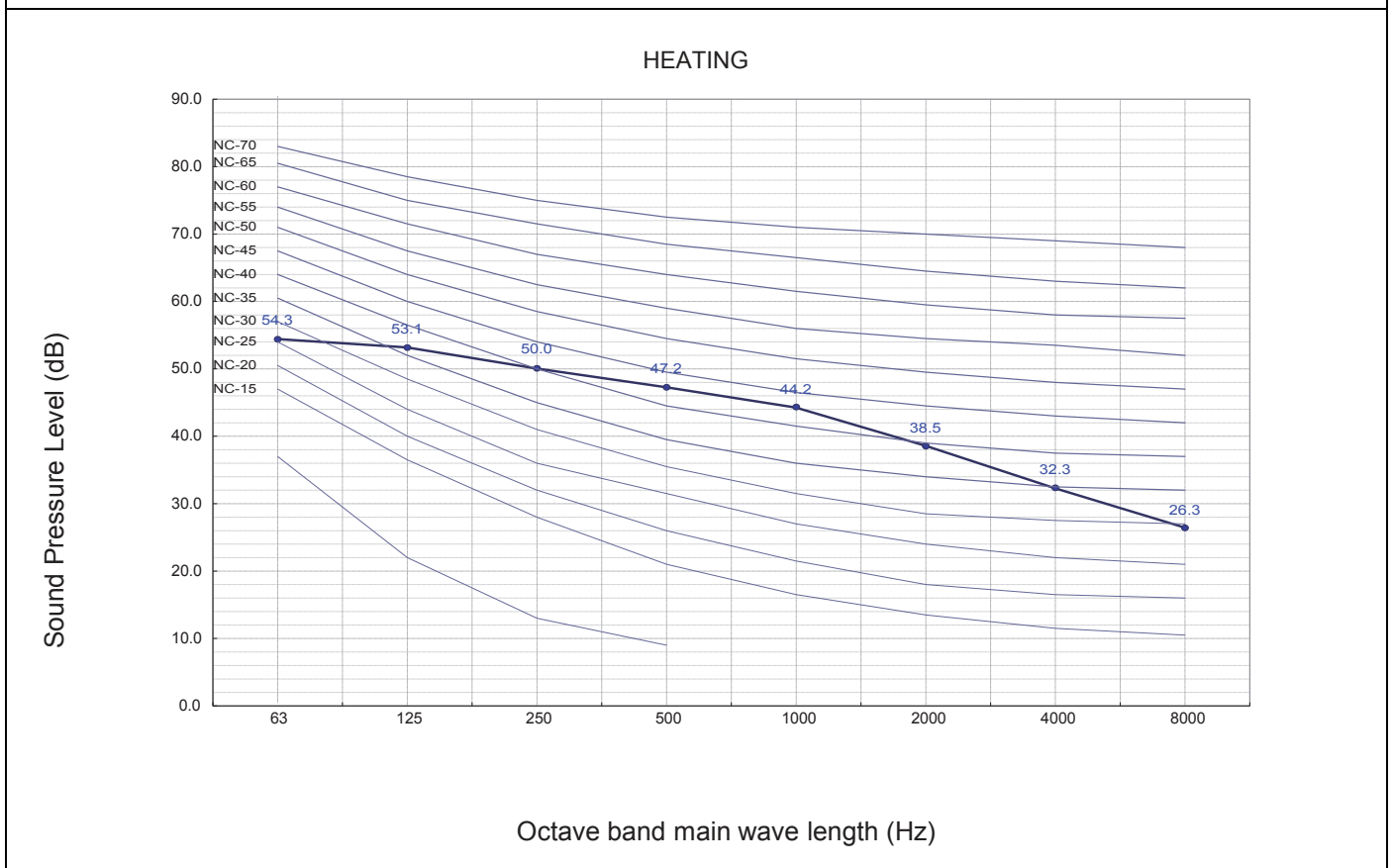
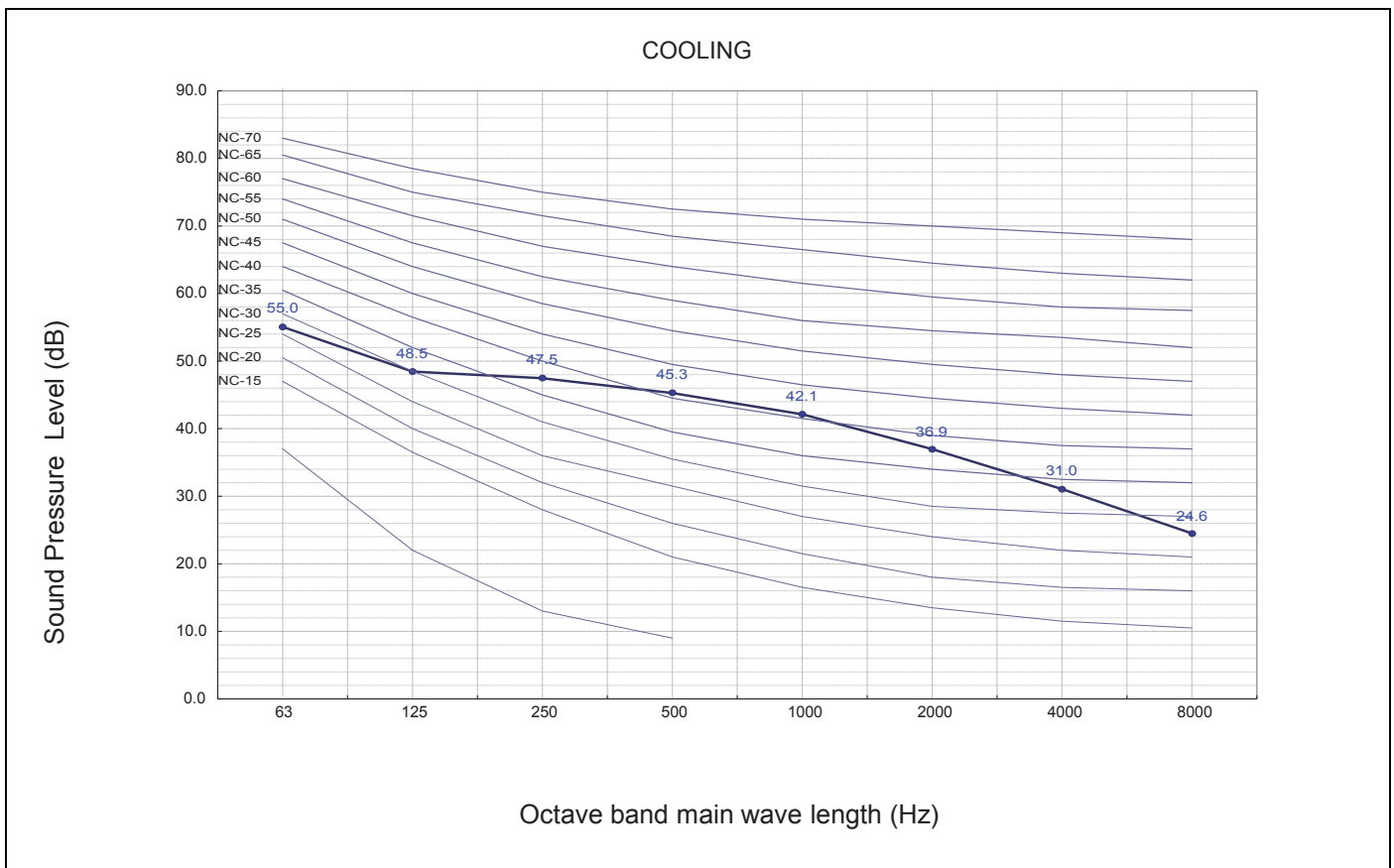

The Sound Pressure Level is based on the following conditions:

1 meter from the unit front surface and 1 meter from floor level

The above data was measured in an anechoic chamber. Please take into consideration reflected sound of your specific site

5 WORKING RANGE

5.1. POWER SUPPLY

Working Voltage	198V ~ 269V
Voltage Imbalance	Within a 3% Deviation from Each Voltage at the Main Terminal of Outdoor Unit
Starting Voltage	Higher than 85% of the Rated Voltage

5.2. WORKING RANGE

Applicable models:

RAC-VJ25PHAT
RAC-VJ35PHAT

The temperature range is indicated in the following table.

Cooling

working range	min (°C)	max (°C)	rated (°C)
outdoor	-10	46	35
indoor	16	32	27

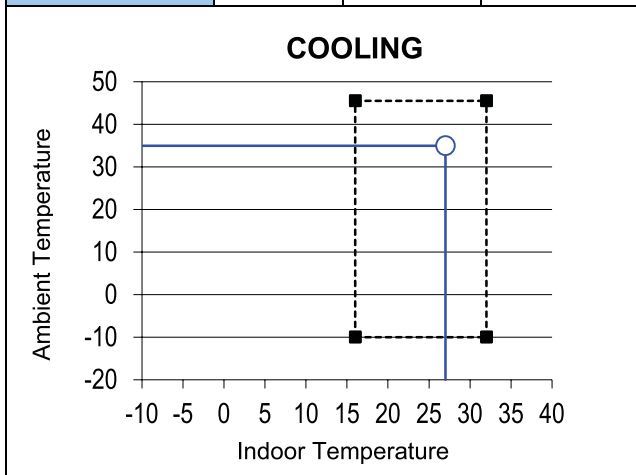

Heating

working range	min (°C)	max (°C)	rated (°C)
outdoor	-15	24	7
indoor	16	26	20

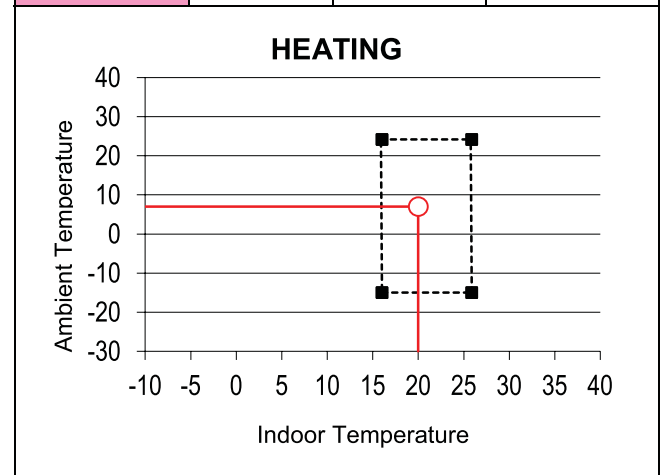

6 ELECTRICAL DATA

6.1. INDOOR UNIT

Model	Unit Main Power		Applicable Current		Indoor Fan Motor	
	VOL, PH, Hz	Fuse Rating (A)	Max Current	RNC	RNC	IPT
RAK-VJ25PHAT	220 ~ 240, 1, 50	3.15	5.5	(C):2.64 (H):2.61	(C):0.04 (H):0.06	(C):11.8 (H):16.2
RAK-VJ35PHAT	220 ~ 240, 1, 50	3.15	7.5	(C):3.60 (H):3.20	(C):0.05 (H):0.09	(C):14.1 (H):22.9

VOL: Rated Unit Power Supply Voltage (V)

Hz: Frequency (Hz)

RNC: Running Current (A)

PH: Phase (ϕ)

IPT: Input (W)

6.2. OUTDOOR UNIT

Model	Unit Main Power				Compressor Motor				
	VOL, PH, Hz	Fuse Rating (A)	Min (V)	Max (V)	Locked Rotor Ampere(A)	Cooling Operation		Heating Operation	
						RNC	IPT	RNC	IPT
RAC-VJ25PHAT	220 ~ 240, 1, 50	15	198	264	-	2.64	485	2.61	620
RAC-VJ35PHAT	220 ~ 240, 1, 50	15	198	264	-	3.60	825	3.2	765

VOL: Rated Unit Power Supply Voltage (V)

HZ: Frequency (Hz)

RNC: Running Current (A)

PH: Phase (ϕ)

IPT: Input (W)

NOTE:

1. The above compressor data is based on 100% capacity combination of indoor units at the rated operating frequency
2. This data is based on the same conditions as the nominal heating and cooling capacities.
3. The compressor started by an inverter, resulting in extremely low starting current.

7 WIRING DIAGRAM

7.1. RAK-VJ25/35PHAT

EE0024706A

WIRING DIAGRAM

BLK:BLACK YEL:YELLOW
 BLU:BLUE GRN:GREEN
 RED:RED WHT:WHITE
 GRY:GRAY BRN:BROWN

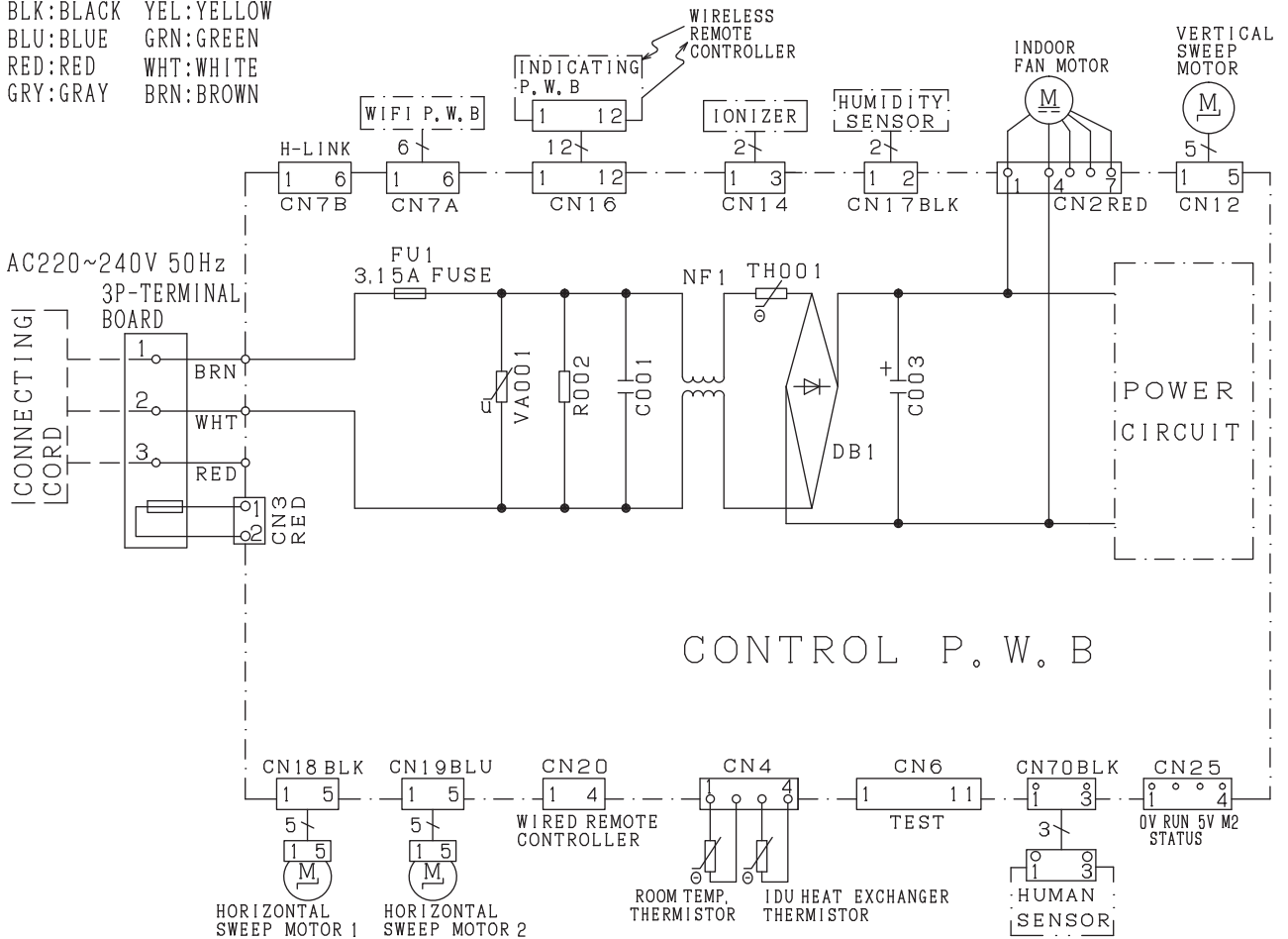

CAUTION! HIGH VOLTAGE TURN OFF THE POWER SOURCE DURING THE SERVICE WORK.

※ SOME MODELS NOT NEED TO INSTALL WIFI P.W.B , IONIZER , HUMAN SENSOR

7.2. RAC-VJ25/35PHAT

[WIRING DIAGRAM]

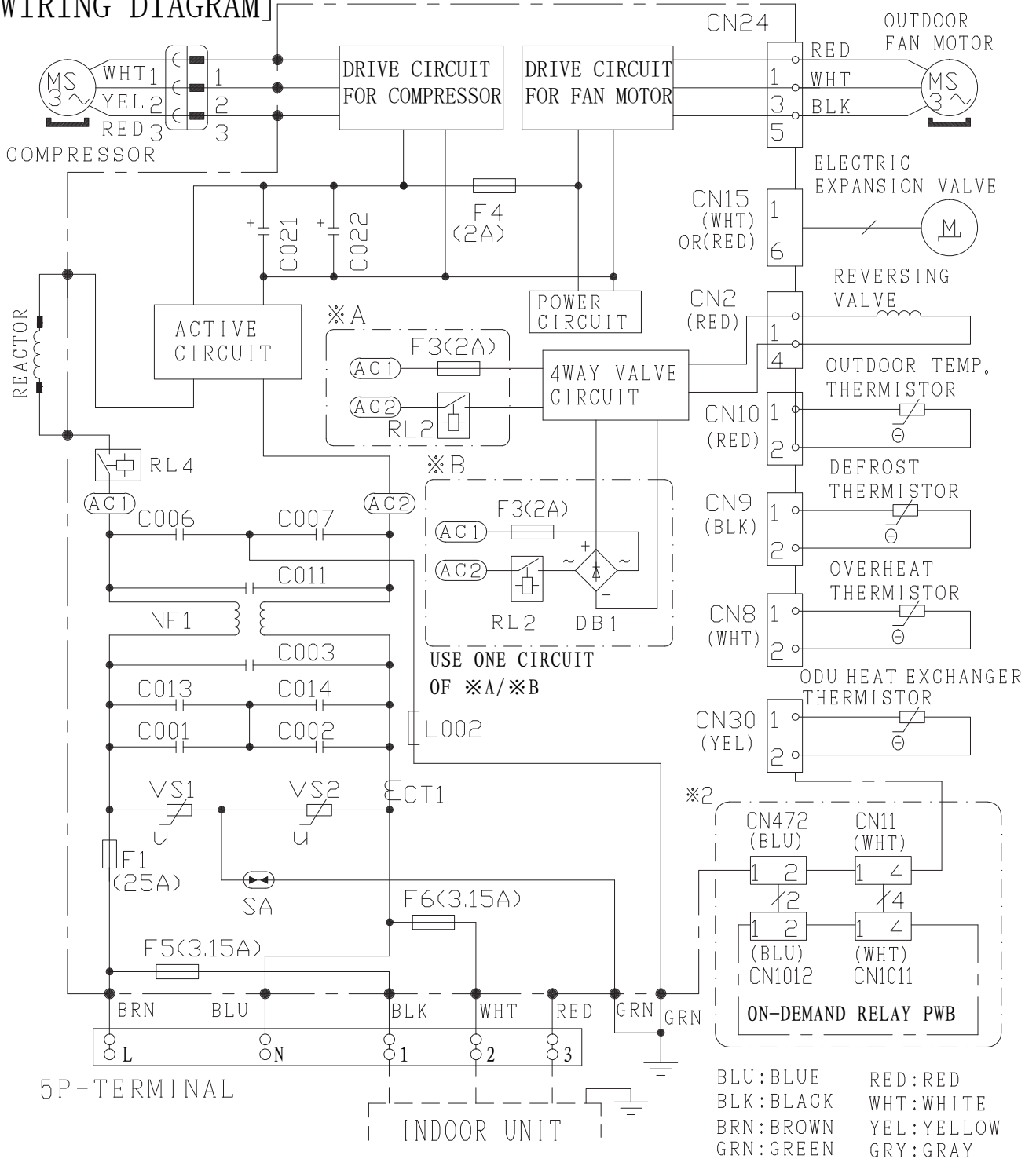

8 REFRIGERANT CYCLE



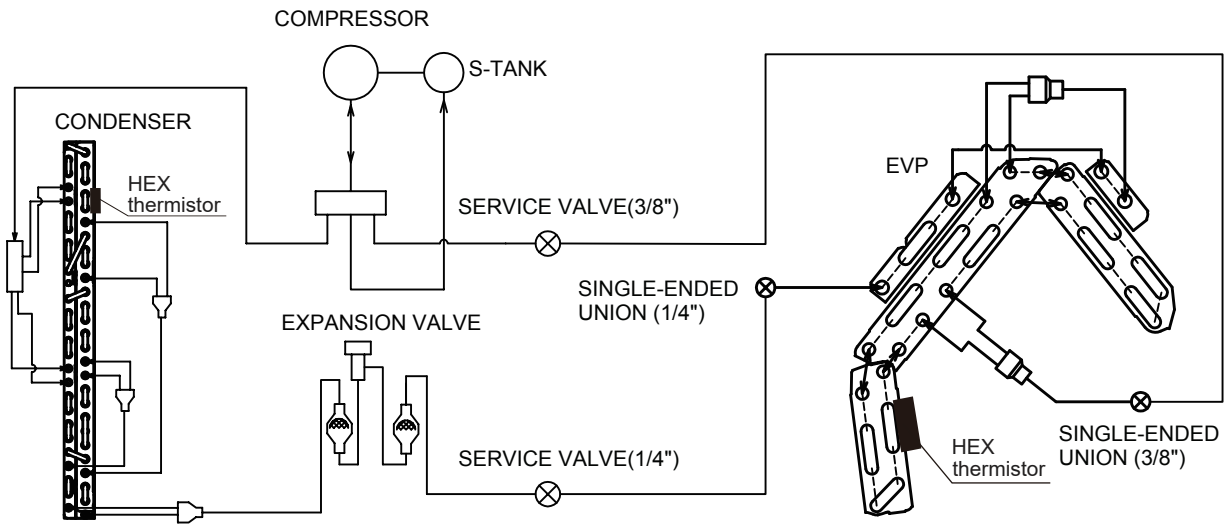





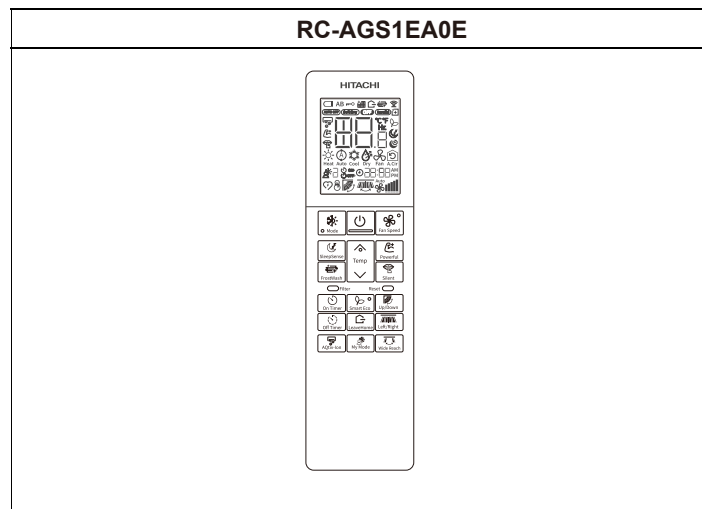













8.1. WALL TYPE : RAK-VJ25PHAT/RAC-VJ25PHAT, RAK-VJ35PHAT/RAC-VJ35PHAT



9 CONTROL AND FUNCTION

9.1. RC-AGS1EA0E



BUTTONS	FUNCTION
	Mode Selector Button Use this button to select the operation mode. Every time you press this button the mode will change from  (Heat) →  (Auto) →  (Cool) →  (Dry) →  (Fan) cyclically.
	SleepSense Button Control set temperature and fan speed.
	Temperature Button Room temperature setting. Value will change quicker when keep pressing.
	FrostWash Button Dust and dirt are being removed by freezing and thawing on the heat exchanger.
	Fan Speed Button Select the fan speed.
	On/Off Button Press this button to start operation. Press it again to stop operation.
	Powerful Button The air conditioner performs at maximum power.
	Silent Button The fan speed changes to the silent fan speed
	On Timer Button Select the turn ON time.
	Off Timer Button Select the turn OFF time.
	Smart Eco Button Use this button to set the Smart Eco mode.
	LeaveHome Button Prevent the room temperature from falling too much by setting temperature 10°C~16°C when no one is at home.
	Up/Down Button Control the angle of the horizontal air deflector.
	My Mode Button Use this mode for personalized comfortable settings. The My Mode can be set by using the remote controller. Up to 3 programs can be set.
	Left/Right Button Control the angle of the Vertical air deflector.
	Wide Reach Button Control the angle of the Vertical air deflector.
	AQ-tiv-ion Button

For more information, please refer to the operation manual.

9.2. How to set up from Service setting mode

The Service function, which was set by DIP-SW setting or double pressing of the HHRC in the current model. it will be done by HHRC in GRAC as shown as below.

[On timer] + [Fan speed] + [Reset]
(Press three Key for 5 seconds to avoid access by User)

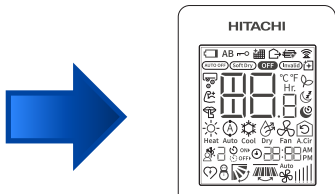
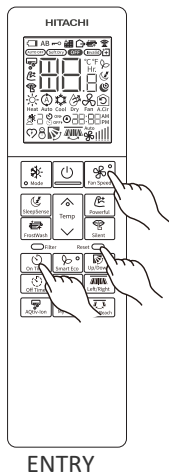

All icon ON for 2 Seconds

Layer1
(category selection):
Installation



Layer2
(function selection):
Card key



Layer3
(setting select):
Disable



Fan speed : Current Layer

※ If you don't do anything for 30 seconds, you will be out of the service setting mode.

9.3. How to operate the HHRC method

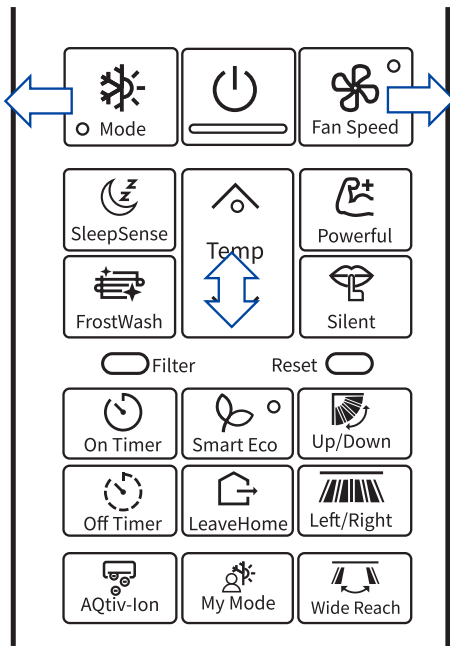

Temp Δ ∇ : Selection (in the same layer)
 Mode : move to previous layer
 Fan Speed : Move to next layer
 ON/OFF : Decision/Send (at layer 3)
 : Current setting check(at layer 2)
 Filter: category initialization(at layer 1)
 Filter + ON/OFF: all category initialization(at layer 1)
 ※ To exit from this setting mode, you need to either not operate the HHRC panel for 30 seconds or press and hold the UP/Down key for 5 seconds.

Layer 1
(category selection)

Layer 2
(Function selection)

Layer 3
(Setting select)

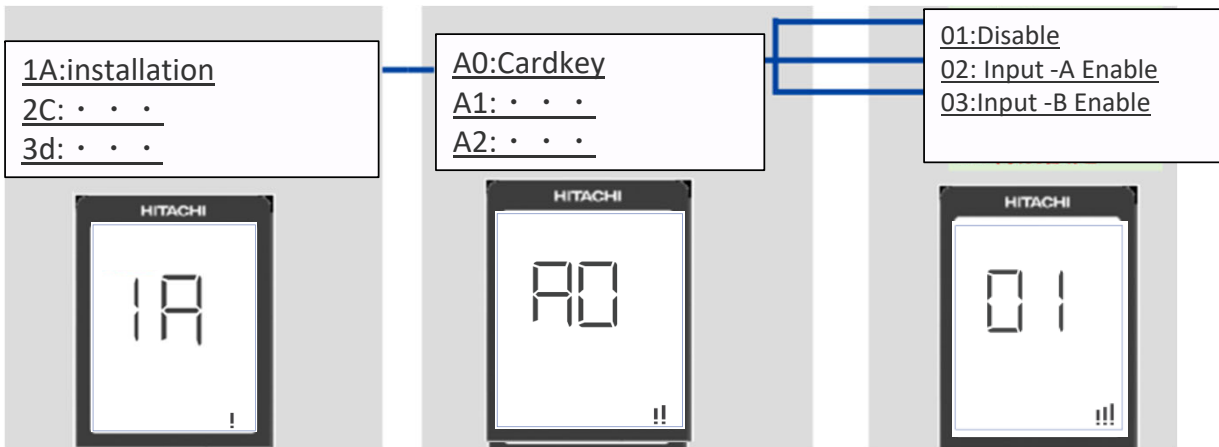

9.4. Service setting item used for HHRC (Wireless remote model: RC-AGS1EA0E)

Category	Function	Display on LCD Temperature 7 segment Layer Wise			Value setting meaning at Layer-3
		1	2	3	
Installation	Card Key	1A	A0	01	1 - Card Key Input - Disable
				02	2 - Contact A Enable
				03	3 - Contact B Enable
				04-99	4-99 : Reserved
	Heating/Cooling only mode select - (Operation Mode Lock)	1A	A1	01	1 - Normal Mode
				02	2 -Cooling Lock (Cool,Dry,A.circulator,Fan mode available)
				03	3 - Heating Lock (Heat and Fan mode available)
				04-99	4-99 : Reserved
	Auto restart switchover(Standard)	1A	A2	01	auto restart changeover disable
02				auto restart by previous mode	
03-99				3-99 : Reserved	
Clean	Outdoor Frost wash (Manual) / Fan reverse request (Manual)	2C	C0	01	01 - Start Request
				02-99	Reserved
Cycle Operation	Defrost selection Function	3d	E0	01	01 - Standard Region
				02	02- Cold Region
				03-99	Reserved
	Set temperature shift adjustment (Cooling)	3d	E1	01	Setting Temperature Shift Adjustment (-5°C/-10°F)
				02	Setting Temperature Shift Adjustment (-4°C/-8°F)
				03	Setting Temperature Shift Adjustment (-3°C/-6°F)
				04	Setting Temperature Shift Adjustment (-2°C/-4°F)
				05	Setting Temperature Shift Adjustment (-1°C/-2°F)
				06	Setting Temperature Shift Adjustment (±0°C/±0°F)
				07	Setting Temperature Shift Adjustment (+1°C/2°F)
				08	Setting Temperature Shift Adjustment (+2°C/4°F)
				09	Setting Temperature Shift Adjustment (+3°C/6°F)
				10	Setting Temperature Shift Adjustment (+4°C/8°F)
				11	Setting Temperature Shift Adjustment (+5°C/10°F)
	Set temperature shift adjustment (Heating)	3d	E2	01	Setting Temperature Shift Adjustment (-5°C/-10°F)
				02	Setting Temperature Shift Adjustment (-4°C/-8°F)
				03	Setting Temperature Shift Adjustment (-3°C/-6°F)
				04	Setting Temperature Shift Adjustment (-2°C/-4°F)
				05	Setting Temperature Shift Adjustment (-1°C/-2°F)
				06	Setting Temperature Shift Adjustment (±0°C/±0°F)
				07	Setting Temperature Shift Adjustment (+1°C/2°F)
				08	Setting Temperature Shift Adjustment (+2°C/4°F)
				09	Setting Temperature Shift Adjustment (+3°C/6°F)
				10	Setting Temperature Shift Adjustment (+4°C/8°F)
				11	Setting Temperature Shift Adjustment (+5°C/10°F)
	Indoor fan air speed when cooling thermostat is \odot	3d	E3	01	01 : standard
				02	02 : Cold Region
03-99				Reserved	
Selection of indoor fan control during heating thermo- \odot	3d	E4	01	01 : Fan Control at the Time of Heating Thermo- \odot Pattern 1"	
			02	02 : Fan Control at the Time of Heating Thermo- \odot Pattern 2"	
			03	03 : Fan Control at the Time of Heating Thermo- \odot Pattern 3"	
			04-99	Reserved	

9.4. Service setting item used for HHRC (Wireless remote model: RC-AGS1EA0E)

HHRC	Temperature Resolution change - 0.5°C--> 1°C	6H	P0	01	1 -0.5 °C Resolution 2-1 °C Resolution
	Fan Speed key sequence (Weaker to stronger , stronger to Weaker)	6H	P1	01	1 - Default (Auto-Silent-Low-Med-Hi-H2) 2- Reverse (Hi2-Hi-Med-Lo-Silent-Auto)
	Operation Mode : Auto	6H	P2	2	1-Disable Selection on HHRC by Mode key 2 - Enable Selection on HHRC by Mode Key
	Operation Mode : Cool	6H	P3	02	1-Disable Selection on HHRC by Mode key 2 - Enable Selection on HHRC by Mode Key
	Operation Mode : Dry	6H	P4	02	1-Disable Selection on HHRC by Mode key 2 - Enable Selection on HHRC by Mode Key
	Operation Mode : Fan	6H	P5	02	1-Disable Selection on HHRC by Mode key 2 - Enable Selection on HHRC by Mode Key
	Operation Mode : Heat	6H	P6	02	1-Disable Selection on HHRC by Mode key 2 - Enable Selection on HHRC by Mode Key
	Auto Fan speed : Enable / Disable	6H	P8	02	1 -Disable Selection on HHRC by Fan key 2 - Enable Selection on HHRC by Fan Key
	Fan Speed tapping control	6H	P9	01	1- Normal (Auto,Silent, Low,Med,Hi,H2) Selection on HHRC by Fan key 2- (Auto,Silent,Lo,Med,Hi) Selection on HHRC by Fan key
	RTC and Timer setting Format change: 12 Hr Format / 24 HR Format (Only for RTC based models)	6H	PA	02	1 - 12 Hr Format with AM/PM for RTC and Timer ON, Timer OFF 2 - 24 Hr Format for RTC and Timer ON , Timer OFF
	Cooling Lower limit setting	6H	PC	16	(Lower set temp. start from 16 °C)
				17	(Lower set temp. start from 17 °C)
				18	(Lower set temp. start from 18 °C)
				19	(Lower set temp. start from 19 °C)
				20	(Lower set temp. start from 20 °C)
				21	(Lower set temp. start from 21 °C)
				22	(Lower set temp. start from 22 °C)
				23	(Lower set temp. start from 23 °C)
				24	(Lower set temp. start from 24 °C)
				25	(Lower set temp. start from 25 °C)
26				(Lower set temp. start from 26 °C)	
27				(Lower set temp. start from 27 °C)	
28				(Lower set temp. start from 28 °C)	
29				(Lower set temp. start from 29 °C)	
Heating Upper limit setting	6H	Pd	32	(Upper set temp. start from 32 °C)	
			31	(Upper set temp. start from 31 °C)	
			30	(Upper set temp. start from 30 °C)	
			29	(Upper set temp. start from 29 °C)	
			28	(Upper set temp. start from 28 °C)	
			27	(Upper set temp. start from 27 °C)	
			26	(Upper set temp. start from 26 °C)	
			25	(Upper set temp. start from 25 °C)	
			24	(Upper set temp. start from 24 °C)	
			23	(Upper set temp. start from 23 °C)	
			22	(Upper set temp. start from 22 °C)	
			21	(Upper set temp. start from 21 °C)	
			20	(Upper set temp. start from 20 °C)	
			19	(Upper set temp. start from 19 °C)	
18	(Upper set temp. start from 18 °C)				
17	(Upper set temp. start from 17 °C)				
16	(Upper set temp. start from 16 °C)				
Diagnosis	Failure Indication(latest to last 5 times)	7J	t0	01	1: Failure Display History 1 (Latest of last Five)
				02	2: Failure Display History 2
				03	3: Failure Display History 3
				04	4: Failure Display History 4
				05	5: Failure Display History 5 (5 th Error)
				06-99	Reserved
	Failure Diagnosis Start	7J	t1	01	1 : Failure Diagnosis Start
				02-99	Reserved
	Failure Memory Erase	7J	t2	01	1:Failure Memory Erase
				02-99	Reserved
	Humidity Sensor failure diagnosis	7J	t3	01	1:Humidity ensor failure diagnosis request
				02-99	Reserved

9.5. Buzzer sounding for showing error contents

[Up/Down]

(Press this Key for 5 seconds)

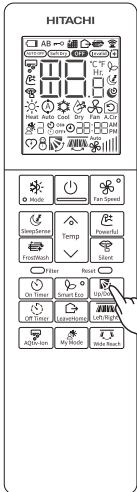

In case of IDU failure



LED action



Timer lamp is blinking

Buzzer action



In case of ODU failure



LED action



Operation lamp is blinking

Buzzer action



Sounding by same rhythm with LED

[note]

- for stopping buzzer, stop by On/Off button, or press Up/Down button for 5 seconds.

<IDU error example: timer LED will blink 3 times(interface defective(IDU) >

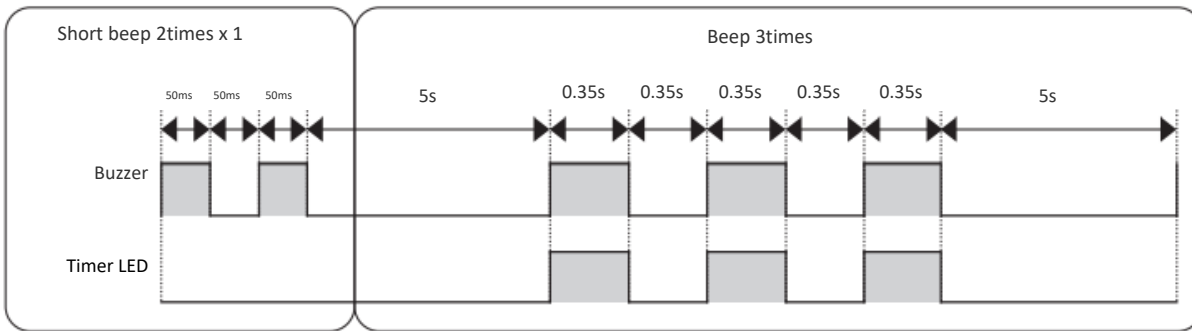

After "Short 2times x 1 beep", "3 times beep" will be repeated.

<ODU error example: operation LED will blink 2 times(peak current cut) >

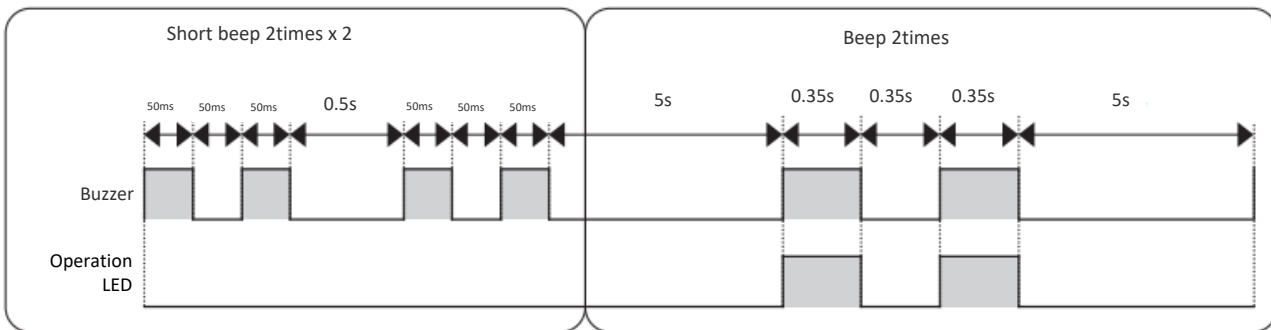

After "Short 2times x 2 beep", "2 times beep" will be repeated.

9.6. OTHER SETTING

▪ ID SELECTION

Case: 2 set of indoor units installed near to each other. If both indoor units can receive the remote controller signal, please set the remote controller as below. (This setting will change the signal address of each remote controller.)

1.The circuit breaker for the unit shall be OFF.

2.Press and holding “UP/Down swing button” and “set. Temp. up button” and “reset button”. Release “reset button” only and when the LCD display “A”.

3.Select from A or B by pressing “set. Temp. button”.

4.Press “On/Off button” toward IDU. (EEPROM in HHRC will keep the A or B information.)

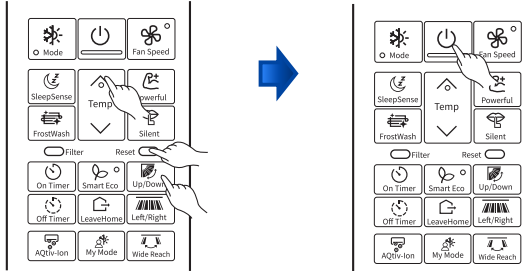

▪ DISPLAY MODE

For operating indoor unit independently (without outdoor unit connection), remote controller has to be set according to below procedures before send the signal to the indoor unit. New communication format between indoor and outdoor is required to communicate with outdoor unit.

1.Press and holding “On Times button” and “On/Off button”, press “reset button” on the same time.

2.Release “reset button” only and make sure that the FAN speed icon  on LCD display.

3.Press “On/Off button” toward IDU.

Then, the indoor unit will starts to operate independently according the selected operation mode.

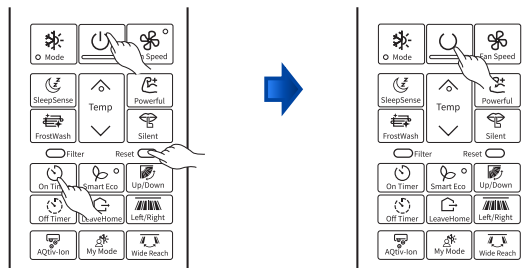



9.7. ERROR CODE INFORMATION

9.7.1. HOW TO DISPLAY ERROR CODE

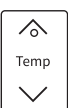
1.Press three key ([On Timer] + [Fan Speed] + [Reset]) button on the remote control for 5 seconds to avoid access by User.

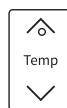
2. Press “” (Temperature) button of the remote control and select the “7J” option.

3. Press “” (Fan Speed) button of the remote control, then Press “” (Temperature) button select the “t0” option.

4. Press “” (Fan Speed) button of the remote control, then Press “” (Temperature) button select the “01” option.

5. Press “” (On/Off) button of the remote control, the fault information will be seen.

Function Name	Value	Layer1	Layer2	Layer3
		Category	Function	Value
Display self-diagnosis memory(※)	Display History 1 (Latest(newest) of last Five)	7J	t0	01
	Display History 2			02
	Display History 3			03
	Display History 4			04
	Display History 5			05

The specific information of error code is shown in the table below:

	TIMER LAMP BLINKING	LD301 BLINKING	CODE	MEANING
INDOOR	-	-	000 00	Normal
	1 time		001 00	Refrigerant cycle fault
	2 times	-	-	Outdoor unit is under forced operation
	3 times	9 times	003 00	Communication error (indoor)
	9 times	-	009 00	Indoor thermistor defective
	10 times	-	010 00	Abnormal rotating numbers of DC fan motor
	12 times	9 times	012 00	Communication error (outdoor)
	13 times	-	013 00	EEPROM data reading error
	20 times	-	020 00	Human sensor defective
	21 times	-	021 00	Interface defective (other machine cause)
	25 times	-	025 00	CN7A/B connection defective

	OPERATION LAMP BLINKING	CODE	MEANING (THE FOLLOW DEFECTIVES IN OUTDOOR UNIT)
INDOOR	2 times	002 01	Peak current cut
	3 times	003 01	Compressor abnormal low speed rotation
	4 times	004 01	Compressor switching failure
	5 times	005 01	Overload lower limit cut
	6 times	006 01	OH thermistor temperature rise
	7 times	007 01	Abnormal outdoor thermistor
	9 times	009 01	Communication error
	10 times	010 01	Abnormal power source
	11 times	011 01	Fan stop for strong wind
	12 times	012 01	Fan motor fault
	13 times	013 01	EEPROM reading error
	14 times	014 01	DC Voltage abnormal
	15 times	015 01	Abnormal PWB circuit
16 times	016 01	High load stop	

9.7.2. HOW TO REMOVE ERROR CODE

1. Press three key ([On Timer] + [Fan Speed] + [Reset]) button on the remote control for 5 seconds to avoid access by User.

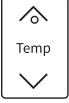
2. Press “” (Temperature) button of the remote control and select the “7J” option.

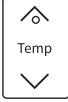

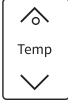

















3. Press “” (Fan Speed) button of the remote control, then Press “” (Temperature) button select the “t2” option.

4. Press “” (Fan Speed) button of the remote control, then Press “” (Temperature) button select the “01” option.





5. Press “” (On/Off) button of the remote control, and the error code will be removed.

10 OPTION LIST

10.1. WIRED REMOTE CONTROL – SPX-RCDB1



 <p>RAR-5G2 (SPX-RCDB1)</p>	BUTTONS	FUNCTION
		MODE Selector Use this button to select the operating mode. Every time you press this button, the mode will change from  (AUTO) →  (HEAT) →  (DEHUMIDIFY) →  (COOL) and →  (FAN) cyclically.
		FAN SPEED Selector Button This determines the fan speed. Every time you press this button, the airflow rate will change from  (AUTO) →  (HIGH) →  (MED) →  (LOW) →  (SILENT) (This button allows selection of optimal or preferred fan speed for each operation mode).
		ON/OFF button Press this button to start operation. Press it again to stop operation.
		SLEEP button Use this button to set the SLEEP timer.
		SET button Timer setting reservation.
		OFF button Select the turn OFF timer.
		ON button Select the turn ON timer.
		CANCEL button Cancel timer reservation.
		AUTO SWING (Vertical) button Controls the angle of the horizontal air deflector.
	ROOM TEMPERATURE setting button Value will change quicke when keep pressing.	

10.1.1. SHIFT VALUE

1. Press and hold  (ON/OFF) button and  (ON TIMER) button at the same time while giving a single press on the RESET button until remote controller now enter 'Shift value change mode'.
2. Press  (ON/OFF) button so that the display indicates  (FAN) speed.
3. Select  (FAN SPEED) button to choose Heating Shift or Cooling Shift Mode.

By setting fan speed to HIGH  or MED  , it will go to Cooling Shift mode.

By setting fan speed to LOW  or SILENT  , it will go to Heating Shift mode.



4. Press  (ROOM TEMPERATURE) button to change the shift value (-3°C ~ 0 ~ 3°C).
5. Press  (ON/OFF) button to end 'Shift value setting mode'.

NOTE:

1. There are total of 7 shift values ranging from -3 to 3.
2. The changed shift value will remain unchanged after turned off the power.

10.1.2. ERROR CODE INFORMATION

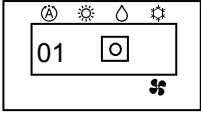
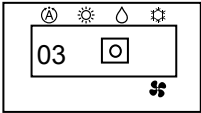
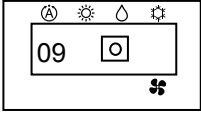
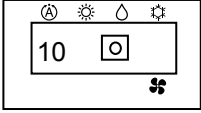
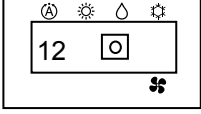
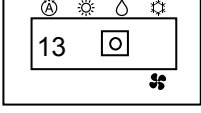
1. In case failure occurs to the air conditioner, the error code will constantly appear on the wired remote controller display.

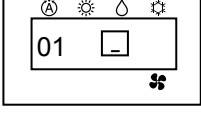
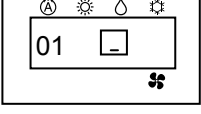
	TIMER LAMP BLINKING	LD301 BLINKING	CODE	MEANING
INDOOR	-	-	-	Normal
	1 time	-		Refrigerant cycle fault
	2 times	-	-	Outdoor unit is under forced operation
	3 times	9 times		Communication error (indoor)
	9 times	-		Indoor thermistor defective
	10 times	-		Abnormal rotating numbers of DC fan motor
	12 times	-		Communication error (outdoor)
	13 times	-		EEPROM data reading error
	21 times	-		Interface defective (other machine cause)
OUTDOOR	4 times	2 times		Peak current cut
	4 times	3 times		Compressor abnormal low speed rotation

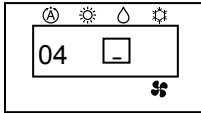
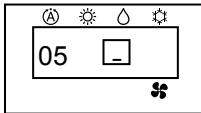
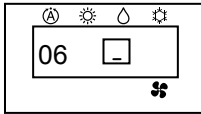
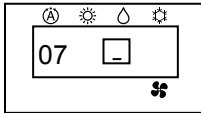
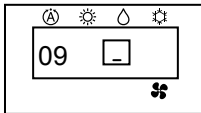
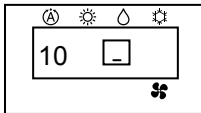
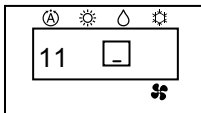
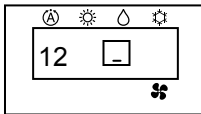
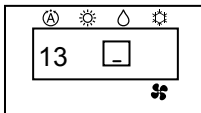
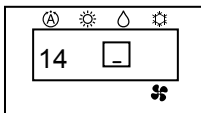
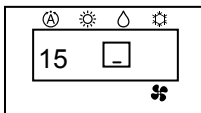
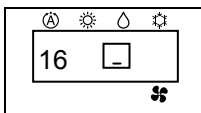
	TIMER LAMP BLINKING	LD301 BLINKING	CODE	MEANING
OUTDOOR	4 times	4 times		Compressor switching failure
	4 times	5 times		Overload lower limit cut
	4 times	6 times		OH thermistor temperature rise
	4 times	7 times		Abnormal outdoor thermistor
	4 times	9 times		Communication error
	4 times	10 times		Abnormal power source
	4 times	11 times		Fan stop for strong wind
	4 times	12 times		Fan motor fault
	4 times	13 times		EEPROM reading error
	4 times	14 times		DC Voltage abnormal
	4 times	15 times		Abnormal PWB circuit
	4 times	16 times		High load stop

10.2. H-LINK ADAPTOR – PSC 6RAD

10.2.1. SAFETY SUMMARY

DANGER:

- DO NOT pour water into the remote control switch (hereafter called “controller”). This product is equipped with electrical parts. This will cause serious electrical shock.

WARNING:

- DO NOT perform installation work and electrical wiring connection by yourself. Contact your distributor or dealer of HITACHI and ask then for installation work and electrical wiring by service person. The specified cable should be used to connect (i) room air conditioner and adaptor, and (ii) controller and adaptor.



CAUTION:



- DO NOT install the indoor unit, outdoor unit, controller and cable as such places as:
 - where there is oil vapor and dispersion of oil
 - where there is sulfuric environment (near the hot springs)
 - where there is a flammable gas
 - where there is salty environment (near the sea)
- DO NOT install the indoor unit, outdoor unit, controller and cable within approximately 3 meters from strong electromagnetic wave radiators, such as medical equipment. In case that the controller is installed in a place where there is electromagnetic wave direct-radiation, shield the controller and cables by covering with the steel box and running the cable through the metal conduit tube.
- In case that there is electric noise at the power source for the indoor unit, provide a noise filter.

10.2.2. INSTALLATION WORK

■ Before installation

Check the contents and the number of the accessories in the packing.

Adaptor	 <p>With two 1.8m cables</p>
1 piece of cover for hiding the covering	 <p>Attached 2 sided tapes</p>
Two-sided tape for attaching to Adaptor	 <p>110x40x3mm</p>

2 connectors for H-Link connection		
2 tapping screws for attaching to wall		φ3.0 x 10mm
2 screws for attaching to wooden wall		φ3.1 x 16mm

- 1) RAC adaptor can be installed to the wall as well as on the air conditioner itself
- 2) Install RAC adaptor in the vertical surface as shown below.

Upper side

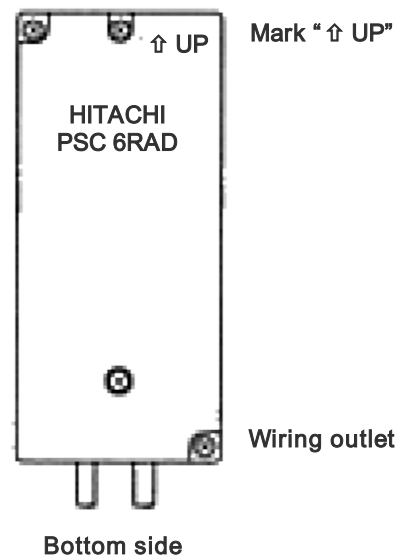

- 3) Installation procedure
 - a) When installing to the wall.
 - i) Fix the adaptor with 2 screws. Tapping screw is for metal surface, and other screw is for wooden surface.

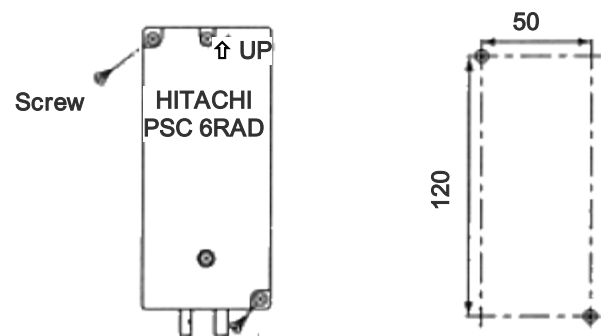

- ii) When using the cover

It can be installed at the right and left side of room air conditioner. Fix the cover and RAC adaptor with the two-sided tape (accessory).

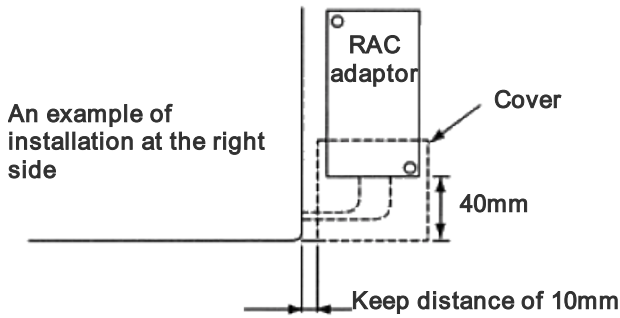

- b) When installing on the room air-conditioner
- In case that it cannot be installed to the wall due to the space or material problem, install the RAC adaptor with the two-sided tape (accessory) on the room air-conditioner.
- i) Confirm if the piping cover of the unit can be removed when performing the service maintenance, and then fix the RAC adaptor in the side of room air-conditioner with two-sided tape. (Available at the right as well as left side)
 - ii) Clean the surface to be installed with a dry cloth.

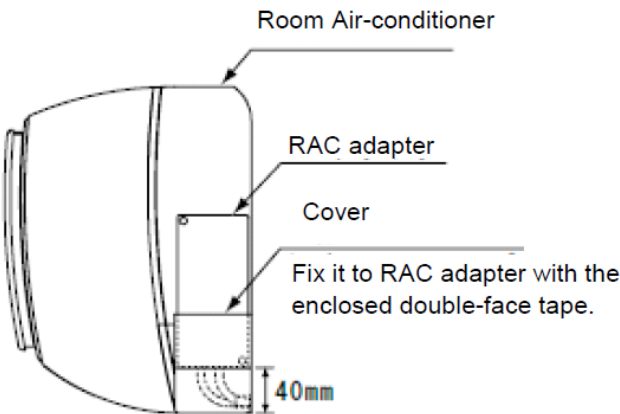

NOTE:

- Consider the following points since the adhesiveness changes according to the environmental conditions (temperature, humidity etc)
- The adhesiveness is decreased when there is humidity or oil.
- Warm the adhesive part and installation place of the two-sided tape to avoid the decrease of the adhesiveness in case the ambient temperature is low.
- DO NOT touch the adhesive part by fingers nor re-attach it many times. The adhesiveness has decreased and the RAC adaptor may fall off.
- DO NOT apply any force within 24 hours after installation.

10.2.3. ELECTRICAL WIRING

■ System configuration

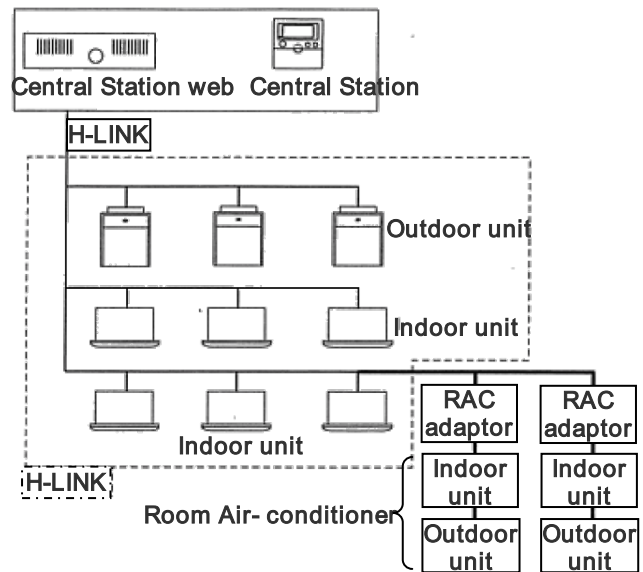

CAUTION:

- Turn OFF the power supply of the room air-conditioner of the central control device when performing the wiring work
- DO NOT run all the H-LINK cable or power supply cable along the other signal cable, or malfunction may occur due to the noise, etc. If it is required to run along the other transmission cable, separate the cable more than 30cm, or run the cable through the metal tube and earth the tube.
- Follow local codes and regulations when performing electrical wiring and earth wiring.
- Transmissions cable used in H-LINK shall be 2 cores cable (0.7mm² to 1.25mm² for model: VCTF, VCT, CVV, MVVX, CVVX, VVR, VVF) or 2 cores twisted pair cable (model: KPEV, KPEV-Spec). Total length of cable shall be below 1000mm.
- DO NOT use wire with more than 3 cores.

■ Internal components and Wiring connections

Check the contents and the number of the accessories in the packing.

- Access
Open the cover by removing the ① and ② screws.



- Wiring Connection
Connection with Room Air-Conditioner
 - i) Remove the front cover of the room air-conditioner and the cover of electrical box.
 - ii) The cable attached with the connector of the RAC adaptor shall be connected with the connector of indoor PCB

- iii) Install the electrical box cover paying attention not to clamp the cable. Read the installation manual of each room air-conditioner for confirming how to connect and how to assemble the cable of the RAC adaptor.

CAUTION:

- Disconnect the power plug before performing this work
- Turn OFF the break power source in case the power is supplied from the outdoor unit.

• Connection of Transmission Cable
H-LINK transmission cable connecting to RAC adaptor shall be connected to H-LINK.

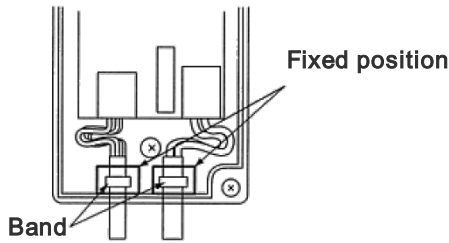
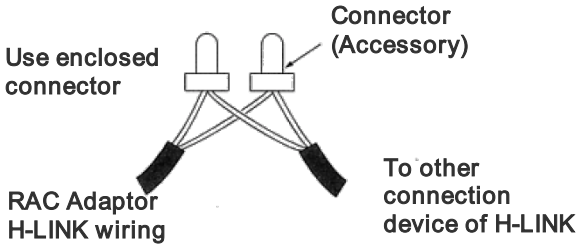

CAUTION:

- DO NOT connect incorrect wiring. It may cause the failure of the RAC Adaptor. Especially pay attention not to apply high voltage e.g. AC400/230V.
- DO NOT perform the wiring work while power to the central station or the RAC Adaptor is still being supplied. It may cause malfunction. Turn OFF devices when performing the wiring work.
- The RAC Adaptor side cable should not overload to the connector.
- DO NOT clamp the cable when attaching the RAC adaptor cover.
- Band should not be loose and in fixed position.

10.2.4. DIP SWITCH SETTING

- 1) Switch OFF the power of room air conditioner before setting the DIP switch. If the power is ON, the settings are INVALID.
- 2) The position of the DIP switch is shown below.

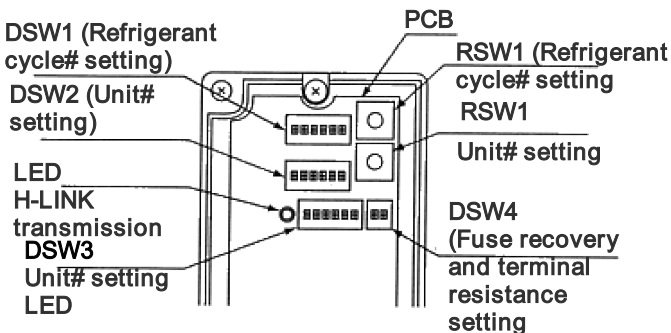

CAUTION:

- DO NOT turn ON various pins of DSW1 and DSW2

- 3) Set the refrigerant cycle# by RSW1 and DSW1

DSW1 (Ten digit)	RSW1 (Last digit)
DSW1 and RSW1 are set "0" before shipment. Up to 15 cycles can be set. E.g. Setting in Ref No. 5	
No. 1 pin is OFF	The position is Set 5

- 4) Set the unit No. by RSW2 and DSW2

DSW2 (Ten digit)	RSW2 (Last digit)
DSW2 and RSW3 are set "0" before shipment. Up to 15 cycles can be set. E.g. Setting in Unit No. 15	
No. 1 pin is OFF	The position is Set 5

- 5) Slave unit.

In case of setting various RAC adaptors in the same refrigerant cycle, set the RAC adaptor with smallest Unit# as a master unit. In case of setting only one RAC adaptor in a refrigerant system, this adaptor should be a master unit. Set this procedure by DSW3.

Master Unit setting	Setting before shipping (slave unit setting)

●: Master Unit setting

○: Setting before Shipping (Slave Unit setting)

		Indoor Unit#							
		0	1	2	3	4	5	6	7
Refrigerant Unit#	0	●	○	○	○	○			
	1			●	○	○			
	2				●	○	○	○	○
	3		●						
	4								

CAUTION:

– DO NOT set various main adaptors in the same refrigerant cycle.

- 6) Procedure when applying 200V voltage to H-LINK wiring incorrectly.

In case of applying 200V voltage to H-LINK wiring incorrectly, the fuse installed in a transmission circuit on PCB will blow out. In this case, reconnect the wiring correctly and turn ON No. 2 pin of DSW4 on PCB. The transmission circuit can be recovered. (If applying this error again, the transmission circuit can not be recovered)



Turn ON No.2 pin of DSW4

- 7) Terminating resistance is set in whole H-LINK system.
 - a) If H-LINK connecting devices like package air-conditioner are connected besides the RAC Adaptor, set the terminating resistance by those connecting devices. The terminating resistance should be set ON in only one position in whole H-LINK system.
 - b) In case that H-LINK is connected only by the RAC adaptor, set the terminating resistance by the RAC adaptor. The terminating resistance should be set ON in only one position in whole H-LINK system.

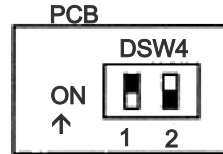

Turn ON No.1 pin of DSW4

10.2.5. TEST RUN

Test run should be performed in the following after finishing the installation, wiring and setting. Refer to the installation manuals enclosed with the control system equipment.

- 1) Confirmation of RAC Adaptor Connection

Confirm if the RAC adaptor connection is recognized in the control system equipments. In case that it is not confirmed, check the transmission cable, refrigerant cycle #, indoor unit #, terminal resistance setting etc.
- 2) Registration

Confirm if the RAC adaptor connection is recognized.
- 3) Confirmation of RUN/STOP Operation.

Confirm if the room air-conditioner operate correctly by RUN/STOP from the central control system equipments. Check also if the room air-conditioner operation changes correctly by each setting.

10.3. DRY CONTACT (SPX-WDC3) APPLICATION

The dry contact system enables the operation of the air conditioner indoor unit to be controlled by using external dry contacts (with non voltage) such as card-key controller or window for facilities such as hotels.

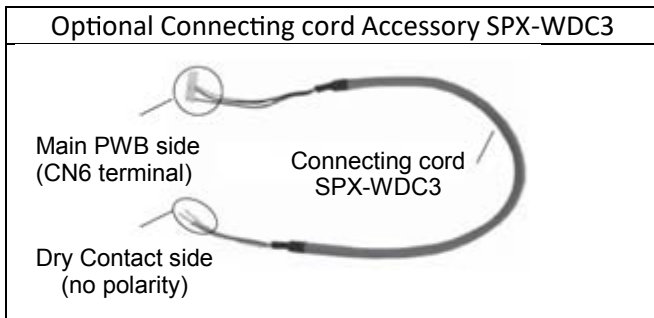

- Please decide A or B type of dry contact , you can use HHRC method and more details you can refer to Page 19.

Function Name	Value	Layer1	Layer2	Layer3
		Category	Function	Value
CardKey	Disable	1A	A0	01
	Card Key Input -A Enable			02
	Card Key Input -B Enable			03
	reserve			04-99

[1] CHECK DRY CONTACT OF CARD KEY UNIT

	AIR CONDITIONER Standby	AIR CONDITIONER Operating
	CARD KEY (Door Switch)	REMOVE
Contact type A	OPEN 	CLOSE
Contact type B	CLOSE 	OPEN

After all connection has been done as below diagram, ON the breaker and push ON button of wireless remote controller or wired remote controller to operate the air conditioner unit.

- When the CARD KEY is in insert condition, the air conditioner operation is allowable by remote controller.
- When the dry contact switch on the Card Key Unit is open (refer to diagram below for contact type a), the unit stops to operate (it takes 10 seconds to stop the unit operation after the dry contact switch on the card key turns off) and vice versa.
- When the card key is removed from the Card Key Unit, the wireless remote controller cannot be used.
- When the card key is removed from the Card Key Unit, the wired remote controller LCD display is activated; however it has no control over the unit.
- The suitable accessory Connecting Cord (accessory code#: SPX-WDC3) need to be used to connect the Card Key Unit's dry contact switch to the connector on the control board of the indoor unit. Please refer to Table 1 to select suitable accessory code# for the concerning indoor model.

Example of wiring connection to Card Key Unit will be as below (reference only)

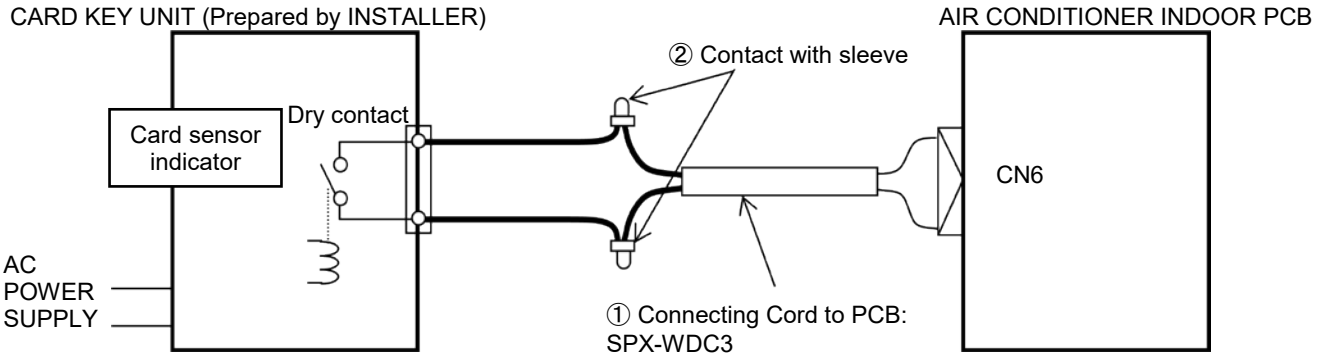

• CONNECTION EXAMPLE

i. HHRC for Dry Contact Type A

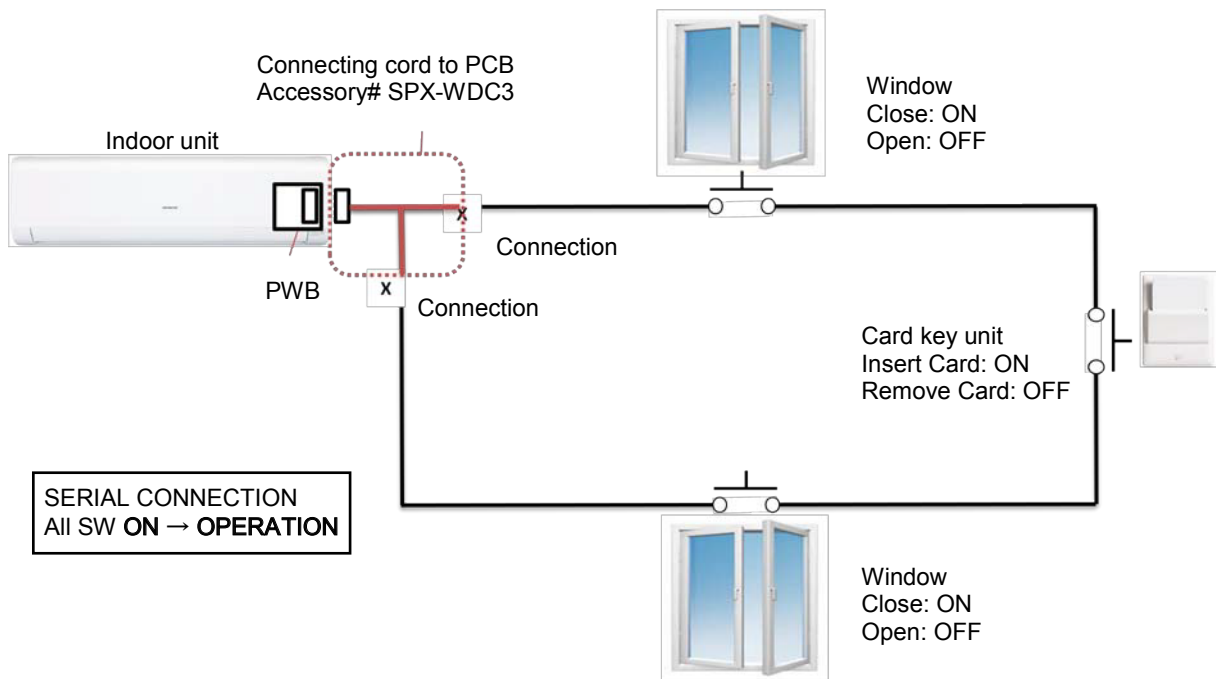

ii. HHRC for Dry Contact Type B

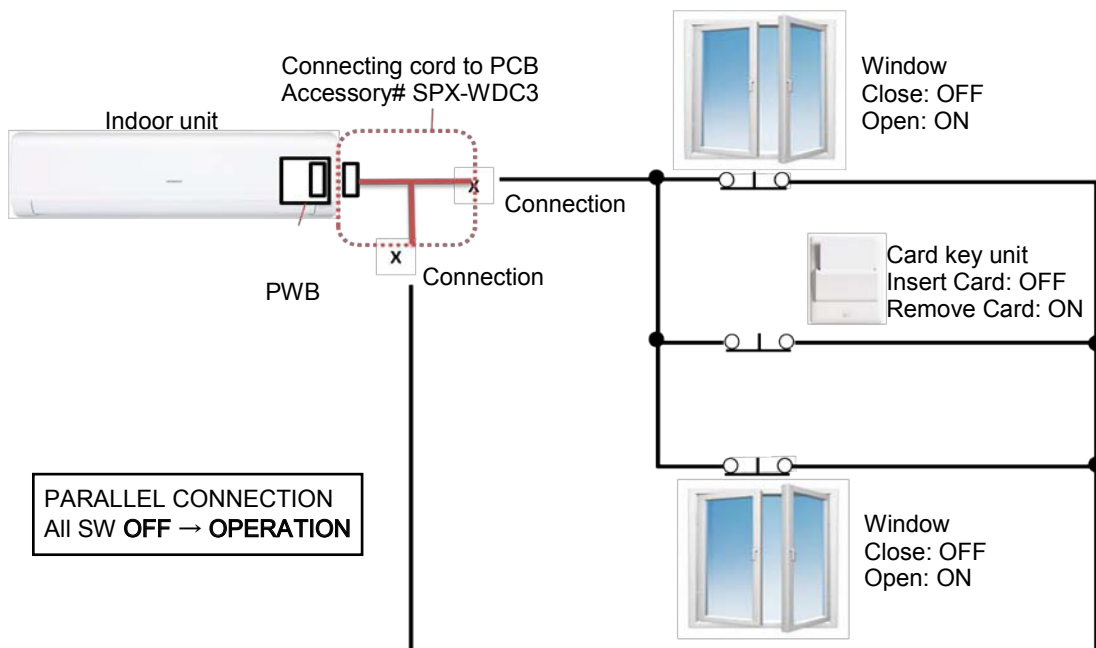

Please refer to the actual manual supplied with the optional connecting cords SPX-WDC3 for more details.

HITACHI

INDOOR

RAK-VJ25PHAT

RAK-VJ35PHAT

OUTDOOR

RAC-VJ25PHAT

RAC-VJ35PHAT