

OPA 294RKTB

Packaged Reverse Cycle R410A Air Cooled Air Conditioner

Installation & Maintenance

GENERAL

This OPA 294RKTB unit must be installed in accordance with all national and local safety codes.

CONFIGURATIONS

The OPA 294RKTB is supplied in one of two standard configurations :

1. Horizontal supply/return air with box mounting channel (RKTBH), or
2. Downward supply air with box mounting channel (RKTBU).

REFRIGERATION SYSTEM

General

The OPA 294 has two independent refrigeration circuits and two compressors to provide the flexibility and economy of two stage operation, i.e. utilising one or two circuits as conditions vary, plus the advantage of staggered starting.

The refrigeration system has been charged with HFC-410A (R410A) refrigerant; refer wiring diagram specification table for amount. Tapping points are provided to measure discharge and suction operating pressures.

Compressors

The compressor is directional scroll type. The compressor lubricant is polyol ester oil (POE). Note, this oil absorbs moisture quickly if exposed to open air. On commissioning, the compressor must be checked for correct rotation (refer Start Up Procedure).

ECONOMISER (Option)

If the outdoor air heat content or temperature is below that of the return air, the fresh air damper opens and the return air damper closes to provide the first stage of cooling. The compressor will then operate to provide more cooling if required.

INSTALLATION

Unpacking

Units configured with Downward supply air and mounting rails, have their spigots shipped loose inside the return air cavity.

Positioning

Refer to dimension diagrams for minimum clearances. If multiple units are to be placed side-by-side then allow at least 2 m between coil faces.

Mounting

The unit should be fastened to a firm flat horizontal base using the holes supplied in the box mounting channel.

When the unit is being installed on a roof it is recommended that the unit is installed on a substantial structure with anti-vibration mounts or pads.

Flexible duct connections are recommended between the supply and return ducts and the unit.

Condensate Drain

The condensate drain should be 'U' trapped outside the unit. The trap should have a Downward height of at least 100 mm. The drain should have a slope of at least 1 in 50 and must not be piped to a level above the unit drain pipe (see figure 3).

Electrical Requirements

Electrical work must be done by a qualified electrician. The outdoor unit must be wired directly from a distribution board by means of a circuit breaker or H.R.C. fuse, and a mains isolator provided - preferably close to the unit.

Note: DO NOT USE REWIRABLE FUSES.

The OPA 294 is provided with a 24V AC control circuit for a thermostat, on/off switch and/or time clock.

The control transformer 240V primary voltage is used for countries with 230-240V power supply. For countries with supply voltages 200-220V, change the primary voltage on the transformer to 208V.

Standard units are suitable for use with thermostats with either manual Heat/Cool selection or automatic changeover subject to the contact ratings of the thermostats.

CHECK TESTS

1. Leave the remote switch in the off position and close the mains isolating switch. A four hour delay period is required to allow the crankcase heater to drive any liquid refrigerant out of the compressor oil. Bypass the crankcase heater thermostat (CCHT) for this period only.
2. Check that the shipping block beneath the compressors have been removed and that the compressors are secure on their mounts.
3. Check that all fan motors are free running.
4. Check that the thermostat is correctly wired to the unit and is set at the desired temperature.
5. Check that the air filters have been correctly installed if fitted.
6. Check air diffuser dampers are open if appropriate.

START UP PROCEDURE

Use the supplied Commissioning Sheet to help you complete the following procedure:

1. Switch on the unit after the four hour delay period for the crankcase heater has expired. Ensure the crankcase heater thermostat has been reconnected.
2. The compressor fitted is directional. Check for correct rotation. If rotation is incorrect the compressor will not pump, be noisy, and will draw minimal current. To correct motor rotation, change the phasing at the main power terminal. If changing the phasing, check the indoor air fan then runs in the correct direction also.
3. Check the supply voltage between each phase and neutral.
4. Measure the current draw on each phase to the compressor motor and measure the current draw of each fan motor. Check all readings against the specified values in the wiring diagram.
5. Fit gauges and measure the suction and discharge pressures of both refrigeration circuits.
6. Check that the outdoor air fan motors are running smoothly.
7. Test the operation of the reversing valve by running the unit in both the heating and cooling mode.
8. Check the indoor unit's fan belt tension after 20 mins of operation and adjust if necessary (refer Commissioning Sheet).
9. Check the supply air flow at each outlet.
10. Check the tightness of all electrical connections and sign the check label.
11. Touch up any outdoor unit paintwork damage to prevent corrosion.

SETTING SUPPLY AIR FLOW

Consult OPA 294 Technical Data pamphlet for details of airflow/duct static pressure, if required.

If the indoor air returning to the unit is regularly expected to be above 50%RH, then the coil face velocity should be limited to be 2.5 m/s or less (refer Air Handling graph in Technical Data pamphlet).

High humidity levels can occur in tropical or subtropical conditions, and/or when heavily moisture laden fresh air is introduced. Select a fan speed that avoids water carry-over problems.

In a free blow or low resistance application, beware of exceeding the fan motor's full load amp limit (refer wiring diagram).

The indoor air fan motor is fitted with a factory set adjustable pitch pulley.

Instructions for the adjustment of pulleys is included on the back page of the supplied Commissioning Sheet. One revolution of adjustment is equal to approx. 7% change in air volume flow rate.

OUTDOOR UNIT CONTROLLER (OUC)

The Outdoor Unit Controller (OUC) includes a temperature sensing head pressure control which enables the system to compensate for outdoor ambient temperatures below 20°C on cooling cycle, and above 15°C on heating cycle. The OUC also has features which protect against icing or overheating of coils, rapid cycling of the compressor and loss of refrigerant charge.

If the outdoor air fans take some time to begin rotating when the system is powered on, or they don't appear to be rotating appropriately while the compressor is running, consult the OUC label on the electrical box. If necessary, refer to **temperzone** for further diagnostic information.

MAINTENANCE

Monthly

1. Check air filters, if fitted, and vacuum or wash clean as necessary.
2. Check condensate drain for free drainage.
3. Check compressor compartment for oil stains indicating refrigerant leaks.

Three Monthly (or every 1200 hrs of operation)

Check the indoor unit's fan belt tension and adjust if necessary.

Six Monthly

1. Check the tightness of electrical connections.
2. Check the tightness of fans, motor mountings, pulleys and belt tension.
3. Check suction and discharge operating pressures.
4. Replace indoor air filters (if fitted).
5. Check condensate drain for free drainage.

Yearly

1. Check all refrigerant piping for chafing and vibration.
2. Check the operation of electric heaters, if fitted.
3. Check air supply at all diffusers.
4. Check for excessive noise and vibration and correct as necessary.
5. Check for insulation and duct damage and repair as necessary.
6. Check and remove as necessary any lint and dust accumulation from outdoor coil fins. In corrosive environments, the checking and cleaning frequency should be increased.
7. Touch up any paintwork damage to prevent corrosion.

NOTE

The manufacturer reserves the right to make changes in specifications at any time without notice or obligation. Certified data is available on request.

This pamphlet replaces the previous issue no. 3865 dated 03/18. Wiring revision E.

DIMENSIONS (mm)

OPA 294RKT B

Fig. 1 OPA 294RKT B H – Horizontal Supply & Return Air

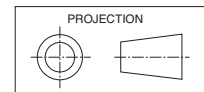
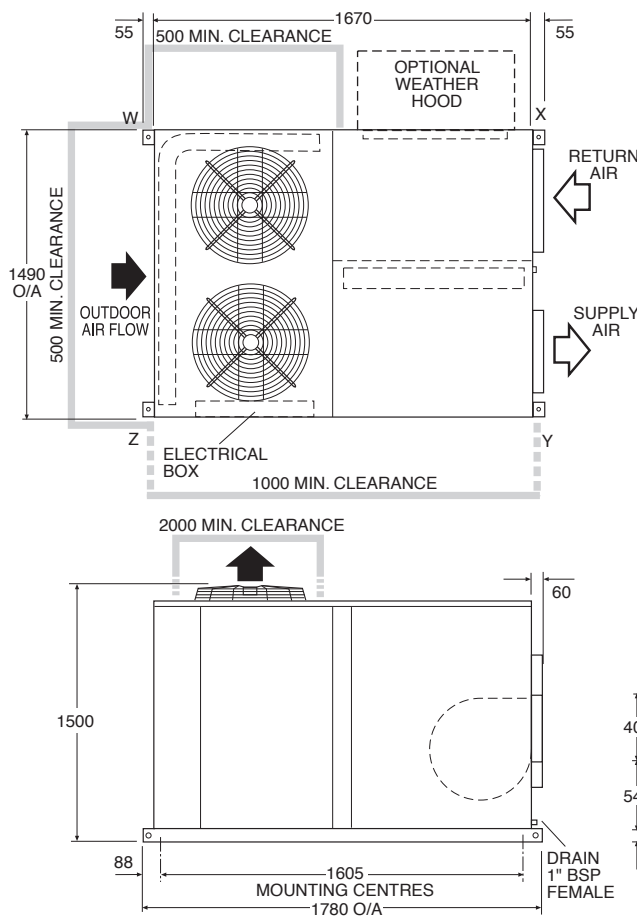

Not to Scale

POINT LOADS (kg)			
W	X	Y	Z
109	131	129	191

Net Weight 560 kg

Note : A 2 m clearance is required above the exhaust air fans

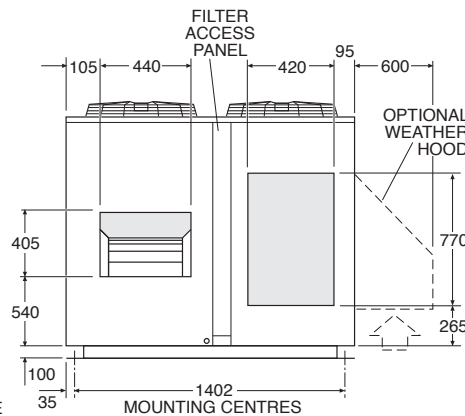

DIMENSIONS (mm)

OPA 294RKTB

Fig. 2 OPA 294RKTBU – Downward Supply & Return Air

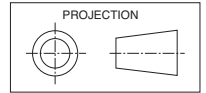

Not to Scale

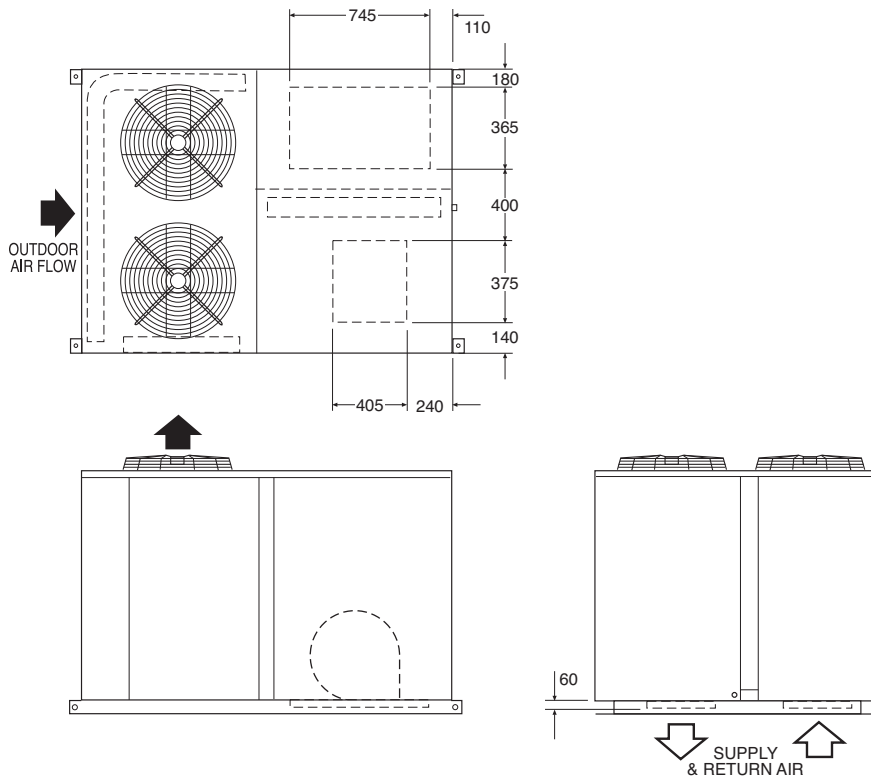

Note:
Supply and return air spigots are shipped loose inside the return air cavity.

Fig. 3 Condensate Drain

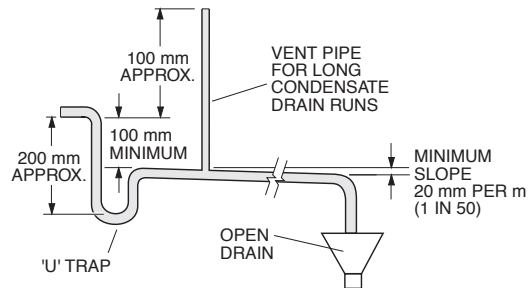

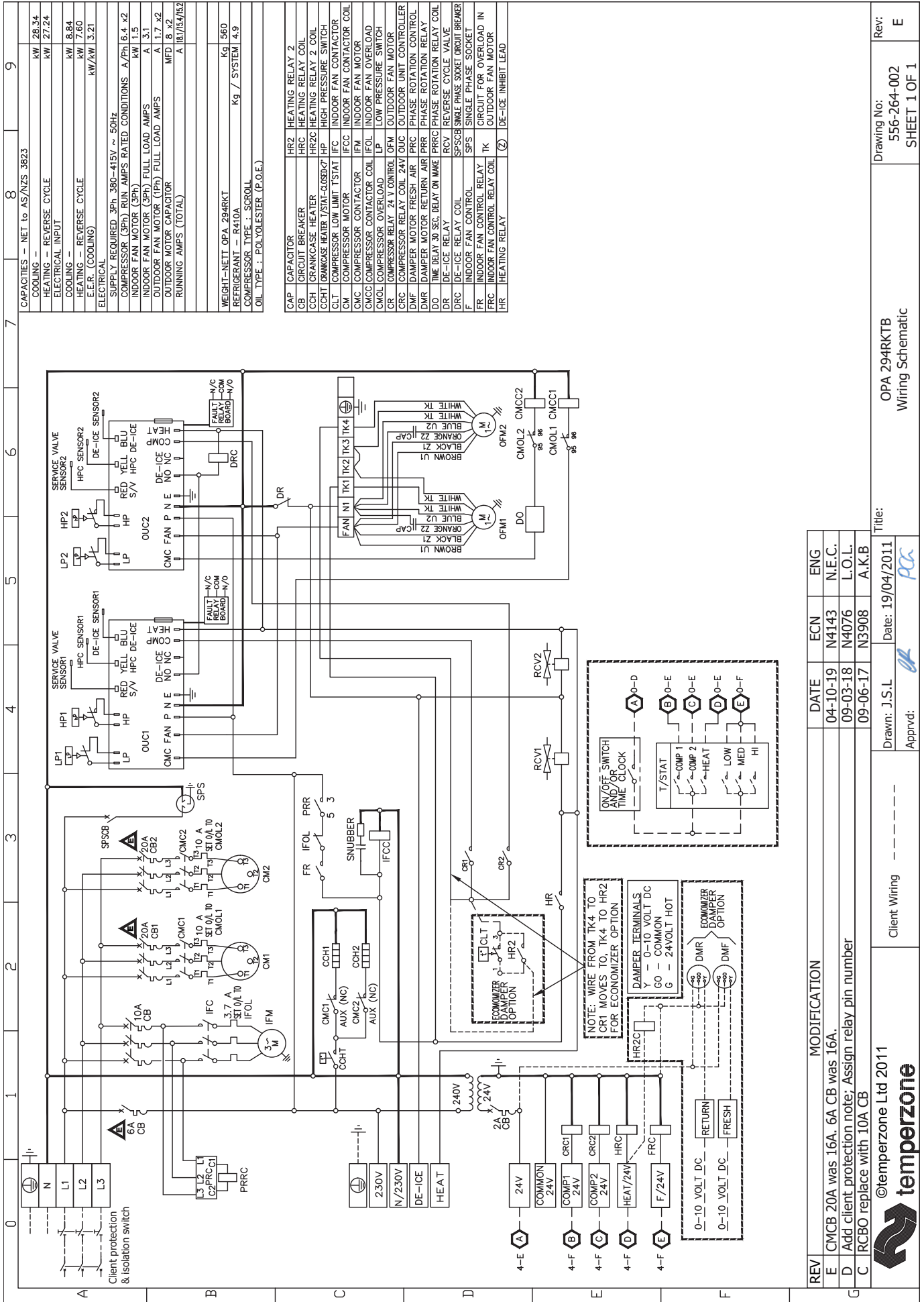

REV	MODIFICATION	DATE	ECN	ENG
E	CMCB 20A was 16A. 6A CB was 16A.	04-10-19	N4143	N.E.C.
D	Add client protection note; Assign relay pin number	09-03-18	N4076	L.O.L.
C	RCBO replace with 10A CB	09-06-17	N3908	A.K.B

Client Wiring

Drawn: J.S.L. Date: 19/04/2011

Approved: *[Signature]*

©temperzone Ltd 2011

temperzone

OPA 294RKT B
Wiring Schematic

Drawing No: 556-264-002
SHEET 1 OF 1

Rev: E