

HITACHI

HEAT PUMPS

RAS-35YHA(/RAC-35YHA(

USER MANUAL

(Extract from Service Manual)





SAFETY PRECAUTION

- Please read the "Safety Precaution" carefully before operating the unit to ensure correct usage of the unit.
- Pay special attention to signs of "▲ Warning" and "▲ Caution". The "Warning" section contains matters which, if not observed strictly, may cause death or serious injury. The "Caution" section contains matters which may result in serious consequences if not observed properly. Please observe all instructions strictly to ensure safety.
- The signs indicate the following meanings. (The following are examples of signs.)





 This sign in the figure indicates prohibition.  Indicates the instructions that must be followed.

- Please keep this manual after reading.

















PRECAUTIONS DURING INSTALLATION

WARNING	<ul style="list-style-type: none"> • Do not reconstruct the unit. Water leakage, fault, short circuit or fire may occur if you reconstruct the unit by yourself. 
	<ul style="list-style-type: none"> • Please ask your sales agent or qualified technician for the installation of your unit. Water leakage, short circuit or fire may occur if you install the unit by yourself.
	<ul style="list-style-type: none"> • Please use earth line. Do not place the earth line near water or gas pipes, lightning-conductor, or the earth line of telephone. Improper installation of earth line may cause electric shock. 
	<ul style="list-style-type: none"> • Be sure to use the specified piping set for R410A. Otherwise, this may result in broken copper pipes or faults.
CAUTION	<ul style="list-style-type: none"> • A circuit breaker should be installed depending on the mounting site of the unit. Without a circuit breaker, the danger of electric shock exists. • Do not install the unit near a location where there is flammable gas. The outdoor unit may catch fire if flammable gas leaks around it. Piping shall be suitable supported with a maximum spacing of 1m between the supports. 
	<ul style="list-style-type: none"> • Please ensure smooth flow of water when installing the drain hose. If any failure is found in the drain path, water drops from the indoor and outdoor units, causing wet household effects.
	<ul style="list-style-type: none"> • Make sure that a single phase 240V power source is used. The use of other power sources may cause electrical components to overheat and lead to fire. 

PRECAUTIONS DURING SHIFTING OR MAINTENANCE

WARNING	<ul style="list-style-type: none"> • Should abnormal situation arise (like burning smell), please stop operating the unit and remove plug from the socket or turn off the circuit breaker. Contact your agent. Fault, short circuit or fire may occur if you continue to operate the unit under abnormal situation. 
	<ul style="list-style-type: none"> • Please contact your agent for maintenance. Improper self maintenance may cause electric shock and fire.
	<ul style="list-style-type: none"> • Please contact your agent if you need to remove and reinstall the unit. Electric shock or fire may occur if you remove and reinstall the unit yourself improperly.
	<ul style="list-style-type: none"> • Avoid an extended period of direct air flow for your health. 
	<ul style="list-style-type: none"> • Do not connect the power cable with an extension cable or do not plug too many leads of the other electric appliance into the socket where this cable is plugged. In addition, wire the cable with some allowances to prevent the cable from stretching. Not doing so will cause an electrical shock, heat generation or fire. 
	<ul style="list-style-type: none"> • Do not bundle the power cable, pull it, put something on it, heat it, process it, or put it between things. Breakage of the power cable may result. Use of a damaged cable may cause an electrical shock or a fire. 
<ul style="list-style-type: none"> • Do not put objects like thin rods into the panel of blower and suction side because the high-speed fan inside may cause danger.  	

PRECAUTIONS DURING OPERATION

WARNING	<ul style="list-style-type: none"> • Do not use any conductor as fuse wire, this could cause fatal accident. 
	<ul style="list-style-type: none"> • During thunder storm, disconnect the plug top or turn off the circuit breaker. 
CAUTION	<ul style="list-style-type: none"> • Spray cans and other combustibles should not be located within a meter of the air outlets of both indoor and outdoor units. As a spray can's internal pressure can be increased by hot air, a rupture may result. 
	<ul style="list-style-type: none"> • The product shall be operated under the manufacturer specification and not for any other intended use. 
	<ul style="list-style-type: none"> • Do not attempt to operate the unit with wet hands, this could cause fatal accident. 
	<ul style="list-style-type: none"> • When operating the unit with burning equipments, regularly ventilate the room to avoid oxygen insufficiency. 
	<ul style="list-style-type: none"> • Do not direct the cool air coming out from the air-conditioner panel to face household heating apparatus as this may affect the working of apparatus such as the electric kettle, oven etc. 
	<ul style="list-style-type: none"> • Please ensure that outdoor mounting frame is always stable, firm and without defect. If not, the outdoor unit may collapse and cause danger. 
	<ul style="list-style-type: none"> • Do not wash the unit with water or place a water container such as a vase on the indoor unit. Electrical leakage could be present and cause electric shock. 
	<ul style="list-style-type: none"> • Do not place plants or animals directly under the air flow as it is bad for the plants or animals. 
	<ul style="list-style-type: none"> • Do not climb on the outdoor unit or put objects on it. 
	<ul style="list-style-type: none"> • When operating the unit with the door and windows opened, (the room humidity is always above 80%) and with the air deflector facing down or moving automatically for a long period of time, water will condense on the air deflector and drips down occasionally. This will wet your furniture. Therefore, do not operate under such condition for a long time. 
<ul style="list-style-type: none"> • If the amount of heat in the room is above the cooling or heating capability of the unit (for example: more people entering the room, using heating equipments and etc.), the preset room temperature cannot be achieved.  	
<ul style="list-style-type: none"> • This appliance especially indoor unit cleaning must be performed by authorized personnel only. Consult your sales agent. Using a commercially available detergent or similar can damage the plastic parts or clog the drain pipe, causing water to drip with potential electric shock hazard.  	
<ul style="list-style-type: none"> • Do not touch the air outlet, bottom surface and aluminum fin of the outdoor unit. You may get hurt.  	
<ul style="list-style-type: none"> • Do not touch the refrigerant pipe and connecting valve. Burns may result.  	
<ul style="list-style-type: none"> • This appliance is not intended for use by young children or infirm persons unless they have been adequately supervised by a responsible person to ensure that they can use this appliance safely. • Young children should be supervised to ensure that they do not play with the appliance. 	

NAMES AND FUNCTIONS OF EACH PART

INDOOR UNIT

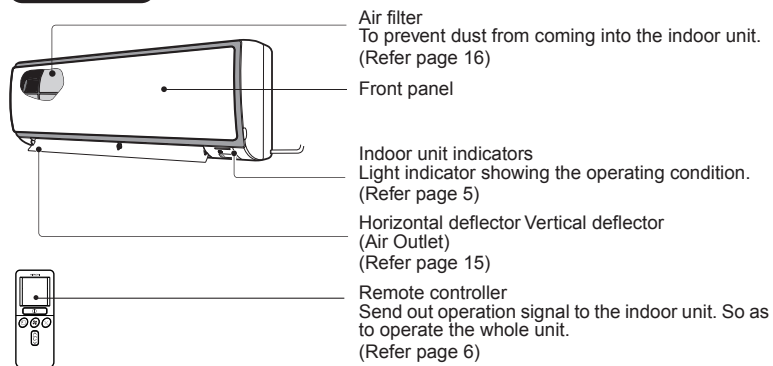

OUTDOOR UNIT

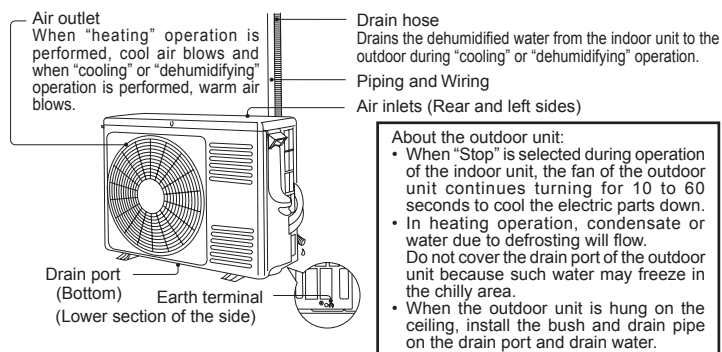

MODEL NAME AND DIMENSIONS

MODEL	WIDTH (mm)	HEIGHT (mm)	DEPTH (mm)
RAS-25YHA3/RAS-35YH4	780	280	220
RAC-25YHA3/RAC-35YH4	750	548	288

NAMES AND FUNCTIONS OF EACH PART

INDOOR UNIT INDICATIONS

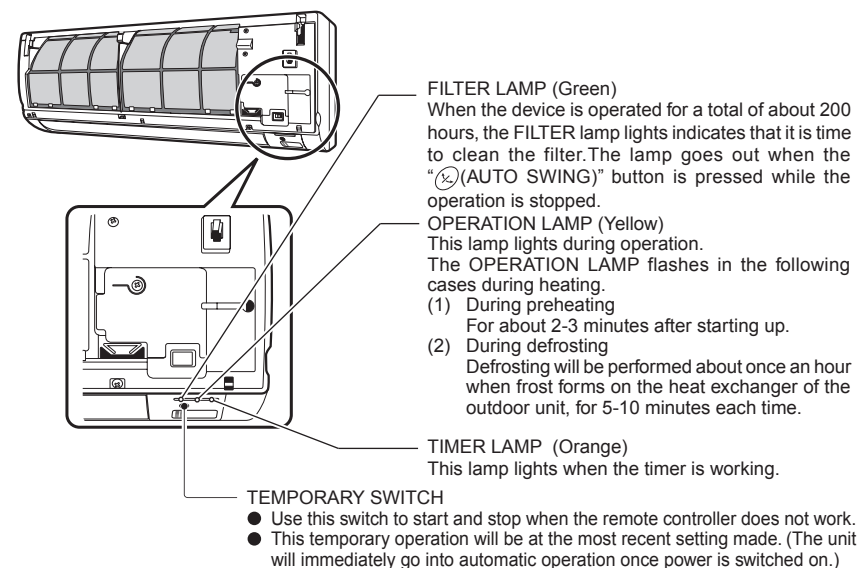

CAUTION

Turn off the circuit breaker or pull out the power plug if the unit is not be operated for a long period.

☆ If the power stays on and the unit is not operated, power is slightly consumed in the control circuit. The power is saved by turning off the power switch (or the circuit breaker when the power is supplied from the outdoor unit).

- Attaching the air purifying filters (Accessories) to the filter frame.
 - Attach the air cleansing and deodorizing filters to the frame by gently compress its both sides and release after insertion into filter frame.
 - The cooling capacity is slightly weakened and the cooling speed becomes slower when the air purifying filters are used.
 - Air purifying filters can be used for about 1 year. When you want to renew it, please ask your sales agent. Optional air cleansing and deodorizing filters (SPX-CFH15).

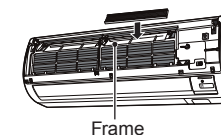

NAMES AND FUNCTIONS OF EACH PART

REMOTE CONTROLLER

- This controls the operation of the indoor unit.
The range of control is about 7 meters. If indoor lighting is controlled electronically, the range of control may be shorter, in some cases, the control signal may not be received.
This unit can be fixed on a wall using the fixture provided. Before fixing it, make sure the indoor unit can be controlled from the remote controller.
- Handle the remote controller with care.
Dropping it or getting it wet may compromise its signal transmission capability.
- After new batteries are inserted into the remote controller, the unit will initially require approximately 10 seconds to respond to commands and operate.

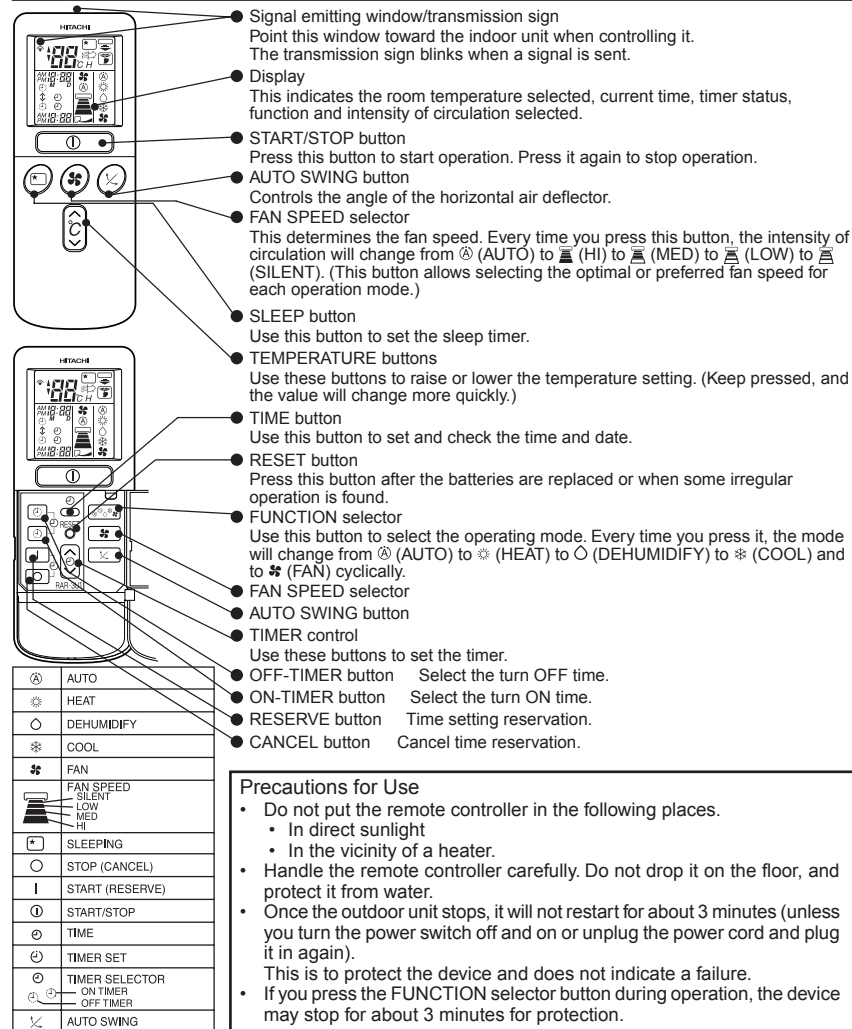

VARIOUS FUNCTIONS

Auto Restart Control

- If there is a power failure, operation will be automatically restarted when the power is resumed with previous operation mode and airflow direction.
(As the operation is not stopped by remote controller.)
- If you intend not to continue the operation when the power is resumed, switch off the power supply. When you switch on the circuit breaker, the operation will be automatically restarted with previous operation mode and airflow direction.
Note: 1. If you do not require Auto Restart Control, please consult your sales agent.
2. Auto Restart Control is not available when Timer or Sleep Timer mode is set.

AUTOMATIC OPERATION

The device will automatically determine the mode of operation, HEAT or COOL depending on the initial room temperature. The selected mode of operation will change when the room temperature varies.

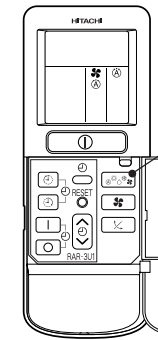

Press the FUNCTION selector so that the display indicates the (AUTO) mode of operation.

- When AUTO has been selected, the device will automatically determine the mode of operation, HEAT or COOL depending on the current room temperature.
- When AUTO is first selected, the device will determine the current room temperature and select the proper operation mode accordingly.
- When the air conditioner has adjusted the room's temperature to the near preset temperature, it will begin to monitor operation. If the room temperature subsequently changes, the air conditioner will once again select the appropriate operation (heating or cooling) to adjust the temperature to the preset temperature. The monitoring operation range is $\pm 3^{\circ}\text{C}$ relative to the preset temperature.
- If the mode automatically selected by the unit is not satisfactory, manually change the mode setting (heat, dehumidify, cool or fan).

START/STOP

Press the (START/STOP) button.
Operation starts with a beep.
Press the button again to stop operation.

- As the settings are stored in memory in the remote controller, you only have to press the (START/STOP) button next time.

You can raise or lower the temperature setting as necessary by maximum of 3°C .



Press the temperature button and the temperature setting will change by 1°C each time.

- The preset temperature and the actual room temperature may vary somewhat depending on conditions.

Press the (FAN SPEED) button to select AUTO, LOW and SILENT.

HEATING OPERATION

- Use the device for heating when the outdoor temperature is under 21°C. When it is too warm (over 21°C), the heating function may not work in order to protect the device.
- In order to keep reliability of the device, please use this device above -15°C of the outdoor temperature.

1 Press the FUNCTION selector so that the display indicates (HEAT).

Set the desired FAN SPEED with the (FAN SPEED) button (the display indicates the setting).

(AUTO) : The fan speed changes automatically according to the temperature of the air which blows out.

(HI) : Economical as the room will become warm quickly. But you may feel a chill at the beginning.

(MED) : Quiet.

(LOW) : More quiet.

(SILENT): Silent.

2 Set the desired room temperature with the TEMPERATURE buttons (the display indicates the setting).

3 The temperature setting and the actual room temperature may vary somewhat depending on conditions.

START STOP Press the (START/STOP) button. Heating operation starts with a beep. Press the button again to stop operation.

- As the settings are stored in memory in the remote controller, you only have to press the (START/STOP) button next time.

■ Defrosting

Defrosting will be performed about once an hour when frost forms on the heat exchange of the outdoor unit, for 5~10 minutes each time.

During defrosting operation, the operation lamp blinks in cycle of 3 seconds on and 0.5 second off.

The maximum time for defrosting is 20 minutes.

(If the piping length used is longer than usual, frost will likely to form.)

DEHUMIDIFYING OPERATION

Use the device for dehumidifying when the room temperature is over 16°C. When it is under 15°C, the dehumidifying function will not work.

1 Press the FUNCTION selector so that the display indicates (DEHUMIDIFY). Press the (FAN SPEED) button to select LOW and SILENT.

START STOP Press the (START/STOP) button.

- When you want to change the operation mode, please use the FUNCTION selector.
- Set the desired temperature is available.
- You also can use the FUNCTION selector to select this operation.

■ Dehumidifying Function

- Dehumidifying takes place with a target temperature which is slightly lower than the room temperature setting. (However, target temperature is 16°C for a temperature setting of 16°C.) If the room temperature becomes lower than the target value, operation stops. If the room temperature becomes higher than the target value, operation restarts.
- The preset room temperature may not be reached depending on the number of people present in the room conditions.

COOLING OPERATION

Use the device for cooling when the outdoor temperature is -10 to 42°C.
If humidity is very high (over 80%) indoors, some dew may form on the air outlet grille of the indoor unit.

1 Press the FUNCTION selector so that the display indicates * (COOL).

Set the desired FAN SPEED with the * (FAN SPEED) button (the display indicates the setting).

2

- ⊖ (AUTO) : The FAN SPEED is HI at first and varies to MED automatically when the preset temperature has been reached.
- ☰ (HI) : Economical as the room will become cool quickly.
- ☱ (MED) : Quiet.
- ☲ (LOW) : More quiet.
- ☳ (SILENT): Silent.

Set the desired room temperature with the TEMPERATURE buttons (the display indicates the setting).

3

The temperature setting and the actual room temperature may vary somewhat depending on conditions.

Press the ⏻ (START/STOP) button. Cooling operation starts with a beep. Press the button again to stop operation. The cooling function does not start if the temperature setting is higher than the current room temperature (even though the ⏻ (OPERATION) lamp lights). The cooling function will start as soon as you set the temperature below the current room temperature.

START/STOP

■ As the settings are stored in memory in the remote controller, you only have to press the ⏻ (START/STOP) button next time.

FAN OPERATION

You can use the device simply as an air circulator. Use this function to dry the interior of the indoor unit at the end of summer.

1 Press the FUNCTION selector so that the display indicates * (FAN).

Press the * (FAN SPEED) button.

2

- ☰ (HI) : The strongest air blow.
- ☱ (MED) : Quiet.
- ☲ (LOW) : More quiet.
- ☳ (SILENT): Silent.

START/STOP

Press the ⏻ (START/STOP) button. Fan operation starts with a beep. Press the button again to stop operation.

FAN SPEED (AUTO) ... When the AUTO fan speed mode is set in the cooling/heating operation:

For the heating operation	<ul style="list-style-type: none"> • The fan speed will automatically change according to the temperature of discharged air. • As room temperature reaches the preset temperature, a very light breeze will blow.
For the cooling operation	<ul style="list-style-type: none"> • Operation starts in the "HI" mode to reach the preset temperature. • As room temperature approaches the preset temperature, fan speed automatically switches to "LOW".

HOW TO SET THE TIMER

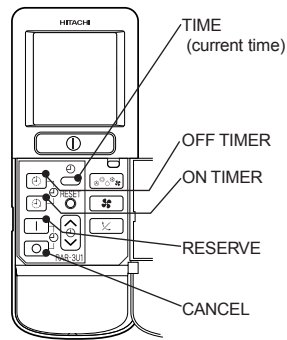

Time

Set the current time.

- After you change the batteries, the ☉ (TIME) mark will be displayed in the blinking way.

- 1 Press the ☉ (TIME) button. The ☉ (TIME) mark blinks on the display.



OFF-Timer



You can set the device to turn off at the present time.

- 1 Press the ☉ (OFF-TIMER) button. The ☉ (OFF) mark blinks on the display.

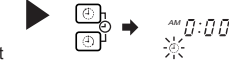

ON-Timer

The device will turn on at the designated times.

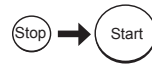

- 1 Press the ☉ (ON-TIMER) button. The ☉ (ON) mark blinks on the display.

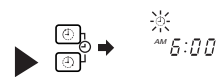

ON/OFF-Timer

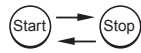

- The device will turn on (off) and off (on) at the designated times.
- The switching occurs first at the preset time that comes earlier.
- The arrow mark appearing on the display indicates the sequence of switching operations.

- 1 Press the ☉ (OFF-TIMER) button so that the ☉ (OFF) mark blinks.
 - 2 Set the turn-off time with the TIMER control button. Press the ▮ (RESERVE) button.
 - 3 Press the ☉ (ON-TIMER) button so that the ☉ (OFF) mark lights and the ☉ (ON) mark blinks.
-

- 2 Set the current time with the TIMER control button.



Example: The current time is 1:30p.m.

- 3 Press the ☉ (TIME) button again. The time indication starts lighting instead of flashing.



- The time indication will disappear automatically in 10 seconds.
- To check the current time setting, press the ☉ (TIME) button twice. The setting of the current time is now complete.

- 2 Set the turn-off time with the TIMER control button.



- 3 Point the signal window of the remote controller toward the indoor unit, and press the ▮ (RESERVE) button. The ☉ (OFF) mark starts lighting instead of flashing and the ☉ (RESERVED) sign lights. A beep occurs and the ☉ (TIMER) lamp lights on the indoor unit.

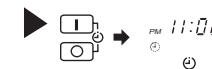

Example: The device will turn off at 11:00p.m. The setting of turn-off time is now complete.

- 2 Set the turn-on time with the TIMER control button.



- 3 Point the signal window of the remote controller toward the indoor unit, and press the ▮ (RESERVE) button. The ☉ (ON) mark starts lighting instead of flashing and the ☉ (RESERVED) sign lights. A beep occurs and the ☉ (TIMER) lamp lights on the indoor unit.

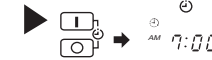

Example: The device will turn on early so that the preset temperature be almost reached at 7:00 a.m. The setting of the turn-on time is now complete.

- 4 Set the turn-on time with the TIMER control button.

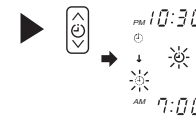

- 5 Point the signal window of the remote controller toward the indoor unit, and press the ▮ (RESERVE) button. The ☉ (ON) mark starts lighting instead of flashing and the ☉ (RESERVED) sign lights. A beep occurs and the ☉ (TIMER) lamp lights on the indoor unit.

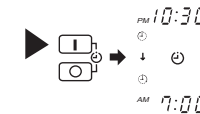

Example: For heating, the device will turn off at 10:30 p.m., and then turn on early so that the preset temperature be almost reached at 7:00 a.m.; for cooling and dehumidifying, it will simply turned on at 7:00 a.m. The settings of the turn on/off times are now complete.

How to Cancel Reservation

Point the signal window of the remote controller toward the indoor unit, and press the ○ (CANCEL) button.

The ☉ (RESERVED) sign goes out with a beep and the ☉ (TIMER) lamp turns off on the indoor unit.

NOTE

You can set only one of the OFF-timer, ON-timer and ON/OFF-timer.

- The timer may be used in three ways: off-timer, on-timer and ON/OFF (OFF/ON)-timer. Set the current time at first because it serves as a reference.

- As the time settings are stored in memory in the remote controller, you only have to press the ▮ (RESERVE) button in order to use the same settings next time.

HOW TO SET THE SLEEP TIMER

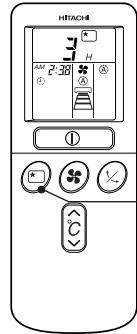

Set the current time at first if it is not set before (see the pages for setting the current time). Press the  (SLEEP) button and the display changes as shown below.

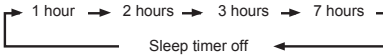

Mode	Indication
Sleep Timer	

Sleep Timer: The device will continue working for the desired number of hours and then turn off. Point the signal window of the remote controller toward the indoor unit, and press the SLEEP button. The timer information will be displayed on the remote controller. The TIMER lamp lights with a beep from the indoor unit. When the sleep timer has been set, the display indicates the turn-off time.

 Example: If you set 3 hours sleep time at 11:38 p.m., the turn-off time is 2:38 a.m.



 →  The device will be turned off by the sleep timer and turned on by on-timer.

1 Set the ON-timer.

2 Press the  (SLEEP) button and set the sleep timer.

 For heating:
 In this case, the device will turn off in 2 hours (at 1:38 a.m.) and turn on early so that the preset temperature will be almost reached at 6:00 next morning.

How to Cancel Reservation

Point the signal window of the remote controller toward the indoor unit, and press the  (CANCEL) button. The  (RESERVED) sign goes out with a beep and the  (TIMER) lamp turns off on the indoor unit.

NOTE

If you set the sleep timer when the off-time or on/off-timer has been set earlier, the sleep timer becomes effective instead of the off- or on/off-timer set earlier.

ADJUSTING THE AIR DEFLECTORS

① Adjustment of the conditioned air in the upward and downward directions. The horizontal air deflector is automatically set to the proper angle suitable for each operation. The deflector can be swung up and down continuously and also set to the desired angle using the  (AUTO SWING) button.

- If the  (AUTO SWING) button is pressed once, the horizontal air deflector swings up and down. If the button is pressed again, the deflector stops in its current position. Several seconds (about 6 seconds) may be required before the deflector starts to move.
- Use the horizontal air deflector within the adjusting range shown in the right.
- When the operation is stopped, the horizontal air deflector moves and stops at the position where the air outlet closes.

CAUTION

- In "Cooling" operation, do not keep the horizontal air deflector swinging for a long time. Some dew may form on the horizontal air deflector and dew may drop.

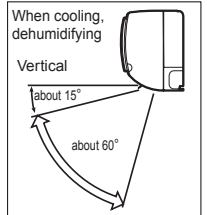
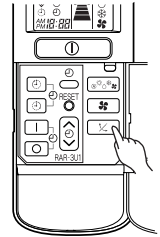

② Adjustment of the conditioned air to the left and right.

Hold the vertical air deflector as shown in the figure and adjust the conditioned air to the left and right.

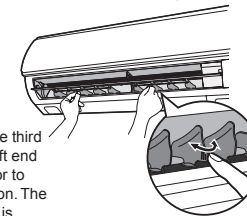

Left side: Hold the third blade from the left end of the air deflector to adjust the direction. The pull for the blade is marked.

Right side: Hold the third blade from the right end of the air deflector to adjust the direction. The pull for the blade is marked.

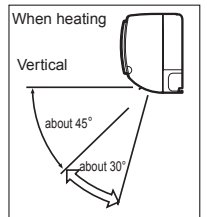

HOW TO EXCHANGE THE BATTERIES IN THE REMOTE CONTROLLER

① Remove the cover as shown in the figure and take out the old batteries.

② Install the new batteries. The direction of the batteries should match the marks in the case.

CAUTION

1. Do not use new and old batteries, or different kinds of batteries together.
2. Take out the batteries when you do not use the remote controller for 2 or 3 months.

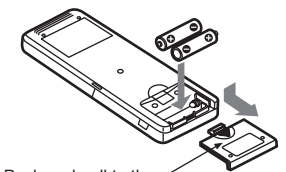

Push and pull to the direction of arrow.

MAINTENANCE

⚠ CAUTION

Cleaning and maintenance must be carried out only by qualified service personal. Before cleaning, stop operation and switch off the power supply.

1. AIR FILTER

When the filter indicator lamp comes on, be sure to clean the filter. By doing so, the power rates are saved. In case the air filter is full of dust, the air flow will decrease and the cooling capacity will be reduced. Further, noise may occur. Be sure to clean the filter following the procedure below.

PROCEDURE

- ① Open the front panel carefully and remove the filter.



- ② Vacuum dust from the air filter using vacuum cleaner. If there is too much dust, wash the filter with a detergent and rinse it thoroughly. After that, dry it in the shade.

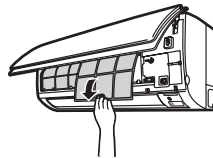

- ③
- Set the filter with "FRONT" mark facing front, and slot them into the original state.
 - After attaching the filters, push the front panel at three arrow portions as shown in figure and close it.

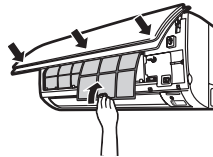

⚠ CAUTION

- Do not wash with hot water at more than 40°C. The filter may shrink.
- When washing it, shake off moisture completely and dry it in the shade; do not expose it directly to the sun. The filter may shrink.
- Don't operate the unit without filter. Fault may occur if you continue.

2. CLEANING OF FRONT PANEL

- Remove the front panel and wash with clean water. Wash it with a soft sponge. After using neutral detergent, wash thoroughly with clean water.
- When front panel is not removed, wipe it with a soft dry cloth. Wipe the remote controller thoroughly with a soft dry cloth.
- Wipe the water thoroughly. If water remains at indicators or signal receiver of indoor unit, it causes trouble.



Method of removing the front panel.
Be sure to hold the front panel with both hands to detach and attach it.

Removing the Front Panel



Attaching the Front Panel

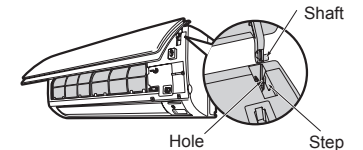

- When the front panel is fully opened with both hands, push the right arm to the inside to release it, and while closing the front panel slightly, put it out forward.
- Move the shafts of the left and right arms into the steps in the unit and securely insert them into the holes.

⚠ CAUTION

- Do not splash or direct water to the body of the unit when cleaning it as this may cause short circuit.
- Never use hot water (above 40°C), benzine, gasoline, acid, thinner or a brush, because they will damage the plastic surface and the coating.



3. MAINTENANCE AT BEGINNING OF LONG OFF PERIOD

- Run the unit by setting the operation mode to **FAN** and the fan speed to HI for about half a day on a fine day, and dry the whole of the unit.
- Switch off the power plug or turn off the circuit breaker.

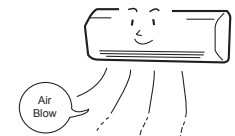

INFORMATION

CAPABILITIES

Heating Capability

- This room air conditioner utilizes a heat pump system that absorbs exterior heat and brings it into a room to be heated. As the ambient temperature gets lower, heating capability will also lower. In such a situation, the inverter work to increase compressor rpm to keep the unit's heating capability from decreasing. If the unit's heating performance is still unsatisfactory, other heating appliances should be used to augment this unit's performance.
- The air conditioner is designed to heat an entire room so that it may take some time before you feel warm. Timer operation is recommended for effective preheating ahead of the desired time.

CAUTION

Do not use a stove or any other high-temperature devices in proximity to the indoor unit.



Cooling and Dehumidifying Capabilities

- If the heat present in a room exceeds the unit's cooling capacity (for example, if there are many people in the room or other heating appliances are used), the preset room temperature may not be reached.

VARIOUS FUNCTIONS

- When fan speed, room temperature are set with the remote controller before starting manual operation and the buttons are released, the indication of settings will go off in 10 seconds and only the operation mode will be displayed.
- Pressing the button while the unit is in operation will let the protective circuit work so that the unit will not operate for approximately 3 minutes.
- During heating operation, the indoor unit's color indicator lamp may flash with no air emitted for a while.
- If you feel cold wind during heating operation with the (HI) fan speed or want to make the unit operation quieter after the room is heated, use of (AUTO) setting is recommended.
- With the (LOW), (SILENT) settings, the unit's cooling capacity will lower slightly.
- With the (LOW), (SILENT) settings, the unit's fan speed of heating operation will vary with the operating conditions.

TIMER PROGRAMMING/SLEEP TIMER OPERATION

- When the timer has been programmed, the unit will not operate even if the set time is reached unless the unit receives a signal from the remote controller. Confirm that timer programming is complete (beep) and the TIMER lamp of the indoor unit lights.
- If the (SLEEP) button is pressed while the ON/OFF timer is programmed, the sleep timer takes priority.
- During sleep timer operation, the fan speed sets to (SILENT) regardless of the preset speed. The remote controller display indication will remain unchanged even with the (SILENT) setting.

REGULAR INSPECTION

PLEASE CHECK THE FOLLOWING POINTS EVERY EITHER HALF YEARLY OR YEARLY. CONTACT YOUR SALES AGENT SHOULD YOU NEED ANY HELP.

1		WARNING	Check to see if the unit's earth line has been connected correctly. If the earth line is disconnected or faulty, unit failure or electric shock hazard may result.
2		WARNING	Check to see if the mounting frame has rusted excessively or if the outdoor unit has tilted or become unstable. It could collapse or fall, causing injury.
3		WARNING	Check to see if the power plug is securely inserted into the wall socket. If the power plug is not inserted into the wall socket securely or becomes hot, an electric shock or fire may result. If dust or dirt is found on the power plug, clean the plug and insert it into the wall socket.

AFTER SALES SERVICE AND WARRANTY

WHEN ASKING FOR SERVICE, CHECK THE FOLLOWING POINTS.

CONDITION	CHECK THE FOLLOWING POINTS
If the remote controller is not transmitting a signal. (Remote controller display is dim or blank.)	<ul style="list-style-type: none"> Do the batteries need replacement? Is the polarity of the inserted batteries correct?
When it does not operate.	<ul style="list-style-type: none"> Is the fuse all right? Is the voltage extremely high or low? Is the circuit breaker "ON"? Is the power plug inserted? Do you have any power cut?
When it does not cool well. When it does not heat well.	<ul style="list-style-type: none"> Is the air filter blocked with dust? Is the set temperature suitable? Have horizontal air deflectors been adjusted to their correct positions according to the operation mode selected? Are the air inlets or air outlets of indoor and outdoor units blocked? Is the fan speed "LOW" or "SILENT"?

■ The following phenomena do not indicate unit failure.

During heating, the operation indicator blinks and air blow stops	<Operation start> The unit is preparing to blow warm air. Please wait. <In operation> The outdoor unit is defrosting. Please wait.
Hissing or fizzy sounds	Refrigerant flow noise in the pipe or valve sound generated when flow rate is adjusted.
Squeaking noise	Noise generated when the unit expands or contracts due to temperature changes.
Rustling noise	Noise generated with the indoor unit fan's rpm changing such as operation start times.
Clicking noise	Noise of the motorized valve when the unit is switched on.

Perking noise	Noise of the ventilation fan sucking in air present in the drain hose and blowing out dehumidifying water that had accumulated in the condensed water collector. For details, consult your sales agent.
Changing operation noise	Operation noise changes due to power variations according to room temperature changes.
Mist emission	Mist is generated as the air within the room is suddenly cooled by conditioned air.
Steam emitted from the outdoor unit	Water generated during defrosting operation evaporates and steam is emitted.
Odors	Caused as the smells and particles of smoke, food, cosmetics, etc. present in room air become attached the unit and blown off into the room again.
The outdoor unit continues to operate even if operation is stopped.	Defrosting is underway (as the heating operation is stopped, the microcomputer checks frost accumulated in the outdoor unit and instructs the unit to perform automatic defrosting if necessary).
The OPERATION lamp is blinking.	Shows preheating or defrosting operation is underway. As the protective circuit or preheat sensor operates when unit operation is stopped during preheating and then restarted, or when operation mode is switched from cooling to heating, the lamp continues to blink.
Does not reach the temperature setting	Actual room temperature may deviate slightly from the remote controller's temperature setting depending on the number of people in the room, indoor or outdoor conditions.

- If the unit still fails to operate normally after performing the above inspections, turn the circuit breaker off, or pull the power plug out, and contact your sales agent immediately.

Contact your sales agent immediately if the following phenomena should occur:

- The circuit breaker switches off or the fuse blows frequently.
- The switch operation is not stable.
- Foreign matter or water accidentally enters the unit interior.
- The power cord gets excessively hot or its insulation is torn or stripped.
- TIMER lamp on the indoor unit display blinks.



(As the nature of the failure can be identified by the blinking cycle, check the blinking cycle before turning off the circuit breaker.)



Notes

- In quiet operation or stopping the running, the following phenomena may occasionally occur, but they are not abnormal for the operation.
 - (1) Slight flowing noise of refrigerant in the refrigerating cycle.
 - (2) Slight rubbing noise from the fan casing which is cooled and then gradually warmed as operation stops.
- The odor will possibly be emitted from the room air conditioner because the various odor, emitted by smoke, foodstuffs, cosmetics and so on, sticks to it. So please clean the air filter and the evaporator regularly to reduce the odor.

- Please contact your sales agent immediately if the air conditioner still fails to operate normally after the above inspections. Inform your agent of the model of your unit, production number, date of installation. Please also inform him regarding the fault.

Please note:

On switching on the equipment, particularly when the room light is dimmed, a slight brightness fluctuation may occur. This is of no consequence.
The conditions of the local Power Supply Companies are to be observed.