

Flexible Ducting

GUIDE SHEET

Installation for Small Ducted Units

Introduction

The purpose of this guide is to provide information that assists installers to achieve the desired air flow from **temperzone** Split System Indoor units and Chilled Water Fan Coil units. It is also useful for investigating systems performing poorly.

Note: Many of these units are designed specifically for low static pressure drops therefore duct losses can be significant.

For simplicity, information is based on tests conducted using 250 mm diameter flexible duct. Smaller flexible duct diameters have worse characteristics than larger diameters.

General Rules

1. If a unit is supplied with specific size duct spigots, then **DO NOT** use ducting of a smaller size. If the duct run is more than 3 metres, stepping up to the next size is recommended.
2. If wanting to change the existing number of outlets on ISDL or IMDL low profile units, then the cross sectional area of the proposed new outlets must be **EQUAL TO OR GREATER** than that of the original outlets — it **MUST NOT BE LESS**.
3. **DO NOT** blank off an outlet at the spigot plate.
4. **AVOID** short outlet plenums with side outlets close to the unit, especially with draw-through units such as IMD and ISD models. This type of plenum generates high pressure losses, turbulence and noise. Longer plenums with side outlets away from the unit or short plenums with front outlets are preferred.

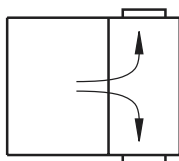

POOR

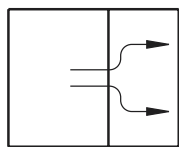

REASONABLE

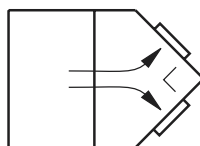

GOOD

5. Use radii of at least 1.5 times the duct diameter for bends. Tight radii bends can double the pressure loss.

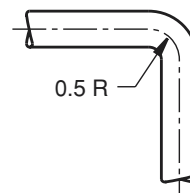

18 Pa @ 4.5 m/s

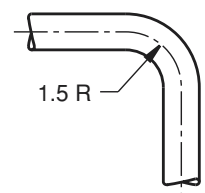

10 Pa @ 4.5 m/s

6. 180° 'U' bends surprisingly do not generate double the pressure loss of a 90° bend but something much less than double.

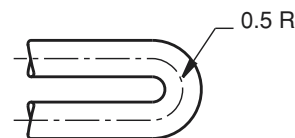

28 Pa @ 4.5 m/s

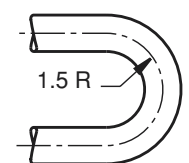

12 Pa @ 4.5 m/s

7. Avoid 'S' bends as these generate more than double the pressure loss of a 180° bend in fact about 2.5 times the pressure loss.

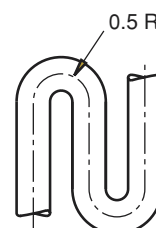

65 Pa @ 4.5 m/s

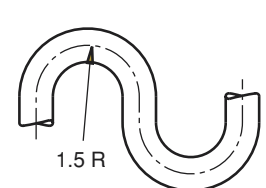

30 Pa @ 4.5 m/s

8. **DO NOT** mis-shape the circular ducting, i.e. don't squash it.

9. Side entry diffuser boxes generally have a much lower pressure loss than a top entry diffuser; top is satisfactory if the flexible duct is supported and makes a gentle radius entry ($1.5 \times$ duct diameter). However, if flexible duct is left unsupported then it will kink when connected to the diffuser adding dramatically to the pressure loss. Side entry boxes also improve air distribution.

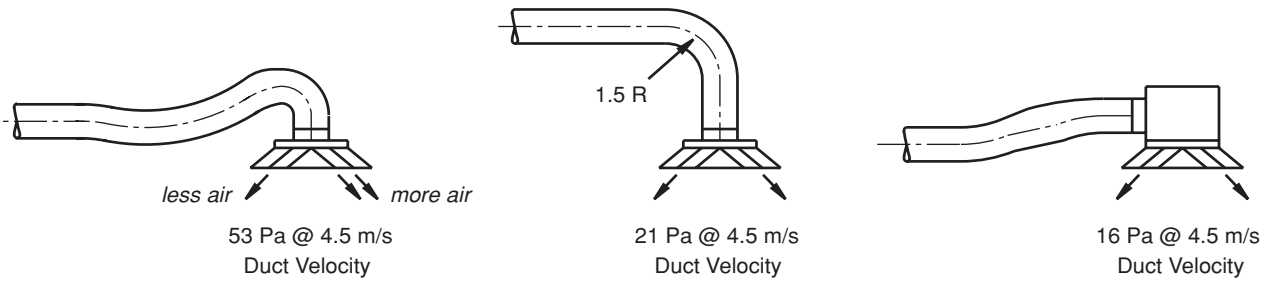

10. Oversize the flexible duct for long runs or better still incorporate some rigid straight circular duct.

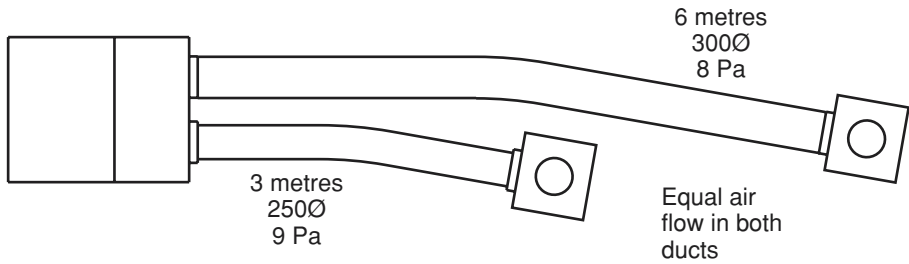

- 11. Try to achieve roughly equal pressure losses through each leg.
- 12. **DO NOT** coil up surplus flexible duct for short runs, **CUT** to suit.

Poor Installation

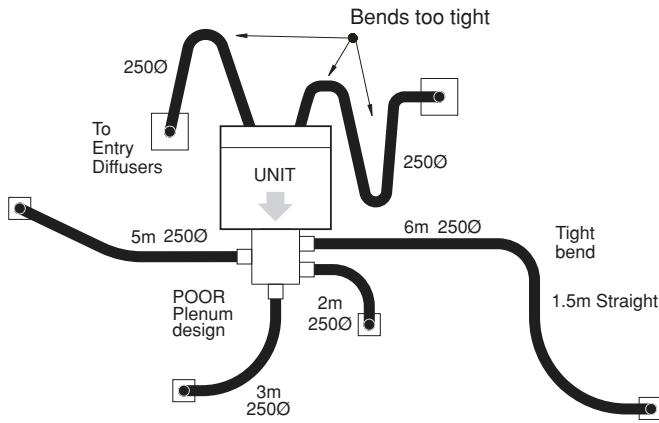

Ideal Installation

