

**HITACHI**  
Inspire the Next

***Installation  
&  
Maintenance  
Manual***

*INVERTER-DRIVEN  
MULTI-SPLIT SYSTEM  
HEAT PUMP  
AIR CONDITIONERS  
- SET-FREE SERIES -*

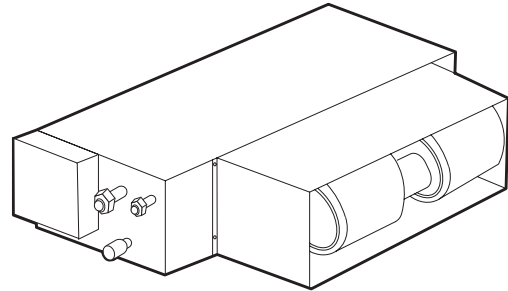

Type	Model
In-the-Ceiling (Duct)	RPI-3.0FSN2SQ
	RPI-4.0FSN2SQ
	RPI-5.0FSN2SQ
	RPI-6.0FSN2SQ
	RPI-7.0FSN2SQ

**IMPORTANT:**

*READ AND UNDERSTAND  
THIS MANUAL BEFORE  
USING THIS HEAT-PUMP  
AIR CONDITIONERS.  
KEEP THIS MANUAL FOR  
FUTURE REFERENCE.*

**P5414985**

**IMPORTANT NOTICE**

- HITACHI pursues a policy of continuing improvement in design and performance of products. The right is therefore reserved to vary specifications without notice.
- HITACHI cannot anticipate every possible circumstance that might involve a potential hazard.
- This heat pump air conditioner is designed for standard air conditioning only. Do not use this heat pump air conditioner for other purpose such as drying clothes, refrigerating foods or for any other cooling or heating process.
- Do not install the unit in the following places. It may cause a fire, deformation, corrosion or failure.
  - \* Places where oil (including machinery oil) may be present in quantities.
  - \* Places where a lot of sulfide gas drifts such as in a hot spring.
  - \* Places where inflammable gas may generate or flow.
  - \* Places where strong salty wind blows such as coast regions.
  - \* Places with an atmosphere of acidity or alkalinity.
- Do not install the unit in the place where silicon gas drifts. If the silicon gas attaches to the surface of heat exchanger, the fin surface repels water. As a result, drain water splashes outside of the drain pan and splashed water runs inside of electrical box. In the end, water leakage or electrical devices failure may occur.
- Pay attention to the following points when the unit is installed in a hospital or other facilities where an electromagnetic wave generates from a medical equipment.
  - \* Do not install the unit in the place where an electromagnetic wave is directly radiated to the electrical box, remote control cable or remote control switch.
  - \* Install the unit at least 3 meters away from an electromagnetic wave such as a radio.
- Do not install the unit in the place where the breeze directly catches animals and plants. It could adversely affect animals and plants.
- The installer and system specialist shall secure safety against the refrigerant leakage according to local regulations or standards. The following standards may be applicable, if local regulations are not available. International Organization for Standardization, ISO5149 or European Standard, EN378 or Japan Standard, KHKS0010.
- No part of this manual may be reproduced without written permission.
- It is assumed that this heat pump air conditioner will be operated and serviced by English speaking people. If this is not the case, the customer should be add safety, caution and operating signs in the native language.
- If you have any questions, contact your distributor or dealer of HITACHI.
- This manual gives a common description and information for this heat pump air conditioner which you operate as well for other models.
- This heat pump air conditioner has been designed for the following temperatures. Operate the heat pump air conditioner within this range.

Temperature		(°C)	
		Maximum	Minimum
Cooling Operation	Indoor	32 DB/23 WB	21 DB/15 WB
	Outdoor	46 DB *	-5 DB *
Heating Operation	Indoor	27 DB	15 DB
	Outdoor	15 WB *	-20 WB *

DB: Dry Bulb, WB: Wet Bulb

\* The temperature may change depending on the outdoor unit.

This manual should be considered as a permanent part of the air conditioning equipment and should remain with the air conditioning equipment.

## CHECKING PRODUCT RECEIVED

- Upon receiving this product, inspect it for any shipping damage. Claims for damage, either apparent or concealed, should be filed immediately with the shipping company.
- Check the model number, electrical characteristics (power supply, voltage and frequency) and accessories to determine if they are correct.

The standard utilization of the unit shall be explained in these instructions.

Therefore, the utilization of the unit other than those indicated in these instructions is not recommended.

Please contact your local agent, as the occasion arises.

HITACHI's liability shall not cover defects arising from the alteration performed by a customer without HITACHI's consent in a written form.

### **CAUTION**

Use shielded wires of operation line between the indoor and the outdoor unit. And connect the shielded part to the earth screw in the electrical box of the indoor unit as shown in the Fig. 1.

< Example: RPI-5.0FSN2SQ >

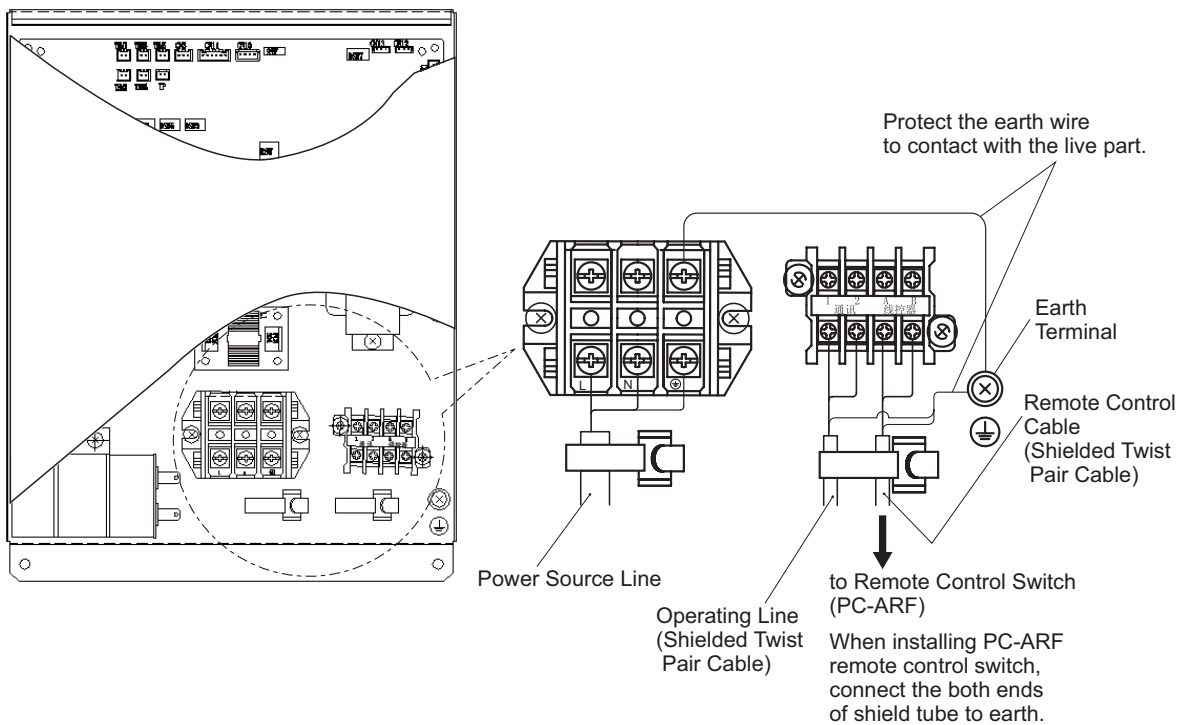

Fig. 1. Earth Wiring

## TABLE OF CONTENTS

1. Safety Summary .....	1
2. Structure .....	5
2.1 Name of Parts .....	5
2.2 Necessary Tools and Instrument List for Installation .....	7
3. Transportation and Handling.....	7
3.1 Transportation .....	7
3.2 Handling of Indoor Unit.....	7
4. Indoor Unit Installation .....	7
4.1 Factory-Supplied Accessories .....	7
4.2 Initial Check .....	9
4.3 Installation .....	10
4.3.1 Mounting on Truss .....	10
4.3.2 Separating Indoor Unit (If Required) (Only for 3.0 - 6.0HP Models).....	10
4.3.3 Mounting on Suspension Brackets (Field-Supplied).....	11
4.3.4 Adjusting of Unit Level .....	11
4.3.5 Connecting Supply Duct .....	12
4.3.6 Setting of External Static Pressure .....	12
5. Refrigerant Piping Work.....	13
5.1 Piping Materials.....	13
5.2 Piping Connection .....	13
6. Drain Piping .....	14
7. Electrical Wiring .....	15
7.1 General Check .....	15
7.2 Electrical Wiring Connection .....	15
7.3 Field Minimum Wire Sizes for Power Source .....	18
7.4 Setting of Dip Switches .....	19
7.5 Setting of External Static Pressure.....	20
8. Test Run .....	20
9. Safety and Control Device Setting .....	20

## 1. Safety Summary

< Signal Words >

- Signal words are used to identify levels of hazard seriousness.  
Definitions for identifying hazard levels are provided below with their respective signal words.

 : DANGER indicates a hazardous situation which, if not avoided, will result in death or serious injury.

 : WARNING indicates a hazardous situation which, if not avoided, could result in death or serious injury.

 : CAUTION, used with the safety alert symbol, indicates a hazardous situation which, if not avoided, could result in minor or moderate injury.

 : NOTICE is used to address practices not related to personal injury.

**NOTE** : NOTE is useful information for operation and/or maintenance.

** DANGER**

- Do not perform the installation work, refrigerant piping work, drain pump, drain piping and electrical wiring connection without referring to our installation manual. If the instructions are not followed, it may result in a water leakage, electric shock or a fire.
- Use the specified non-flammable refrigerant (R410A) to the outdoor unit in the refrigerant cycle.  
Do not charge material other than R410A into the unit such as hydrocarbon refrigerants (propane or etc.), oxygen, flammable gases (acetylene or etc.) or poisonous gases when installing, maintaining and moving. These flammables are extremely dangerous and may cause an explosion, a fire, and injury.
- Do not pour water into the indoor unit or outdoor unit. These products are equipped with electrical parts. If poured, it will cause a serious electrical shock.
- Do not open the service cover or access panel for the indoor or outdoor unit without turning OFF the main power supply.
- Do not touch or adjust safety devices inside the indoor unit or outdoor unit. If these devices are touched or readjusted, it may cause a serious accident.
- Refrigerant leakage can cause difficulty with breathing due to insufficient air. Turn OFF the main switch, extinguish any naked flames and contact your service contractor, if refrigerant leakage occurs.
- Make sure that the refrigerant leakage test should be performed.  
Refrigerant (Fluorocarbon) for this unit is non-flammable, non-toxic and odorless.  
However if the refrigerant is leaked and is contacted with fire, toxic gas will generate.  
Also because the fluorocarbon is heavier than air, the floor surface will be filled with it, which could cause suffocation.
- The installer and system specialist shall secure safety against refrigerant leakage according to local regulations or standards.
- Use an ELB (Earth Leakage Breaker).  
In the event of fault, there is danger of an electric shock or a fire if it is not used.
- Do not install the outdoor unit where there is high level of oil mist, flammable gases, salty air or harmful gases such as sulfur.
- For installation, firmly connect the refrigerant pipe before the compressor starts operating.  
For maintenance, relocation and disposal, remove the refrigerant pipe after the compressor stops.
- Do not perform a short-circuit of the protection device such as the pressure switch when operating.  
It may cause a fire and explosion.

**⚠ WARNING**

- Do not use any sprays such as an insecticide, lacquer, hair spray or other flammable gases within approximately one (1) meter from the system.
- If the circuit breaker or fuse is often activated, stop the system and contact your service contractor.
- Check that the ground wire is securely connected. If the unit is not correctly grounded, it lead electric shock. Do not connect the ground wiring to a gas piping, water piping, lighting conductor or ground wiring for telephone.
- Connect a fuse of specified capacity.
- Before performing any brazing work, check to ensure that there is no flammable material around. When using the refrigerant be sure to wear leather gloves to prevent cold injuries.
- Protect the wires, electrical parts, etc. from rats or other small animals. If not protected, rats may gnaw at unprotected parts and which may lead to a fire.
- Fix the cables securely. External forces on the terminals could lead to a fire.
- Provide a sufficiently strong foundation. If not, the unit may fall down and it may lead to injuries.
- Do not install the unit in a place where oil, vapor, organic solvent and corrosive gas (ammonia, sulfur compound and acid) may be present in quantities. It may cause refrigerant leakage due to corrosion, electrical shock, deteriorated performance and breakage.
- Perform the electrical work according to Installation Manual and all the relevant regulation and standards. If the instructions are not followed, an electrical shock and fire may occur due to insufficient capacity and inadequate performance.
- Use specified cables between units and choose the cables correctly. If not, an electrical shock or fire may occur.
- Ensure that the wiring terminals are tightened securely with the specified torques. If not, generating fire or an electric shock at the terminal connection part may occur

**⚠ CAUTION**

- Do not step or put any material on the product.
- Do not put any foreign material on the unit or inside the unit.
- Provide a strong and correct foundation so that;
  - a. The outdoor unit is not on an incline.
  - b. Abnormal sound dose not occur.
  - c. The outdoor unit will not fall down due to a strong wind or earthquake.

**NOTICE**

- Do not install the indoor unit, outdoor unit, remote control switch and cable within approximately 3 meters from strong electromagnetic wave radiators such as medical equipments.
- Supply electrical power to the system to energize the oil heater for 12 hours before startup after a long shutdown.
- Make sure that the outdoor unit is not covered with snow or ice, before operation.
- In some cases, the packaged air conditioner may not be operated normally under the following cases.
  - \* In case that electrical power for the packaged air conditioner is supplied from the same power transformer as the device\*.
  - \* In case that the power source wires for the device\* and the packaged air conditioner are located close to each other.

( Device\*: (Ex) Lift, container crane, rectifier for electric railway, inverter power device, arc furnace, electric furnace, large-sized induction motor and large-sized switch. )  
It consumes a large quantity of electrical power.

Regarding the cases mentioned above, surge voltage may be inducted in the power supply wiring for the packaged air conditioner due to a rapid change in power consumption of the device and an activation of switch.

Therefore, check the field regulations and standards before performing electrical work in order to protect the power supply for the packaged air conditioner.

**NOTE**

- It is recommended that the room will be ventilated every 3 to 4 hours.
- The heating capacity of the heat pump unit is decreased according to the outdoor air temperature. Therefore, it is recommended that auxiliary heating equipment be used in the field when the units is installed in a low temperature region.



## 2. Structure

### 2.1 Name of Parts

< RPI-3.0FSN2SQ - RPI-6.0FSN2SQ >

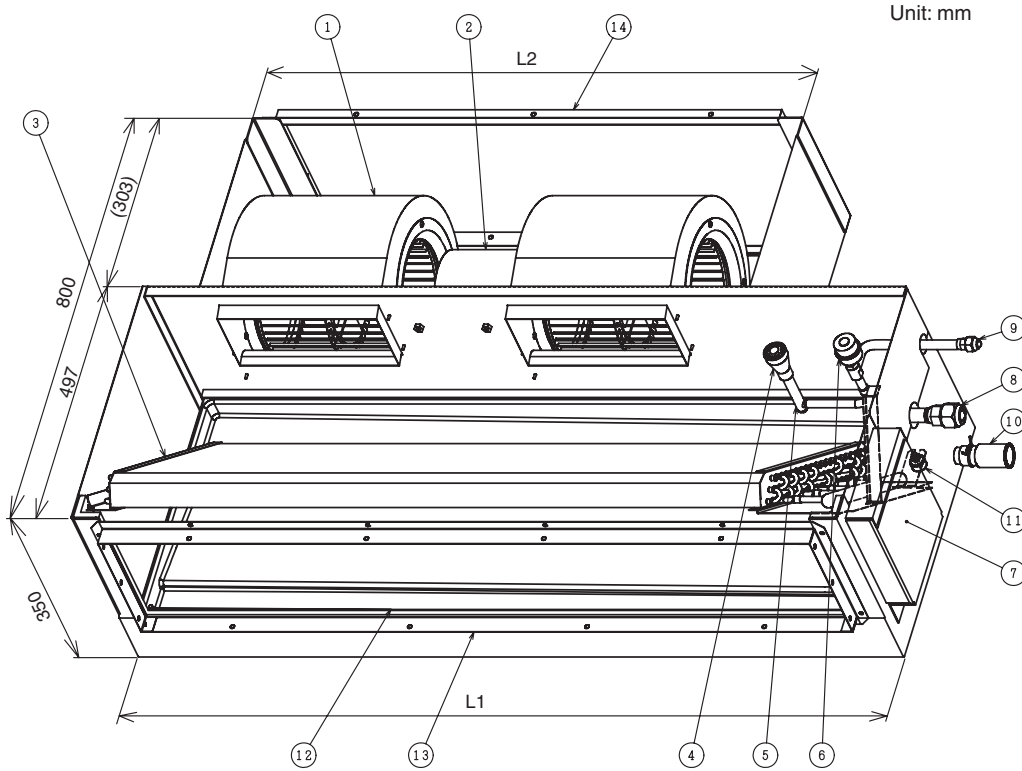

No.	Part Name
1	Fan
2	Fan Motor
3	Heat Exchanger
4	Distributor
5	Strainer
6	Micro-Computer Control Expansion Valve
7	Electrical Control Box
8	Refrigerant Gas Pipe Connection
9	Refrigerant Liquid Pipe Connection
10	Drain Pipe Connection
11	Float Switch
12	Drain Pan
13	Air Outlet
14	Air Inlet

Model	L1	L2
RPI-3.0FSN2SQ	1,076	879
RPI-4.0FSN2SQ	1,076	879
RPI-5.0FSN2SQ	1,300	1,000
RPI-6.0FSN2SQ	1,300	1,000

# IN-THE-CEILING (DUCT)

< RPI-7.0FSN2SQ >

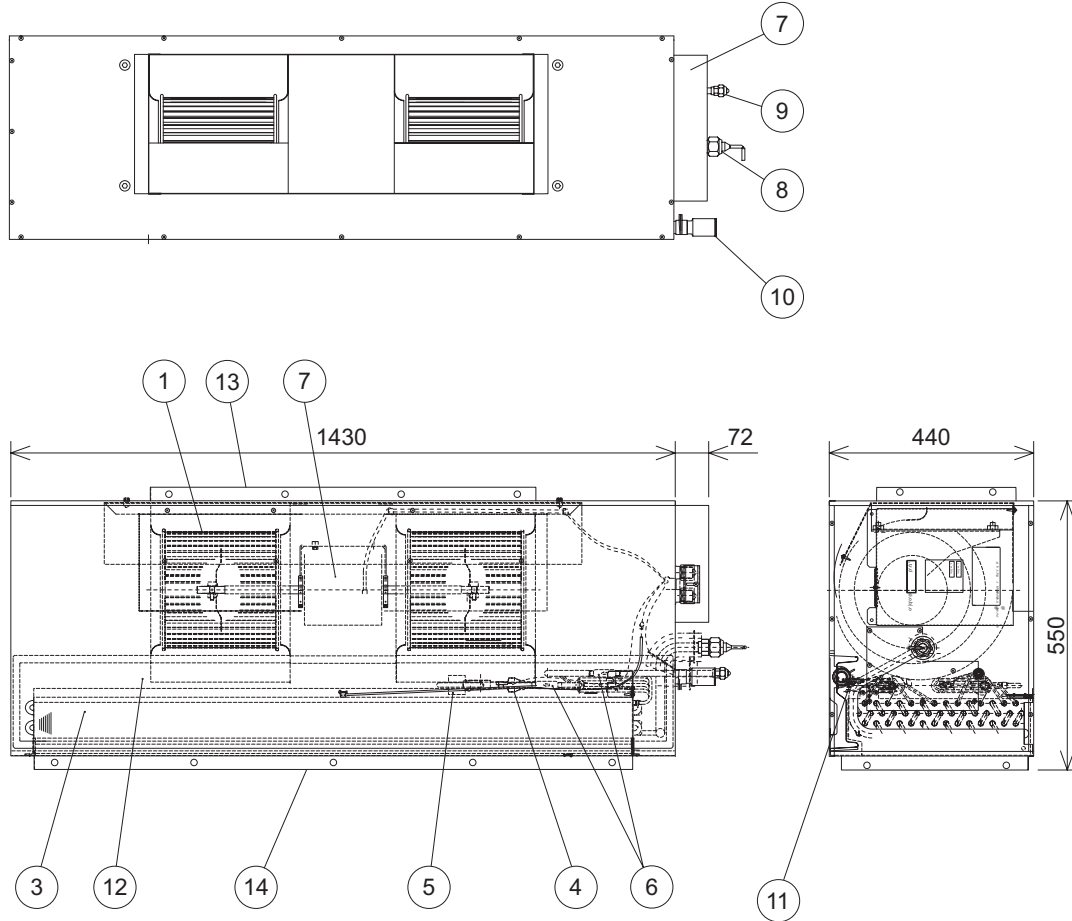

No.	Part Name
1	Fan
2	Fan Motor
3	Heat Exchanger
4	Distributor
5	Micro-Computer Control Expansion Valve
6	Strainer
7	Electrical Control Box
8	Refrigerant Gas Pipe Connection
9	Refrigerant Liquid Pipe Connection
10	Drain Pipe Connection
11	Float Switch
12	Drain Pan
13	Air Outlet
14	Air Inlet

## 2.2 Necessary Tools and Instrument List for Installation

No.	Tool	No.	Tool	No.	Tool
1	Handsaw	8	Plier	16	Cutter for Wires
2	Phillips Screwdriver	9	Pipe Cutter	17	Gas Leak Detector
3	Vacuum Pump	10	Brazing Kit	18	Leveller
4	Refrigerant Gas Hose	11	Hexagon Wrench	19	Clamper for Solderless Terminals
5	Megohmmeter	12	Spanner	20	Hoist (for Indoor Unit)
6	Copper Pipe Bender	13	Weigher	21	Ammeter
7	Manual Water Pump (for Indoor Unit)	14	Charging Cylinder	22	Voltage Meter
		15	Gauge Manifold	23	Wrench

### NOTE

About vacuum pump, gas hose, charging cylinder, gauge manifold, please use suitable equipments for R410A respectively. Do not mix other refrigerant.

## 3. Transportation and Handling

### 3.1 Transportation

Transport the product as close to the installation location as practical before unpacking.

#### CAUTION

Do not put any material on the product.

### 3.2 Handling of Indoor Unit

#### WARNING

Do not put any foreign material into the indoor unit and check to ensure that none exists in the indoor unit before the installation and test run. Otherwise, a fire or failure, etc. may occur.

#### CAUTION

Be careful not to damage on insulation materials of unit's surface when lifting.

## 4. Indoor Unit Installation

#### DANGER

Do not install the indoor unit in a flammable environment to avoid fire or an explosion.

#### WARNING

- Check to ensure that the ceiling slab is strong enough. If not strong enough, the indoor unit may fall down on you.
- Do not install the indoor unit outdoors. If installed outdoors, an electric hazard or electric leakage will occur.

It is recommended that indoor units be installed higher than 2.3 meters from the floor level.

### 4.1 Factory-Supplied Accessories





Check to ensure that the following accessories are packed with the indoor unit.

### NOTE

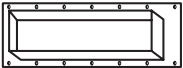
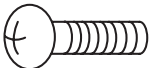

If any of these accessories are not packed with the unit, please contact your contractor.

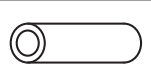
Table 4.1 Factory-Supplied Accessories

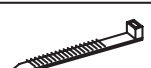
< RPI-3.0FSN2SQ - RPI-6.0FSN2SQ >

Accessory	Q'ty	Purpose
Flange 	1	For Air Outlet
Flange 	1	For Air Inlet
Screw 	16	For Fixing Flanges
Hose Clamp 	1	For Drain Hose Connection
Insulation (22 IDx130) 	1	For Refrigerant Liquid Piping
Insulation (40 IDx130) 	1	For Refrigerant Gas Piping
Cord Clamp 	10	For Fixing Thermal Insulation for Refrigerant Pipings

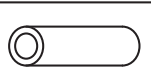
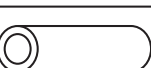
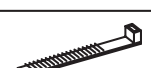
< RPI-7.0FSN2SQ >

Accessory	Q'ty	Purpose
Hose Clamp 	1	For Drain Hose Connection
Insulation (28 ID × 130) 	1	For Refrigerant Liquid Piping
Insulation (40 ID × 130) 	1	For Refrigerant Gas Piping
Cord Clamp 	10	For Fixing Thermal Insulation for Refrigerant Pipings
Bolt 	26	For Connecting Pipeline with Indoor Unit
Ring Core 	1	

4.2 Initial Check

- Install the indoor unit with a proper clearance around it for operation and maintenance working space, as shown in Fig. 4.1.

< RPI-3.0FSN2SQ - RPI-6.0FSN2SQ >

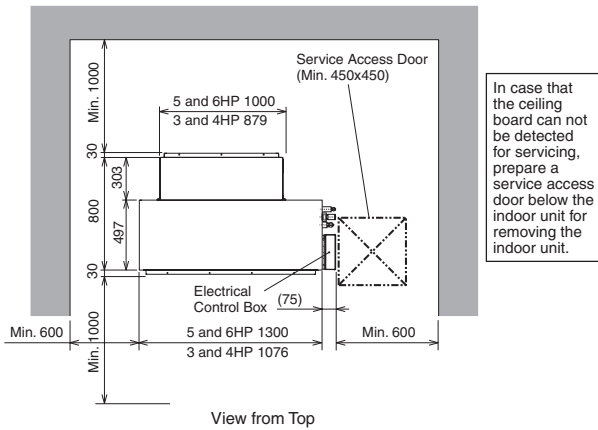

< RPI-7.0FSN2SQ >

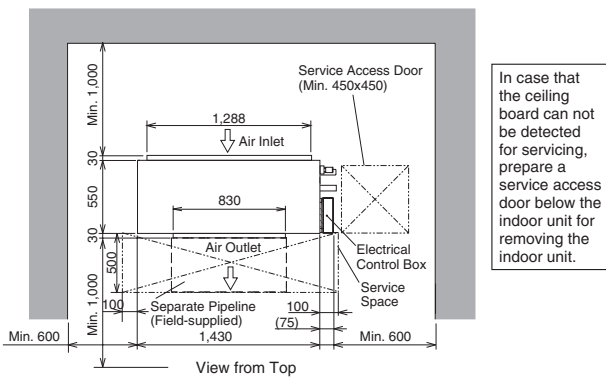

Fig. 4.1 Operation and Installation Space

- Consider the air distribution from the indoor unit to the space of the room, and select a suitable location so that uniform air temperature in the room can be obtained.
- Do not install flammable parts in the service space for the indoor unit.
- Avoid obstacles which may hamper the air intake or the air discharge flow.
- Do not install the indoor unit in a machine shop or kitchen where vapor from oil or its mist flows to the indoor unit.

The oil will deposit on the heat exchanger, thereby reducing the indoor unit performance, and may deform and in the worst case, break the plastic parts of the indoor unit.

- Pay attention to the following points when the indoor unit is installed in a hospital or other facilities where there are electronic waves from medical equipment.
  - (A) Do not install the indoor unit where the electromagnetic wave is directly radiated to the electrical box, remote control cable or remote control switch.
  - (B) Install the indoor unit and components as far as practical or at least 3 meters from the electromagnetic wave radiator.
  - (C) Prepare a steel box and install the remote control switch in it. Prepare a steel conduit tube and wire the remote control cable in it. Then, connect the ground wire with the box and the tube.
  - (D) Install a noise filter when the power supply emits harmful noises.
- To avoid any corrosive action to the heat exchangers, do not install the indoor unit in an acid or alkaline environment.

**! WARNING**

- Check to ensure that the number of below is within 0.3kg/m<sup>3</sup>. Otherwise it may cause danger situation if the refrigerant in the Outdoor Unit leaks into the room where this Indoor Unit is installed.

$$\frac{(\text{Total Refrigerant Quantity per one Outdoor Unit})}{(\text{Volume of the room where this Indoor Unit is installed.})} \leq 0.3\text{kg/m}^3$$

In detail, refer to the Installation Manual for outdoor unit.

**4.3 Installation**

**4.3.1 Mounting on Truss**

In the case that the indoor unit is installed in the false ceiling space without hanging, pay attention to the following items.

- (1) Apply vibration absorbing mats (10t) under the indoor unit.

< RPI-3.0FSN2SQ - RPI-6.0FSN2SQ >

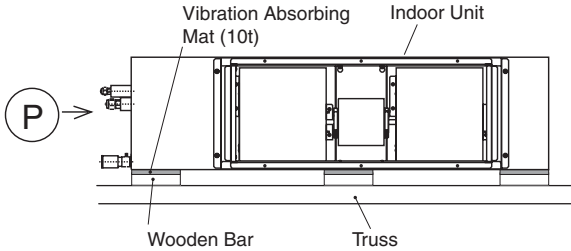

Place the three wooden bars on the truss as showing in the figure.  
Note that the middle wooden bar should be placed in the center position of the unit.

View from (P)

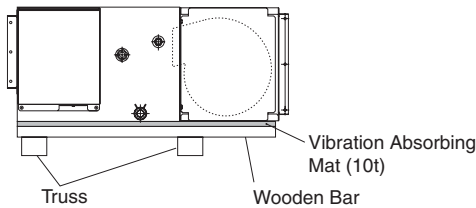

< RPI-7.0FSN2SQ >

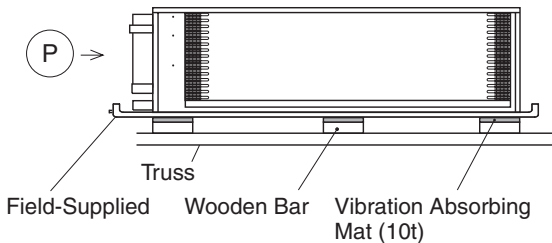

Place the three wooden bars on the truss as showing in the figure.  
Note that the middle wooden bar should be placed in the center position of the unit.

View from (P)

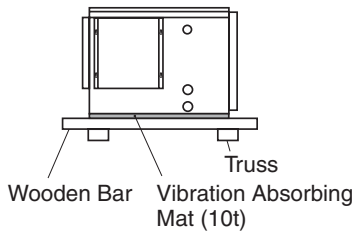

- (2) Apply an auxiliary drain under the indoor unit if the ambient humidity is higher than 80% (RH).

**4.3.2 Separating Indoor Unit (If Required)**  
(Only for 3.0 - 6.0HP Models)

**ATTENTION:**

**Separate the indoor unit only when necessary. Disassemble and reassemble on a flat surface.**

- Separate the indoor unit in the following order.
  - (1) Remove the 4 bolts (M6) on the back of the supply air box (Fig. 4.2).
  - (2) Carefully pull the fan cover away, taking care not to damage the fan motor wiring (Fig. 4.2).

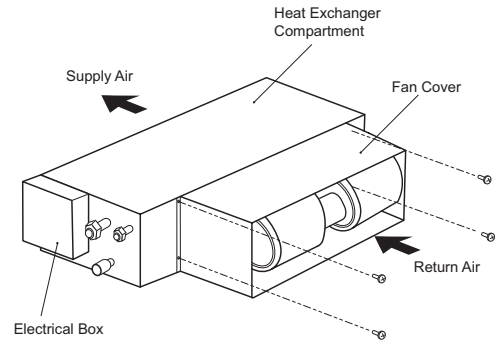
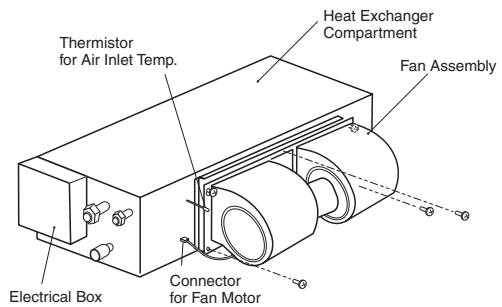

Fig. 4.2

- (3) If further disassembly is required, unplug the fan motor connector (Fig. 4.3).
- (4) Remove the 5 bolts (M6) securing the fan assembly to the heat exchanger compartment. The fan assembly will be lifted off (Fig. 4.3).

When removing the fan assembly, loosen the screws and lift off the fan assembly.

When attaching the fan assembly, mount it onto the screws as shown.



**NOTES:**

- 1) The fan cover has sharp edges. Take care not to injure yourself when handling.
- 2) Ensure not to damage or deform the air inlet temperature thermistor.
- 3) Check to ensure that the connector for the fan motor is connected to the unit.
- 4) Attach the fan cover as shown in the figure.

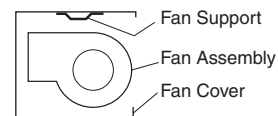

- 5) Tighten the screws securely. If they are loose, vibration or noise will occur.

Fig. 4.3 Removing Fan Assembly

- Rejoin the return air and supply air compartments in the following order.
  - (5) Carefully place the fan assembly back into the original position.
  - (6) Fix the fan assembly onto the heat exchanger compartment with 4 bolts (M6) (Fig. 4.3).
  - (7) Re-connect the fan motor connector into the plug on the heat exchanger compartment (Fig. 4.3).
  - (8) Carefully replace the fan cover, taking care not to damage the fan motor wiring, and fix the cover with the 4 bolts (M6) (Fig. 4.2).

**4.3.3 Mounting on Suspension Brackets (Field-Supplied)**

Mount the suspension brackets to the suspension bolts and secure them with nuts as shown. Use (field-supplied) angle and threaded rods, M10 or greater are also recommended to brace the unit mounting. (Check with local and national building codes and or a structural engineer as to the fixing of the unit or building support structure if applicable.)

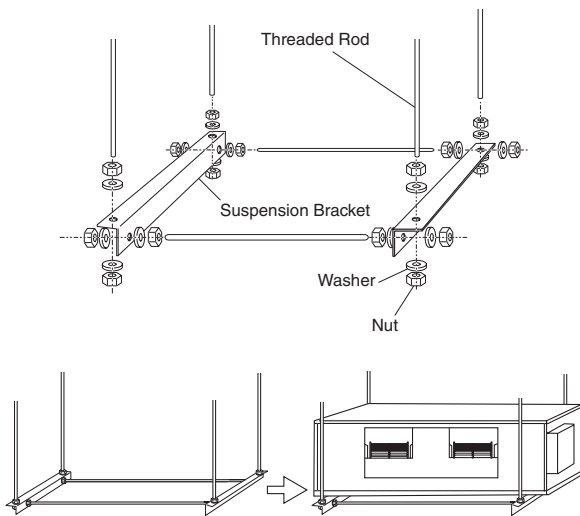

**4.3.4 Adjusting of Unit Level**

- (1) Check to ensure that the foundation is flat, taking into account the maximum foundation gradient.

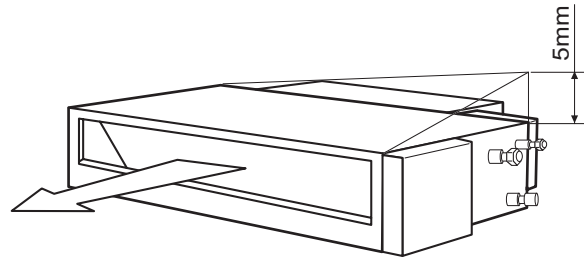

Fig. 4.4 Foundation Gradient

- (2) The unit should be installed so that the rear side of the unit is slightly (0mm to 5mm) lower than the front side, in order to avoid the incorrect position of the drain discharge.

**NOTE**

Keep the unit as well as relevant equipment covered with the vinyl cover during installation work.

## IN-THE-CEILING (DUCT)

### 4.3.5 Connecting Supply Duct

- (1) The supply duct should be connected with the indoor unit through canvas ducts, in order to avoid abnormal sound vibration (Refer to Fig. 4.5). The unit is equipped with a pre-drilled duct flange for the supply duct connection.
- (2) Attach the vibration proof rubber to Sling Bolt in order to avoid abnormal sound vibration.
- (3) Undamped natural frequency is shown in the table.
- (4) Duct material should be non-flammable material.
- (5) Perform the heat insulation work over the duct for dew protection.

HP	Undamped Natural Frequency
3.0	12 to 23 Hz
4.0	11 to 22 Hz
5.0	11 to 23 Hz
6.0	11 to 23 Hz
7.0	12 to 20 Hz

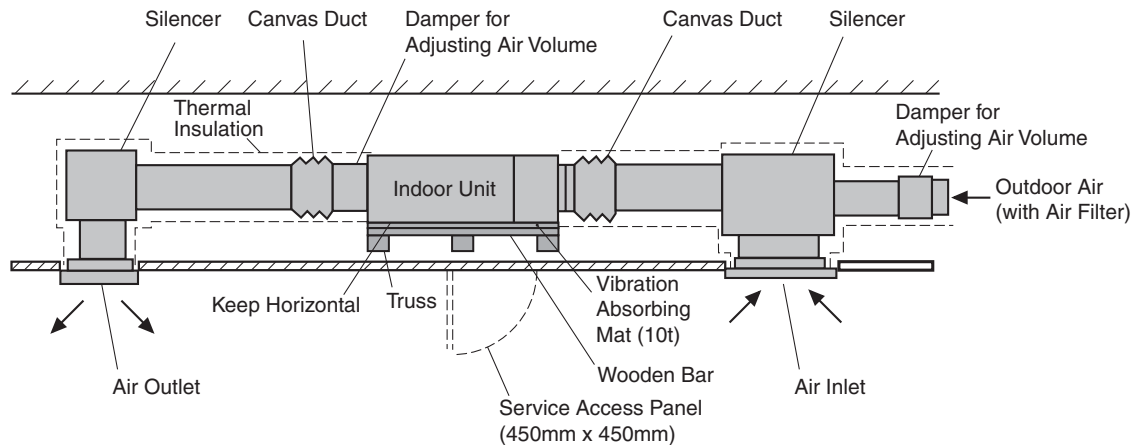

Fig. 4.5 Duct Connection

## CAUTION

- If a lower sound level is further required, install silencer (field-supplied).
  - Design duct arrangement as “Unit External Static Pressure=Pressure Drop of Duct+Pressure Drop of Air Outlet and Air Inlet”.
- If duct design is not appropriate, big sound and splash will occur.

### 4.3.6 Setting of External Static Pressure

Refer to 7.5 “Setting of External Static Pressure”.



## 5. Refrigerant Piping Work

### **! DANGER**

Use the specified non-flammable refrigerant (R410A) to the outdoor unit in the refrigerant cycle. Do not charge material other than R410A into the unit such as hydrocarbon refrigerants (propane or etc.), oxygen, flammable gases (acetylene or etc.) or poisonous gases when installing, maintaining and moving. These flammables are extremely dangerous and may cause an explosion, a fire, and injury.

### 5.1 Piping Materials

- (1) Prepare locally-supplied copper pipes.
- (2) Select clean copper tubes making sure there is no dust and moisture inside the tubes. Before connecting pipes, blow the inside of the tubes with nitrogen or dry air, to remove any dust or foreign materials.

### 5.2 Piping Connection

### **! CAUTION**

- Cap the end of the pipe when the pipe is to be inserted through a hole.
- Do not put pipes on the ground directly without a cap or vinyl tape at the end of the pipe.

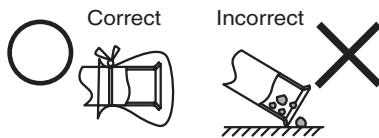

- An excess or a shortage of refrigerant is the main cause of trouble to the units. Charge the correct refrigerant quantity.

- (1) Position of piping connection is shown below.

< RPI-3.0FSN2SQ - RPI-6.0FSN2SQ >

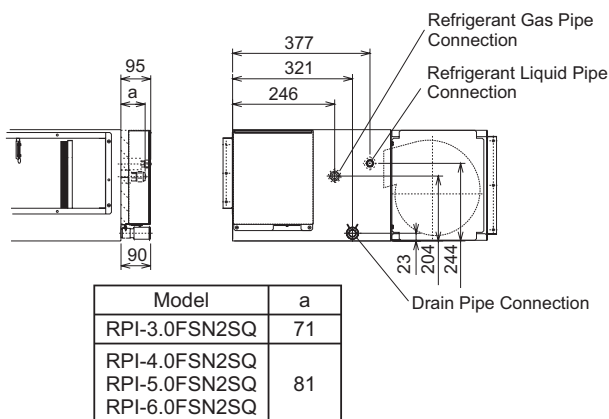

Fig. 5.1 Position of Piping Connection

Model	mm (in.)	
	Gas Piping	Liquid Piping
RPI-3.0FSN2SQ RPI-4.0FSN2SQ RPI-5.0FSN2SQ	φ15.88 (5/8)	φ9.52 (3/8)
RPI-6.0FSN2SQ	φ15.88 (5/8) or φ19.05 (3/4)*	

\*: When the pipe size of φ19.05 is used, apply the reducer (field-supplied) to fit the φ15.88 pipe for indoor unit connection.

< RPI-7.0FSN2SQ >

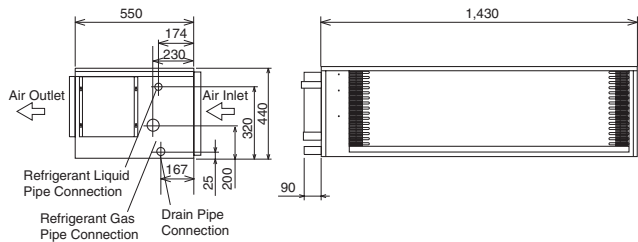

Fig. 5.2 Position of Piping Connection

- (2) When tightening the flare nut, use two spanners as shown in Fig. 5.3.



Pipe Size	Tightening Torque (N-m)
φ6.35mm	20
φ9.52mm	40
φ15.88mm	80
φ19.05mm	100

Fig. 5.3 Tightening Work of Flare Nut

- (3) After connecting the refrigerant piping, seal the refrigerant pipes by using the factory-supplied insulation material as shown in Fig. 5.4.

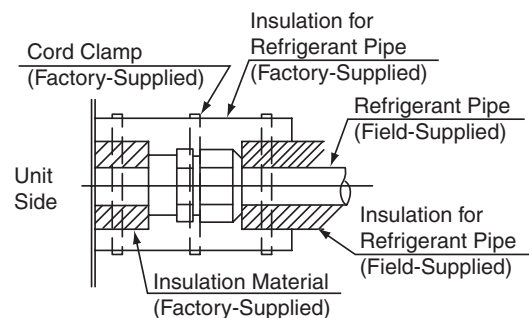

Fig. 5.4 Insulation on Pipes

- (4) Evacuation and refrigerant charging procedures should be performed according to "Installation & Maintenance Manual" of the outdoor unit.

**6. Drain Piping**

- (1) The position of the drain piping connection is shown in Fig. 6.1.
- (2) Prepare polyvinyl chloride pipe with a 32mm outer diameter.
- (3) Fasten the tube to the drain hose with the adhesive agent and the factory-supplied clamp. The drain piping must be performed with a DOWN-SLOPE pitch of 1/25 to 1/100.
- (4) Insulate the drain pipe after connecting the drain hose.

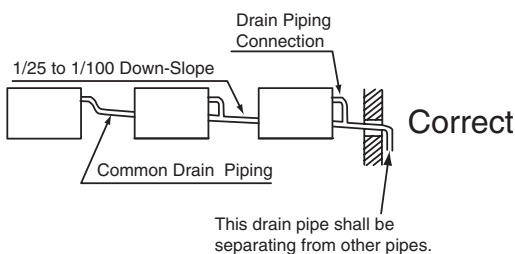
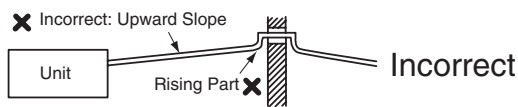
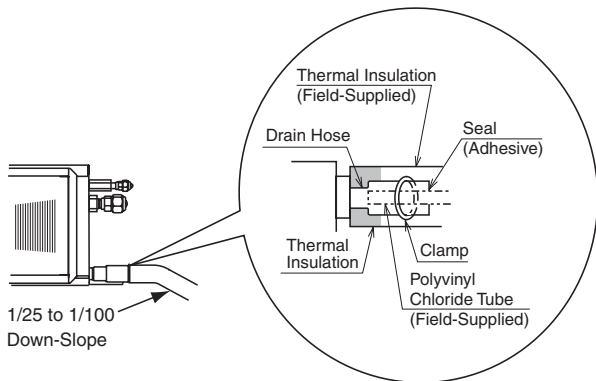

Fig. 6.1 Drain Piping

**NOTE**

When the relative humidity of inlet or ambient air exceeds 80%, apply an (field-supplied) auxiliary drain pan beneath the indoor unit as shown in Fig. 6.2.

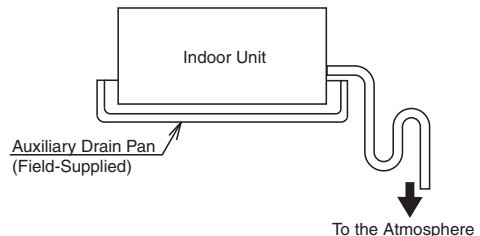

Fig. 6.2 Auxiliary Drain Pan

- (1) Do not create an upper-slope or rise for the drain piping, since drain water can flow back to the unit and leakage to the room will occur when the unit operation is stopped.
- (2) Do not connect the drain pipe with sanitary or sewage piping or any other drainage piping.
- (3) When the common drain piping is connected with other indoor units, the connected position of each indoor unit must be higher than the common piping. The pipe size of the common drain pipe must be large enough according to the unit size and number of units.
- (4) After performing drain piping work and electrical wiring, check to ensure that water flows smoothly as in the following procedure.
- (5) Checking with the Float Switch
  - a. Switch ON the power supply.
  - b. Pour 2 or 2.5 liters of water into the drain pan.
  - c. Check to ensure that the water flows smoothly or whether no water leakage occurs. When water cannot be found at the end of the drain piping, pour another 2 liters of water into the drain.

## 7. Electrical Wiring

### ⚠ WARNING

- Turn OFF the main power switch to the indoor unit and the outdoor unit before electrical wiring work or a periodical check is performed.
- Check to ensure that the indoor fan and the outdoor fan have stopped before electrical wiring work or a periodical check is performed.
- Protect the wires, drain pipe, electrical parts, etc. from rats or other small animals. If not protected, rats may gnaw at unprotected parts and at the worst, a fire will occur.
- Check the item below before turning ON the main switch.

In case that the power source for indoor unit is 220V (nominal voltage), change CN27 (connector) to CN28 of transformer (TF) in the electrical control box as shown in Fig. 7.1.

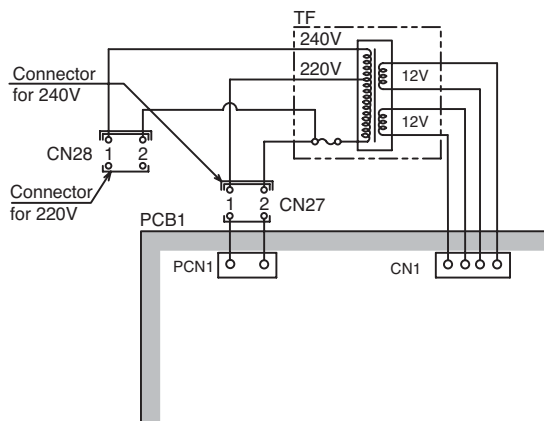

Fig. 7.1 Electrical Wiring Diagram of Transformer (TF)

- Tighten screws according to the following torque.

**M3.5: 1.2 N-m**

**M5: 2.0 to 2.4 N-m**

### ⚠ CAUTION

- Wrap the accessory packing around the wires, and plug the wiring connection hole with the seal material to protect the product from any condensate water or insects.
- Tightly secure the wires with the cord clamp inside the indoor unit.
- Secure the cable of the remote control switch using the cord clamp inside the electrical box.

#### 7.1 General Check

- (1) Make sure that the field-selected electrical components (main power switches, circuit breakers, wires, conduit connectors and wire terminals) have been properly selected according to the electrical data given in "Technical Catalog". Make sure that the components comply with National Electrical Code (NEC).
- (2) Check to ensure that the power supply voltage is within  $\pm 10\%$  of the rated voltage.
- (3) Check the capacity of the electrical wires. If the power source capacity is too low, the system cannot be started due to the voltage drop.
- (4) Check to ensure that the ground wire is connected.
- (5) Power Source Main Switch  
Install a multi-pole main switch with a space of 3.5mm or more between each phase.

#### 7.2 Electrical Wiring Connection

The electrical wiring connection for the indoor unit is shown in Fig. 7.2 (for 3.0 - 6.0HP models) or Fig. 7.3 (for 7.0HP model).

- (1) Connect the cable of an optional remote control switch or an optional extension cable to the connectors on the printed circuit board inside the electrical box through the connecting hole in the cabinet.
- (2) Connect the power supply and earth wires to the terminals in the electrical box.
- (3) Connect the wires between the indoor unit and the outdoor unit to the terminals in the electrical box.
- (4) Tightly clamp the wires using the cord clamp inside the electrical box.

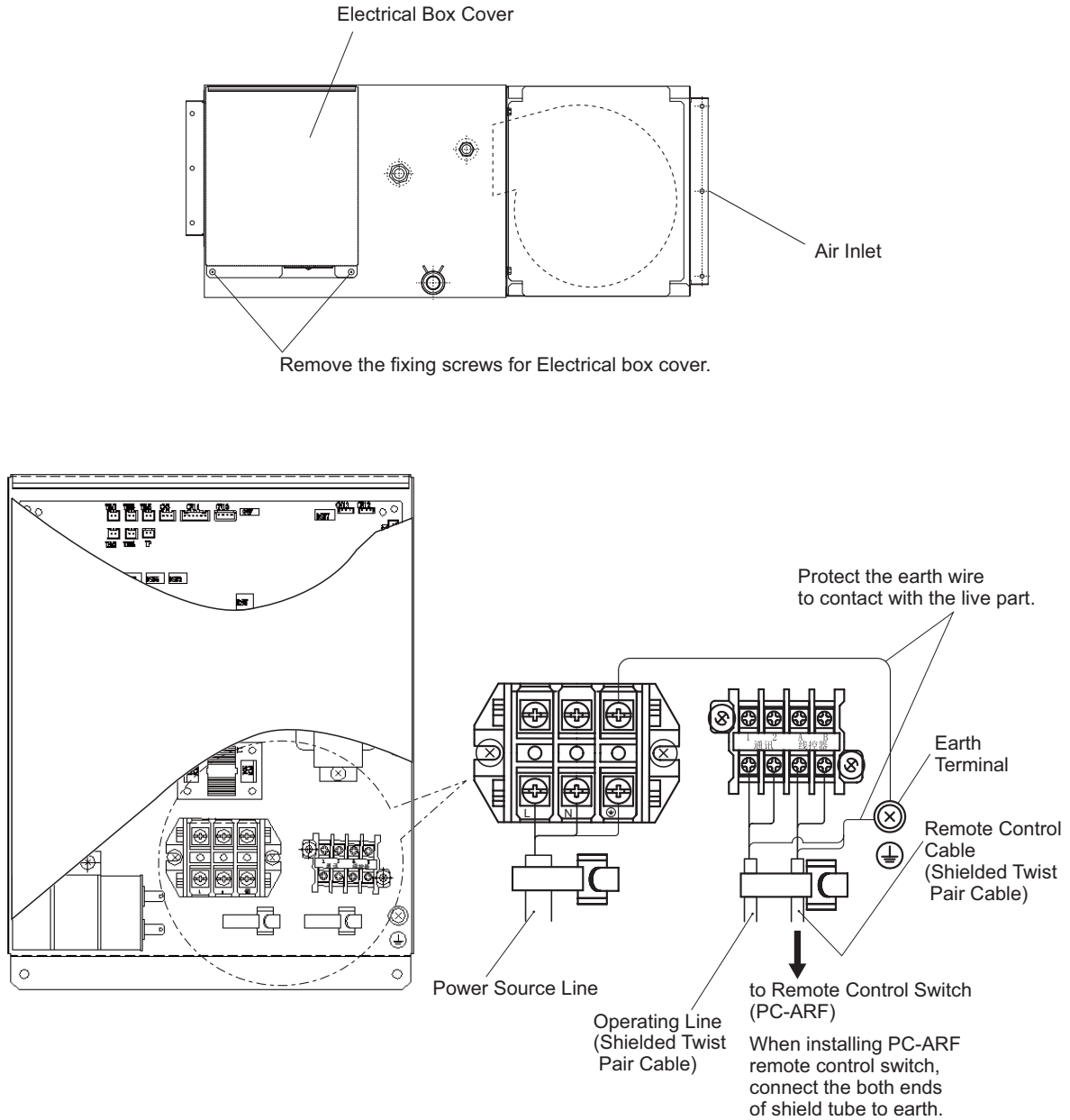

Fig. 7.2 Electrical Wiring Connection  
(Only for 3.0 - 6.0HP Models)

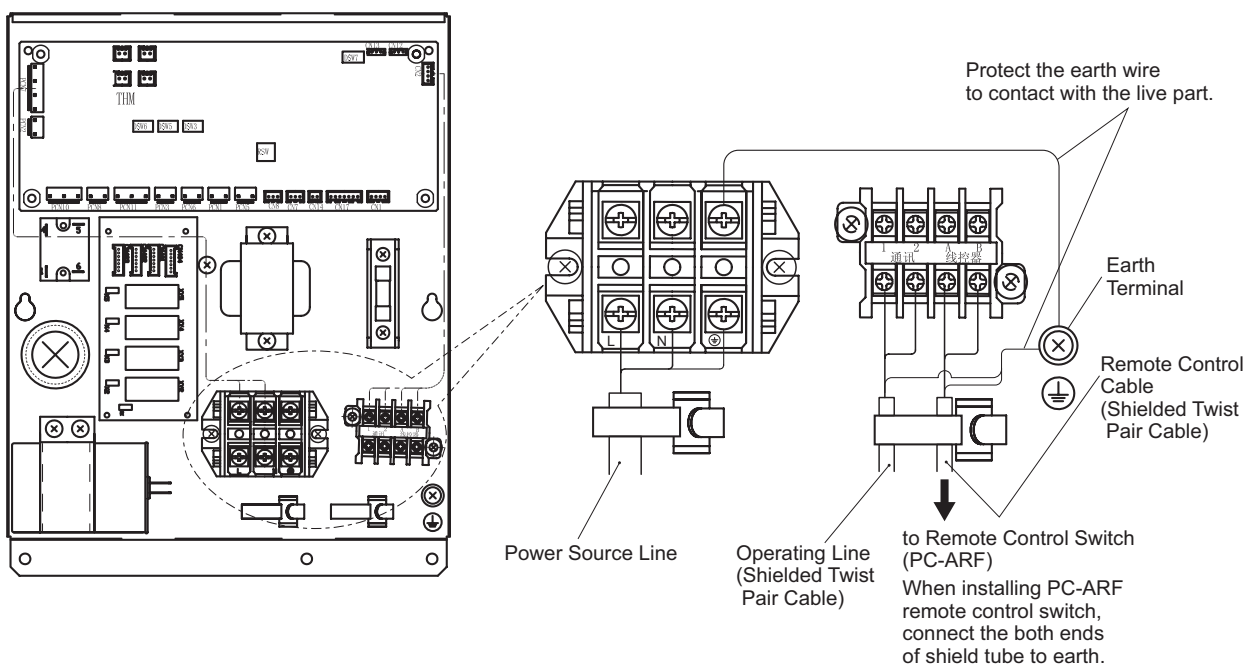
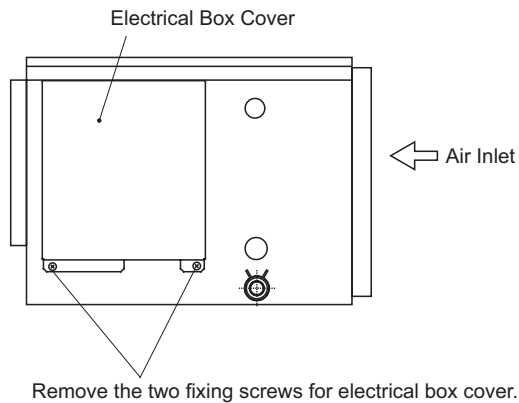

Fig. 7.3 Electrical Wiring Connection (Only for 7.0HP Model)

**ATTENTION:**

Attach the ring core (gray) (accessory) when installing the unit.

[Procedure]

Insert the controller cable into the ring core as shown in the below figure before connecting to the terminal board.

Fix the cable and the ring core by using the band (accessory).

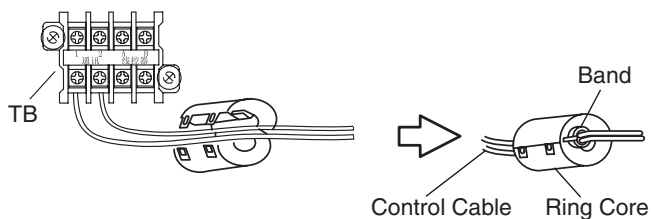

**7.3 Field Minimum Wire Sizes for Power Source**

- Use an ELB (Electric Leakage Breaker). If not used, it will cause an electric shock or a fire.
- Do not operate the system until all the check points have been cleared.
  - (A) Check to ensure that the electrical resistance is more than 1 megohm, by measuring the resistance between ground and the terminal of the electrical parts. If not, do not operate the system until the electrical leakage is found and repaired.
  - (B) Check to ensure that the stop valves of the outdoor unit are fully opened, and then start the system.
  - (C) Check to ensure that the switch on the main power source has been ON for more than 12 hours, to warm the compressor oil by the crankcase heater.
- Pay attention to the following items while the system is running.
  - (A) Do not touch any of the parts by hand at the discharge gas side, since the compressor chamber and the pipes at the discharge side are heated higher than 90°C.
  - (B) **DO NOT PUSH THE BUTTON OF THE MAGNETIC SWITCH(ES).** It will cause a serious accident.

Model	Power Source	Maximum Current	Power Source Cable Size		Transmitting Cable Size	
			IEC 60335-1 *1	MLFC *2	IEC 60335-1 *1	MLFC *2
RPI-3.0FSN2SQ RPI-4.0FSN2SQ RPI-5.0FSN2SQ RPI-6.0FSN2SQ	240V/ 1φ/50Hz	5A	0.75mm <sup>2</sup>	0.5mm <sup>2</sup>	0.75mm <sup>2</sup>	0.5mm <sup>2</sup>
RPI-7.0FSN2SQ		7A	1mm <sup>2</sup>	0.5mm <sup>2</sup>	1mm <sup>2</sup>	0.5mm <sup>2</sup>

**NOTES:**

- 1) Follow local codes and regulations when selecting field wires.
- 2) The wire sizes marked with \*1 in the table are selected at the maximum current of the unit according to the European Standard, IEC 60335-1. Use the wires which are not lighter than the ordinary tough rubber sheathed flexible cord (code designation H05RN-F) or ordinary polychloroprene sheathed flexible cord (code designation H05RN-F).
- 3) The wire sizes marked with \*2 in the table are selected at the maximum current of the unit according to the wire, MLFC (Flame Retardant Polyflex Wire) manufactured by Hitachi Cable Ltd., Japan.
- 4) Use a shielded cable for the transmitting circuit and connect it to ground.
- 5) In the case that power cables are connected in series, add each unit maximum current and select wires below.

**Selection According to IEC 60335-1**

Current i (A)	Wire Size (mm <sup>2</sup> )
i ≤ 6	0.75
6 < i ≤ 10	1
10 < i ≤ 16	1.5
16 < i ≤ 25	2.5
25 < i ≤ 32	4
32 < i ≤ 40	6
40 < i ≤ 63	10
63 < i	*3

**Selection According to MLFC (at Cable Temperature of 60°C)**

Current i (A)	Wire Size (mm <sup>2</sup> )
i ≤ 15	0.5
15 < i ≤ 18	0.75
18 < i ≤ 24	1.25
24 < i ≤ 34	2
34 < i ≤ 47	3.5
47 < i ≤ 62	5.5
62 < i ≤ 78	8
78 < i ≤ 112	14
112 < i ≤ 147	22

\*3: In the case that current exceeds 63A, do not connect cables in series.

**7.4 Setting of Dip Switches**

- (1) Turn OFF all the power supply to the indoor and the outdoor units before Dip Switch setting. If not, the setting is invalid.
- (2) The Dip Switch positions are as follows.

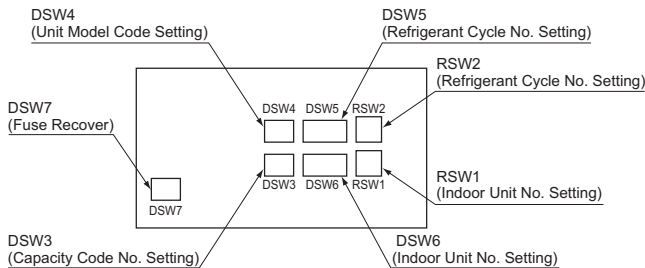

- (3) The PCB in the indoor unit is equipped with 2 rotary switches and 6 dip switches. Before testing unit, set these dip switches according to the following instructions. Unless these dip switches are set in the field, the unit can not be operated.

- (a) Unit No. Setting (RSW1 & DSW6)  
 Setting is required. Set the unit No. of all indoor units respectively and serially by following setting position shown in the table below. Numbering must start from "1" for every outdoor unit.

DSW6 (Tens Digit)	RSW1 (Units Digit)	Ex.) Set at No.16 Unit
	Setting Position: Set by inserting slotted screwdriver into the groove.	DSW6  Set No.1 Pin ON RSW1  Set at "6"
Before shipment, DSW6 and RSW1 are set to "0". Max. 64 units are available to set when all the equipment to be connected are corresponding to H-LINK II. Max. 16 units when the units corresponding/ non-corresponding to H-LINK II are combined.		

- (b) Capacity Code Setting (DSW3)  
 No setting is required, due to setting before shipment. This switch is utilized for setting the capacity code which corresponds to the Horse Power of the indoor unit.

Horsepower	3.0	4.0	5.0	6.0	7.0
Setting Position					

- (c) Unit Model Code Setting (DSW4)  
 No setting is required.  
 Setting the model code of the indoor unit.

Horsepower	3.0 - 6.0	7.0
Setting Position		

- (d) Refrigerant Cycle No. Setting (RSW2 & DSW5)  
 Setting is required. Setting positions before shipment are all OFF.

DSW5 (Tens Digit)	RSW2 (Units Digit)	Ex.) Set at No.5 Cycle
	Setting Position: Set by inserting slotted screwdriver into the groove.	DSW5  Set All Pins OFF RSW2  Set at "5"
Before shipment, DSW5 and RSW2 are set to "0". Max. 64 cycles are available to set when all the equipment to be connected are corresponding to H-LINK II. Max. 16 cycles when the units corresponding/ non-corresponding to H-LINK II are combined.		

- (e) Fuse Recover (DSW7)

\* Factory Setting

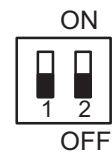

\* In the case of applying high voltage to the terminal 1, 2 of TB2, the fuse (0.5A) on the PCB, is cut. In such a case, firstly connect the wiring to TB2, and then turn on No.1 pin.

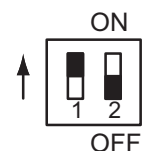

**NOTE**

The "■" mark indicates position of dip switches. Figures show setting before shipment.

**CAUTION**

**Before setting dip switches, firstly turn OFF power source and set the position of the dip switches. If the switches are set without turning OFF the power source, the switches can not function.**

**7.5 Setting of External Static Pressure**

The air flow volume can be changed according to the external static pressure by setting the item code to "C5" from the remote control switch (Refer to the Installation & Maintenance Manual of the remote control switch for details).

Model	External Static Pressure	Setting of Remote Control Switch
RPI-3.0FSN2SQ RPI-4.0FSN2SQ	70Pa	00 (Standard)
RPI-5.0FSN2SQ RPI-6.0FSN2SQ	120Pa	01 (High Static Pressure)
RPI-7.0FSN2SQ	140Pa	01 (High Static Pressure)

**8. Test Run**

Test run should be performed according to "Installation & Maintenance Manual" of the outdoor unit.

**! WARNING**

- **Do not operate the system until all the check points have been cleared.**
  - (A) **Check to ensure that the electrical resistance is more than 1 megohm, by measuring the resistance between ground and the terminal of the electrical parts. If not, do not operate the system until the electrical leakage is found and repaired.**
  - (B) **Check to ensure that the stop valves of the outdoor unit are fully opened, and then start the system.**
  - (C) **Check to ensure that the switch on the main power source has been ON for more than 12 hours, to warm the compressor oil by the crankcase heater.**
- **Pay attention to the following items while the system is running.**
  - (A) **Do not touch any of the parts by hand at the discharge gas side, since the compressor chamber and the pipes at the discharge side are heated higher than 90°C.**
  - (B) **DO NOT PUSH THE BUTTON OF THE MAGNETIC SWITCH(ES). It will cause a serious accident.**

**9. Safety and Control Device Setting**

Indoor Unit

Model			RPI-3.0FSN2SQ RPI-4.0FSN2SQ RPI-5.0FSN2SQ RPI-6.0FSN2SQ	RPI-7.0FSN2SQ
For Evaporator Fan Motor			Automatic Reset, Non-Adjustable (each one for each motor)	
Thermostat	Cut-Out	°C	135 ±5	140 ±5
	Cut-In	°C	86 ±15	86 ±15
For Control Circuit Fuse Capacity			5	
Freeze Protection				
Thermostat	Cut-Out	°C	0	
	Cut-In	°C	11	
Thermostat Differential			2	