

HITACHI

# SET FREE mini VRF

REVERSE CYCLE  
HNRQ SERIES



Cooling & Heating

# Welcome

## Air. It's a wonderful thing.

Invisible, silent and life-giving, air makes our entire world possible. It surrounds us, continuously energising, cooling and warming. It can be unpredictable and sometimes challenging, but when air is in harmony with us, everything seems that much easier.

**This is our vision.  
To create the air that makes life better.**



## Living Harmony

At Hitachi Cooling & Heating we like to think of this as creating harmony with your interior environment. When we achieve that wonderful balance, productivity, learning, happiness and health can thrive.

**We call this 'Living Harmony' and it's at the center of everything we do.**

## The future together

Living Harmony puts people first. By balancing the human needs of our customers with an uncompromising approach to innovation and quality, we can continue to create the technologies for a more comfortable and balanced world.

**Your world. We live in it together.**

## The beauty of balance

No matter what the weather is like outside, when you're indoors, you want to have complete control over your environment. At work or play, awake or asleep, you're free to create your own atmosphere; balancing energy with calm, sound with silence and light with shade. It's the same for cooling and heating.

**When the air around you is in balance, you can enjoy life indoors that much more.**



# Your world and Hitachi

WELCOME

## Live within a climate of your own making

Air ... To us it is something that is taken too much for granted.

So much so, that we can even forget it exists. Nevertheless, air is so essential that we could not go on living without it.

We believe that the ability to control the air indoors to our own liking, no matter what the environment outdoors, is a truly wonderful thing.

We want to create pleasant spaces of Living Harmony everywhere, for people all over the world.

With this thought in mind, we shall continue to produce technology that assures people can lead lives of comfort, safety and security.

## Design for tomorrow's urban spaces

Spaces in our cities are under increasing pressure. Urban areas demand landscape preservation, and also require space efficiency. SET FREE mini outdoor units have a simple yet stylish design that does not mar the urban appearance.

At the same time, since a powerful and compact unit runs multiple indoor units, it meets urban needs and the expectations of users who are concerned about the appearance of their surroundings.

## Redefining comfort

Comfort can be felt in a variety of ways, from the temperature to quietness and even the air flow itself. Our wide-ranging line-up of indoor units can match various comfort requirements.

## You are in control

Four types of individual controllers are available to match your needs: wireless and wired, and from advanced to simple. To manage energy and maintenance costs, our centralised controllers range from small to large. Select according to your needs, to enable your control.



**Introducing  
SET FREE mini**

# HELPING YOU FORM AN IDEAL LIVING ENVIRONMENT

We want to create a comfortable living environment where people can enjoy life to the full. SET FREE mini embodies such a wish. A host of outdoor units, indoor units and control devices matches the needs of various living spaces. Which is not only gratifying for the owners who use them, but also brings diverse benefits to architects, installers and other customers involved in space design.

## AESTHETICS

We can offer you a number of options that help enhance the aesthetics of your building.

- High external pressure of outdoor unit up to 30Pa (3-8HP Class)
- Fashionable outdoor and indoor unit appearance
- Large capacity outdoor unit saves installation space

## DESIGN FLEXIBILITY

Any local requirements and constraints can be met with a number of features in the outdoor unit.

- Flexibility up to 180m total liquid piping
- Wide range of indoor units availability
- High external pressure of outdoor unit
- Small body with large capacity

## HIGHER PERFORMANCE

We are committed to offering better energy-saving results with our improved outdoor units, indoor units and advanced control systems.

- DRED - Demand Response Enabling Device Availability
- Higher performance in both EER and COP
- Low standby power consumption design

## COMFORT

Our units offer you a degree of comfort, even in winter or in high humidity environments.

- 0.5°C setpoint
- Smart defrosting

## ADAPTABILITY

Both the quality and capability of adjustment to your environment are benefits of the HNRQ Series.

- Up to 52.0°C ambient temperature for cooling operations
- Noise reduction mode
- As low as -20.0°C ambient temperature for heating operations

## EASY INSTALLATION

Overall cost and time reduction can be achieved thanks to our newly designed outdoor units and original H-LINK system.

- Slim and lightweight body
- H-LINK
- Four directions of piping in outdoor unit
- Diagnostics using the outdoor unit's 7-segment displays

## EASY SERVICING AND MAINTENANCE

Our original transmission system, H-LINK, and newly improved PCB support smooth servicing and maintenance.

- H-LINK
- User-friendly service board for easier testing and diagnostics

## WARRANTY



Residential



Commercial



# Outdoor units

Owing to three types of outdoor unit with enhanced design and performance, we intelligently meet the requirements of various buildings as regards scale and construction, as well as air-conditioning needs. We believe that the paths to comfortable living all begin with Hitachi outdoor units.

## INDEX

06	LINE UP OVERVIEW
07	BETTER PERFORMANCE
08	COMFORT
09	DESIGN FLEXIBILITY
11	ADAPTABILITY
12	EASY INSTALLATION
13	SPECIFICATIONS

# LINE UP OVERVIEW

## OFFERING YOU THREE TYPES OF OUTDOOR UNITS



	Cooling Capacity	Heating Capacity	Weight
<b>3HP Class</b>	8.0kW	9.0kW	75kg
<b>3.5HP Class</b>	10.0kW	11.0kW	75kg

	Cooling Capacity	Heating Capacity	Weight
<b>4HP Class</b>	11.2kW	12.5kW	114kg
<b>4.5HP Class</b>	12.0kW	14.0kW	114kg
<b>5HP Class</b>	14.0kW	16.0kW	114kg
<b>6HP Class</b>	16.0kW	18.0kW	114kg
<b>6.5HP Class</b>	18.0kW	20.0kW	118kg

	Cooling Capacity	Heating Capacity	Weight
<b>7HP Class</b>	20.0kW	22.4kW	154kg
<b>8HP Class</b>	22.4kW	25.0kW	154kg
<b>10HP Class</b>	28.1kW	31.5kW	172kg
<b>11HP Class</b>	31.0kW	33.9kW	172kg
<b>12HP Class</b>	33.5kW	37.5kW	172kg

## SUMMARY TABLE

Item	Unit	HNRQ Series
Capacity	HP class	HP
	Nominal cooling	kW
	Nominal heating	kW
Connectable indoor unit quantity	unit	2-10 (15**)
Combination capacity ratio between ODU and IDU (all range)	%	50-130
Maximum piping length	Total liquid piping length	m
	Between outdoor unit and farthest indoor unit	m
	Between 1st branch multi kit and farthest indoor unit	m
	Between multi kit and each indoor unit	m
Maximum level difference	Between outdoor unit and indoor units (ODU above IDU)	m
	Between outdoor unit and indoor units (IDU above ODU)	m
	Between indoor units	m
Cooling operation range *	°C DB	-5.0 to 52.0
Heating operation range *	°C DB	-20.0 to 24.0

\* For more details, please consult your distributors or dealer, or, refer to technical manuals.  
 \*\* Numbers in parenthesis indicates the maximum number of indoor units that can be connected with in the restrictions.

# BETTER PERFORMANCE

## LOW STANDBY POWER CONSUMPTION DESIGN

Low standby power consumption design decreases the outdoor unit's standby power consumption from 20W to lower than 5W compared with the Previous Series.

Previous Series

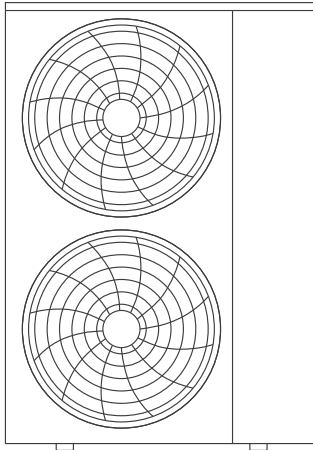

20W

HNRQ Series

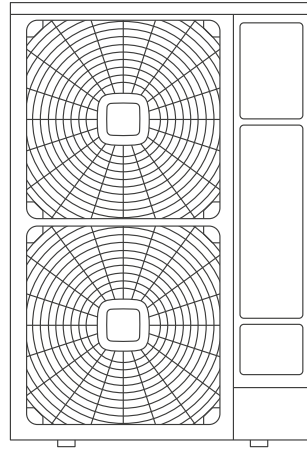

5W 

\* 3-6.5HP Class  
\* Please refer to the technical catalogue for more details.

### Outdoor unit capacity control ⇔ two options

(1) Peak-cut control:  
set the limit on the power consumption range

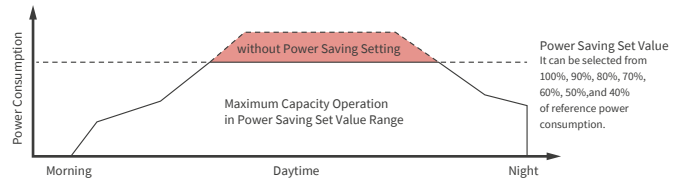
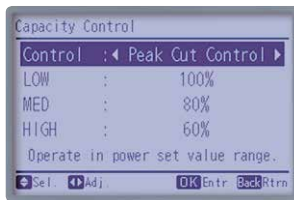

(2) Moderate control:  
keep the power consumption within proper limit (40-90%)

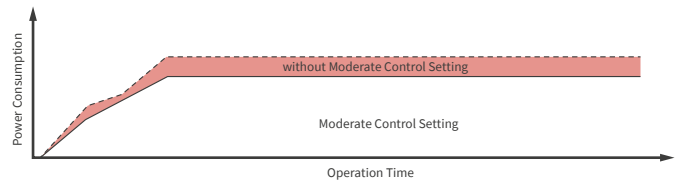
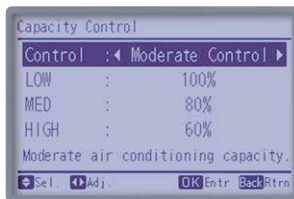



# COMFORT

## GENTLECOOL CONTROL



Set your comfortable temperature not only for "Room" but also for "Air" in cooling operation. To make your room reach to the desired temperature faster, the discharged air from the indoor unit can be sometimes much cooler, causing discomfort at the beginning of operation. Now, you can choose "discharge air temperature = your own comfort level", as you like, by our advanced wired remote controller PC-ARF1. You can be In comfort and avoid cold draft from the moment when cooling operation starts, while the room gently cools down.



"Comfort Setting" Control Cool Air in PC-ARFPE1

### Potential Discomfort



### GentleCool → No Cold Draft



## AWAY FUNCTION



Off set the temperature when the space is not occupied reducing the power consumption  
Optional accessories required

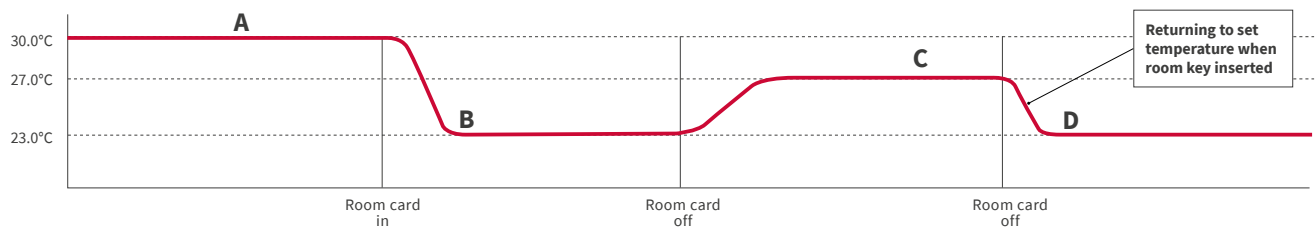
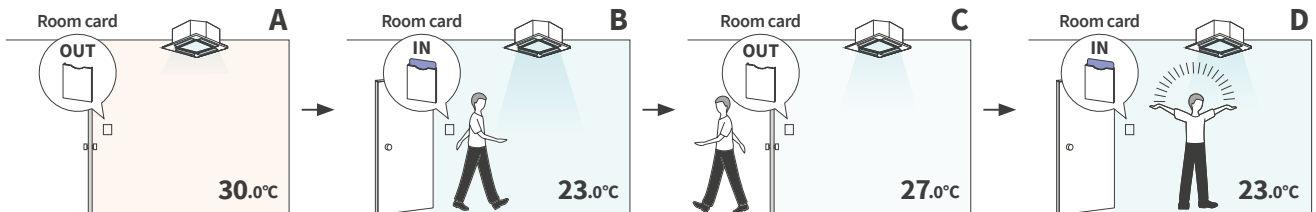

# DESIGN FLEXIBILITY

## PIPING FLEXIBILITY

Longer and more flexible piping has been realised.  
This helps in dealing with various piping restrictions.

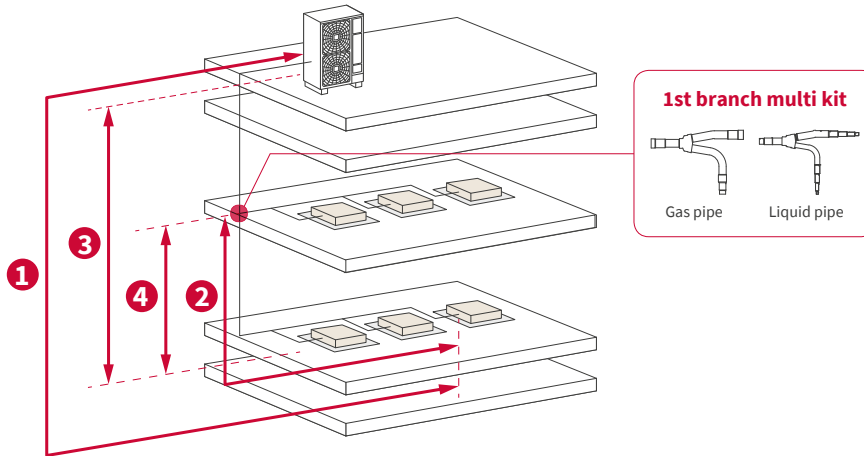

### Maximum piping length

	3-3.5HP Class	4-5HP Class	6-6.5HP Class	7-12HP Class
Total piping length	100m	120m	150m	180m
① Between outdoor unit and farthest indoor unit	65m	70m	85m	100m
② Between 1st branch multi kit and farthest indoor unit	40m	40m	40m	40m

### Maximum level difference

	3-3.5HP Class	4-5HP Class	6-6.5HP Class	7-12HP Class
③ Between outdoor unit and indoor units	ODU above IDU	30m	30m	50m
	IDU above ODU	30m	30m	40m
④ Between indoor units	15m	15m	15m	15m

Each maximum length or level difference has several conditions, please refer to the technical documents in inquiry.

## POWERFUL AIR

### High external pressure of outdoor unit

High external static pressure up to 30Pa is available in order to avoid air short-circuit conditions. This ensures that the outdoor unit runs with a good ventilating condition under different conditions of installation.

Our SET FREE mini outdoor units are designed to be located internally by the straightness of air flow thanks to higher external static pressure with DC inverter fan, leading to more options for installation and visual aesthetics of buildings.

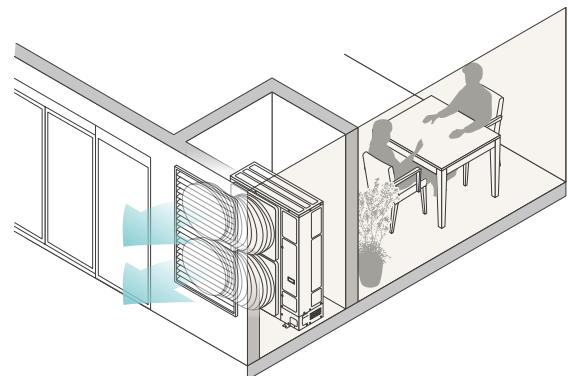
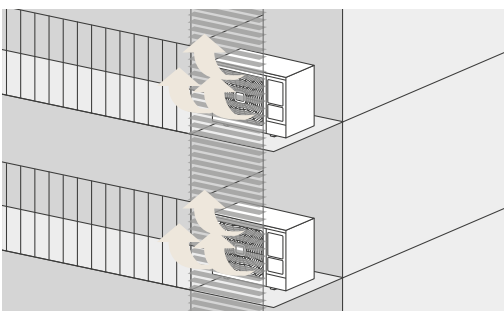

※ 30Pa is only available for between 3-8HP class

## SMALL BODY WITH LARGE CAPACITY

Since the HNRQ Series adopts a more compact outdoor unit compared with the top-blowing type large capacity outdoor unit, it offers an increased degree of freedom of installation.

### Height-limited space

#### Top-blowing type

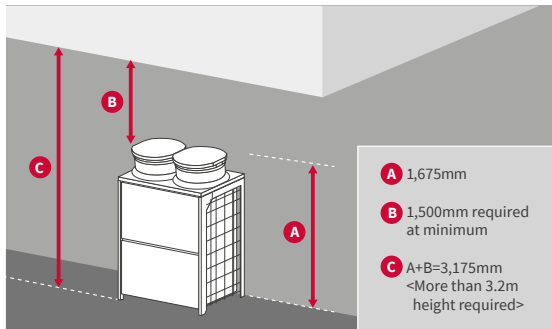

**Better limit in Height!**

#### HNRQ Series

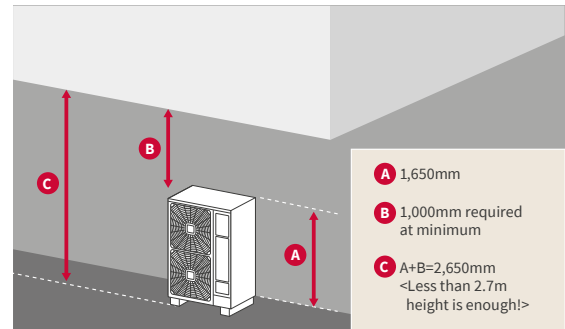

### Depth-limited space

#### Top-blowing type

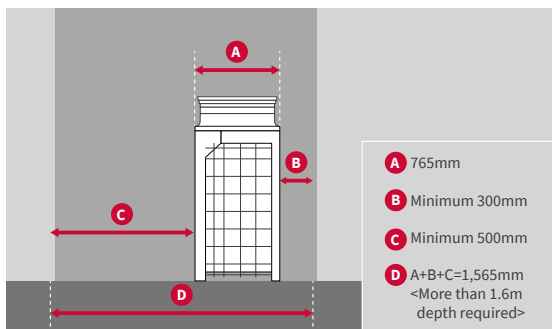

**Better limit in Depth!**

#### HNRQ Series

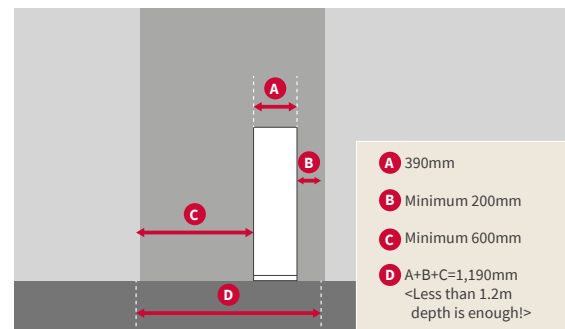

\* 8HP Class  
\* Please refer to the installation manual for more details.

## WIDE INDOOR UNIT COMBINATION

Because of the large-capacity outdoor unit, it is possible to install a whole range of indoor units in various rooms using one outdoor unit.

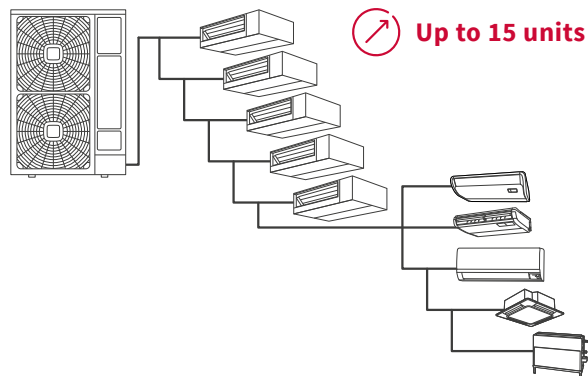

# ADAPTABILITY

## THE BEAUTY OF SILENCE

Balance is the key to harmony, so SET FREE mini outdoor units incorporates advanced features to ensure a more peaceful environment with less disturbance to the outside environment



## UP TO 52.0°C AMBIENT TEMPERATURE FOR COOLING OPERATIONS

- Up to 48.0°C stable running
  - Up to 52.0°C interval running
- Special fresh air intake and trapezoid heat sink design are adopted for the inverter driver. This improves heat emission and allows the system to be running stably under high ambient conditions.

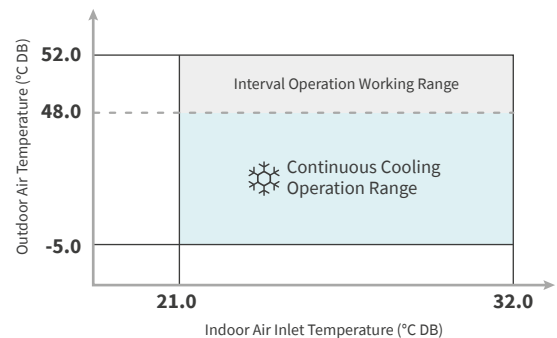

## AS LOW AS -20.0°C AMBIENT TEMPERATURE FOR HEATING OPERATIONS

- As low as -15.0°C stable running
  - As low as -20.0°C interval running
- Special 3-row coil design (3/3.5/6/6.5/10/11/12HP class) and larger area of coil enhance heating capability. This enables heating as low as -20.0°C ambient condition even in cold regions.

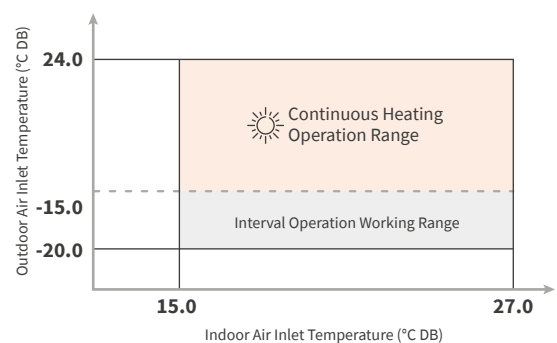

# EASY INSTALLATION

## FOUR DIRECTIONS OF PIPING IN OUTDOOR UNIT

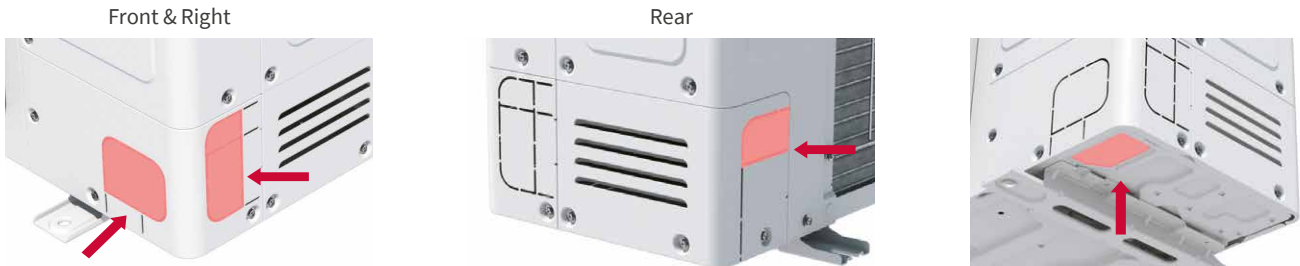

Stop valve built with 4-directional outlet piping for easier pipe installation. The refrigerant pipes can connect the stop valves from the front and right, rear and bottom of the unit.

## USER-FRIENDLY SERVICE BOARD FOR EASIER TESTING AND DIAGNOSTICS

User-friendly service board with dial code switch and push button is designed for easier testing and diagnostics. The service board, which is located in front of the outdoor unit, is easy to set.

### Functions are as follows:

- Monitoring real-time running status
- Displaying the fault code for diagnostics
- Checking historical fault information
- Optimising control parameters based on the installation field condition

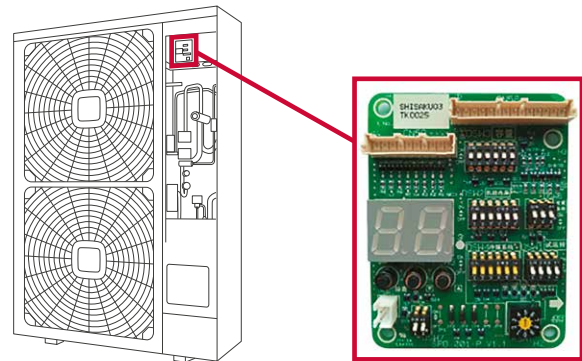

## H-LINK

H-LINK requires only two transmission wires connected to each outdoor unit for up to 64 refrigerant cycles, and connecting wires for all indoor units and outdoor units.

- Flexible installation options
- No polarity requirements
- Centralised Controller is enabled via indoor or outdoor unit
- Up to 160 indoor units and outdoor units can be connected
- Possible to have a cable length of up to 1,000m

### Centralised Controller to Outdoor Unit

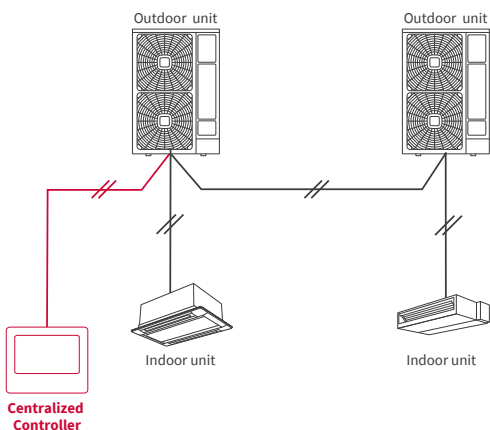

### Centralised Controller to Indoor Unit

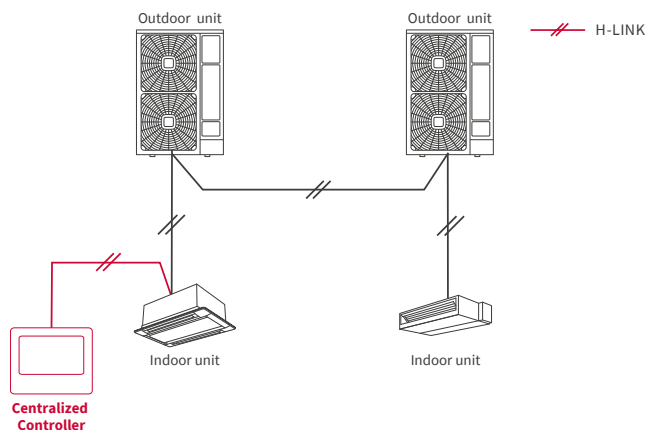

# SPECIFICATIONS

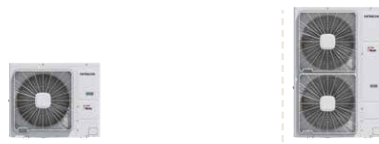

## HP Class

Model	unit	RAS-3.0HNBRKQ1	RAS-3.5HNBRKQ1	RAS-4.0HNBRKQ1	RAS-4.5HNBRKQ1	RAS-5.0HNBRKQ1	RAS-6.0HNBRKQ1	RAS-6.5HNBRKQ1	
Power Supply	V/Ph/Hz	220-240/1/50	220-240/1/50	220-240/1/50	220-240/1/50	220-240/1/50	220-240/1/50	220-240/1/50	
Capacity	Cooling	kW	8.00	10.00	11.20	12.00	14.00	16.00	18.00
	Heating	kW	9.00	11.00	12.50	14.00	16.00	18.00	20.00
Power Input	Cooling	kW	2.05	2.75	2.73	3.14	3.60	4.26	5.34
	Heating	kW	2.15	2.66	3.00	3.34	3.80	4.21	4.92
Air Flow Rate	Standard	m <sup>3</sup> /min	62	62	132	132	132	135	135
Dimensions	H×W×D	mm	800×950×320	800×950×320	1,380×950×320	1,380×950×320	1,380×950×320	1,380×950×320	1,380×950×320
Weight	Net	kg	75	75	114	114	114	118	118
Footprint Area		m <sup>2</sup>	0.31	0.31	0.31	0.31	0.31	0.31	0.31
Packaging Volume		m <sup>3</sup>	0.48	0.48	0.77	0.77	0.77	0.77	0.77
Compressor Type			Twin Rotary	Twin Rotary	Twin Rotary	Twin Rotary	Twin Rotary	Twin Rotary	
Refrigerant	Type		R410A	R410A	R410A	R410A	R410A	R410A	
	Charge Amount	kg	3.0	3.0	4.1	4.1	4.1	4.4	4.4
Refrigerant Oil	Model		α 68HES-H	α 68HES-H	α 68HES-H	α 68HES-H	α 68HES-H	α 68HES-H	
	Charge Amount	L	1.02	1.02	1.65	1.65	1.65	1.65	1.65
Number of Fan Motors			1	1	2	2	2	2	
Capacity Ratio of IDU/ODU	%		50-130%	50-130%	50-130%	50-130%	50-130%	50-130%	
Sound Pressure Level	Semi-anechoic	dB(A)	51	53	54	54	54	55	55
Piping	Liquid	mm	φ9.52	φ9.52	φ9.52	φ9.52	φ9.52	φ9.52	
	Gas	mm	φ15.88	φ15.88	φ15.88	φ15.88	φ15.88	φ15.88	
Connectable IDU Qty			2-4	2-5	2-6	2-7	2-8	2-9	
Working Temp. Range	Cooling		Stable Work at -5.0~48.0°C DB and Interval at 48.0~52.0°C DB						
	Heating		Stable Work at -15.0~24.0°C DB and Interval at -20.0~-15.0°C DB						
Refrigerant Control Mode			Microcomputer-controlled Electronic Expansion Valve						
Electronic Expansion Valve									
Tubing Connection Method			Flare Connection						
Maximum Piping Length	Total Liquid Pipe Length	m	100	100	120	120	120	150	150
	Between ODU and farthest IDU	m	65	65	70	70	70	85	85
	Between 1st Branch Multi Kit and Farthest IDU	m	40	40	40	40	40	40	40
	Between Each Multi Kit and Each IDU	m	15	15	15	15	15	15	15
Maximum Level Difference	Between ODU and IDU	m	30	30	30	30	30	30	30
	Between IDUs	m	15	15	15	15	15	15	15

### Notes:

1. The EER and COP are tested under the following working conditions, when the outdoor unit is connected to the special combination of indoor units.

Working conditions for testing EER

- Indoor temperature: 27.0°C DB/19.0°C WB
- Outdoor temperature: 35.0°C DB
- Pipe length: 10.0 metre
- Pipe lift: 0 metre

Working conditions for testing COP

- Indoor temperature: 20.0°C DB
- Outdoor temperature: 7.0°C DB/6.0°C WB
- Pipe length: 10.0 metre
- Pipe lift: 0 metre

2. Noise test conditions are specified below: Noise is tested 1.5 metre above ground level and 1.0 metre away from the surface of the external service board on the outdoor unit. Noise parameters are tested in a semi-anechoic chamber.

## OPTIONAL PARTS

### MULTI-KIT

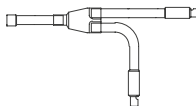

E-102SN



HP Class

Model

			7	8	10	11	12
			RAS-7.0HNBRMQ1	RAS-8.0HNBRMQ1	RAS-10HNBRMQ1	RAS-11HNBRMQ1	RAS-12HNBRMQ1
Power Supply	V/Ph/Hz		380-415/3/50	380-415/3/50	380-415/3/50	380-415/3/50	380-415/3/50
Capacity	Cooling	kW	20.00	22.40	28.10	31.00	33.50
	Heating	kW	22.40	25.00	31.50	33.90	37.50
Power Input	Cooling	kW	5.40	6.38	7.84	8.87	10.40
	Heating	kW	5.60	6.04	8.19	9.42	10.74
Air Flow Rate	Standard	m <sup>3</sup> /min	162	162	172	172	172
Dimensions	H×W×D	mm	1,650×1,100×390	1,650×1,100×390	1,650×1,100×390	1,650×1,100×390	1,650×1,100×390
Weight	Net	kg	154	154	172	172	172
Footprint Area		m <sup>2</sup>	0.43	0.43	0.43	0.43	0.43
Packaging Volume		m <sup>3</sup>	1.04	1.04	1.04	1.04	1.04
Compressor Type			Scroll	Scroll	Scroll	Scroll	Scroll
Refrigerant	Type		R410A	R410A	R410A	R410A	R410A
	Charge Amount	kg	5.5	5.5	6.5	6.5	6.5
Refrigerant	Model		FV68H	FV68H	FV68H	FV68H	FV68H
Oil	Charge Amount	L	1.60	1.60	1.60	1.60	1.60
Number of Fan Motors			2	2	2	2	2
Capacity Ratio of IDU/ODU	%		50-130%	50-130%	50-130%	50-130%	50-130%
Sound Pressure Level	Semi-anechoic	dB(A)	56	56	59	59	60
Piping	Liquid	mm	φ9.52	φ9.52	φ12.7	φ12.7	φ12.7
	Gas	mm	φ19.05	φ19.05	φ19.05*	φ19.05**	φ19.05**
Connectable IDU Qty			2~10	2~10	2~10 (13)***	2~10 (14)***	2~10 (15)***
Working Temp. Range	Cooling		Stable Work at -5.0~48.0°C DB and Interval at 48.0~52.0°C DB				
	Heating		Stable Work at -15.0~24.0°C DB and Interval at -20.0~-15.0°C DB				
Refrigerant Control Mode			Microcomputer-controlled Electronic Expansion Valve				
Electronic Expansion Valve							
Tubing Connection Method			Flare Connection				
Maximum Piping Length	Total Liquid Pipe Length	m	180	180	180	180	180
	Between ODU and farthest IDU	m	100	100	100	100	100
	Between 1st Branch Multi Kit and Farthest IDU	m	40	40	40	40	40
	Between Each Multi Kit and Each IDU	m	15	15	15	15	15
Maximum Level Difference	Between ODU and IDU	m	50	50	50	50	50
	Between IDUs	m	40	40	40	40	40
		m	15	15	15	15	15

\* Indicates that there are pipe adapters in the outdoor unit, which are used to adjust the gas pipe between the outdoor unit and the first branch. Thus the φ19.05 diameter pipe is converted to φ22.2 diameter pipe in the model.  
 \*\* Indicates that there is a pipe adapter in the model, which is used to adjust the gas pipe length between the outdoor unit and the first branch. Thus the φ19.05 diameter pipe is converted to a φ25.4 diameter pipe.  
 \*\*\* Numbers in parenthesis indicate the maximum number of indoor units that can be connected with certain limitations. Please contact the manufacturer for more details.

Notes:

1. The EER and COP are tested under the following working conditions, when the outdoor unit is connected to the special combination of indoor units.

Working conditions for testing EER

- Indoor temperature: 27.0°C DB/19.0°C WB
- Outdoor temperature: 35.0°C DB
- Pipe length: 10.0 metre
- Pipe lift: 0 metre

Working conditions for testing COP

- Indoor temperature: 20.0°C DB
- Outdoor temperature: 7.0°C DB/6.0°C WB
- Pipe length: 10.0 metre
- Pipe lift: 0 metre

2. Noise test conditions are specified below: Noise is tested 1.5 metre above ground level and 1.0 metre away from the surface of the external service board on the outdoor unit. Noise parameters are tested in a semi-anechoic chamber.

OPTIONAL PARTS

MULTI-KIT

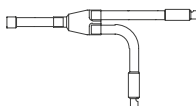

E-102SN



# Indoor units

SET FREE mini offers a variety of indoor units in its line-up to achieve comfortable air conditioning that flexibly addresses various applications and shapes of space. By raising the "quality" of the air, we believe that the "quality" of time customers spend there will also be enhanced.













## INDEX

16	LINE UP OVERVIEW
19	DUCTED
25	CONCEALED & EXPOSED
28	CEILING CASSETTE



# LINE UP OVERVIEW

## COMPARING VRF INDOOR UNIT RANGE











IDU Category	Cooling (kW)	2.2	2.8	3.6	4.0	5.0	5.6	6.3	7.1	8.0	8.4	9.0	11.2	14.0	14.2	16.0	
<b>DUCTED</b>	HIGH ESP TYPE [RPI-FSN3]						●		●	●			●	●		●	
	MEDIUM ESP TYPE		●	●		●	●		●	●			●	●		●	
	HIGH ESP TYPE [RPIH-HNAUNQ]										●	●	●		●	●	
	COMPACT TYPE (BOTH AC MOTOR TYPE AND DC MOTOR TYPE AVAILABLE)		●	●	●	●	●	●	●	●							
	LARGER AIR VOLUME TYPE										●			●	●		●
<b>CONCEALED &amp; EXPOSED</b>	WALL MOUNTED TYPE		●	●		●	●		●	●			●				
	FLOOR / CEILING CONVERTIBLE TYPE						●	●	●		●	●	●		●		
	CEILING SUSPENDED TYPE					●	●		●	●			●	●		●	
<b>CEILING CASSETTE</b>	4-WAY CASSETTE TYPE [RCI-FSN3, RCI-FSKDNQ]			●		●	●		●	●			●	●		●	
	4-WAY CASSETTE COMPACT TYPE		●	●		●	●		●								
	2-WAY CASSETTE TYPE		●	●		●	●		●	●			●	●		●	
	1-WAY CASSETTE TYPE		●	●		●	●		●	●							









SET FREE mini HNRQ series

INDEX / LINE UP OVERVIEW

# LINE UP OVERVIEW

## FEATURES COMPARISON

		HIGH/MEDIUM ESP TYPE	HIGH ESP TYPE	COMPACT TYPE (AC)	COMPACT TYPE (DC)	LARGER AIR VOLUME TYPE	
<b>Model</b>		 <b>RPI-FSN3 RPI-M-FSN3</b>	 <b>RPIH-HNAUNQ</b>	 <b>RPIZ-HNATNQ</b>	 <b>RPIZ-HNDTSQ</b>	 <b>RPI-FSN2SQ</b>	
 COMFORT	Temperature Setting Rate	0.5°C/1.0°C	1.0°C	1.0°C	1.0°C	1.0°C	
	Indoor Fan Speed	4 taps	3 taps	3 taps	6 taps	3 taps	
	Louvre Direction	-	-	-	-	-	
	Individual Louvre Setting	-	-	-	-	-	
	Auto Louvre Setting	-	-	-	-	-	
	Cold Draft Prevention Availability (*1)	●	●	●	●	●	
	Dry mode Availability	●	●	●	●	●	
 POWER-SAVING	Power Saving with Motion Sensor (*2)	●	-	-	-	-	
	Outdoor Unit capacity control (*2)	Peak cut control	●	-	-	-	-
		moderate control	●	-	-	-	-
	Indoor Unit Rotation Control (*2)	Indoor Unit Address	●	-	-	-	-
		Indoor Air Temperature difference	●	-	-	-	-
Automatic Fan Operation	●	●	●	●	●		
 MENU	Quick Function	●	-	-	-	-	
	Comfort setting Control Cool Air	●	-	-	-	-	
	Daylight Saving Time	●	●	●	●	●	
	Power Consumption visualisation	●	-	-	-	-	
	Weekly Schedule Setting	●	●	●	●	●	
	Power-Saving Setting	●	-	-	-	-	
 MAINTENANCE	Dirty Filter Notice Availability	●	●	●	●	●	
	Check Menu	Sensor Condition Check	●	●	●	●	●
		Model Display (*2)	●	-	-	-	-
		Indoor/Outdoor PCB Check	●	●	●	●	●
		Alarm History Display	●	●	●	●	●
 OPTIONAL ACCESSORY	Coloured Decoration Panel availability	-	-	-	-	-	
	Motion Sensor	SOR-NEZ	-	-	-	-	
	Receiver Kit for wireless remote controller	PC-ALHZ1	PC-ALHZ1	PC-ALHZ1	PC-ALHZ1	PC-ALHZ1	
	Drain-up mechanism availability	● (*3)	DUPI-361Q	● (*3)	● (*3)	-	
	Fresh air intake accessory	-	-	-	-	-	
	Air filter	F-56/90/160LI B-56/90/160LI	KW-PP9/10Q	KW-PP5Q KW-PP6Q	KW-PP5Q KW-PP6Q	-	
	Strainer kit	-	-	-	-	-	

WALL MOUNTED TYPE	FLOOR/CEILING CONVERTIBLE TYPE	CEILING SUSPENDED TYPE	4-WAY CASSETTE TYPE		4-WAY CASSETTE COMPACT TYPE	2-WAY CASSETTE TYPE	1-WAY CASSETTE TYPE
							
<b>RPK-FSN4M</b> <b>RPK-FSNH4M</b>	<b>RPFC-FSNQ</b>	<b>RPC-FSN3</b>	<b>RCI-FSN3</b>	<b>RCI-FSKDNQ</b>	<b>RCIM-FSN4</b>	<b>RCD-FSN3</b>	<b>RCS-FSN</b>
0.5°C/1.0°C	1.0°C	0.5°C/1.0°C	0.5°C/1.0°C	0.5°C/1.0°C	0.5°C/1.0°C	0.5°C/1.0°C	0.5°C/1.0°C
4 taps	3 taps	4 taps	4 taps	4 taps	4 taps	4 taps	4 taps
7 (*5)	7 (*5)	7 (*5)	7 (*4)	7 (*4)	7 (*4)	7 (*4)	7 (*5)
-	-	-	●	●	●	●	-
-	-	-	●	●	●	●	-
●	●	●	●	●	●	●	●
●	●	●	●	●	●	●	●
-	-	●	●	●	●	●	●
●	-	●	●	●	●	●	●
●	-	●	●	●	●	●	●
●	-	●	●	●	●	●	●
●	-	●	●	●	●	●	●
●	●	●	●	●	●	●	●
●	-	●	●	●	●	●	●
●	-	●	●	●	●	●	●
●	●	●	●	●	●	●	●
●	-	●	●	●	●	●	●
●	●	●	●	●	●	●	●
●	-	●	●	●	●	●	●
●	●	●	●	●	●	●	●
●	-	●	●	●	●	●	●
●	●	●	●	●	●	●	●
-	-	-	-	-	-	● (*6)	● (*6)
-	-	SOR-NEP	P-AP160NAE	PS-MSK2	SOR-NEC	SOR-NED	SOR-NES
PC-ALHZ1	PC-ALHZ1	PC-ALHP1	PC-ALH3	PC-ALH3	PC-ALHC1	PC-ALHD1	PC-ALHS1
-	-	DUPC-63K1 DUPC-71K1 DUPC-160K1	● (*3)	● (*3)	● (*3)	● (*3)	● (*3)
-	-	-	● (*7)	-	● (*7)	● (*7)	● (*7)
-	-	-	F-71L-D1 F-160L-D1 B-160H2 F-160L-K	-	-	F-90MD-K1 F-160MD-K1 B-90HD B-160HD	-
MSF-NP63A1 MSF-NP112A1 MSF-NP36AH1	-	-	-	-	-	-	-

(\*1) This function is utilised to prevent cold discharged air at start-up of heating operation, after defrosting operation, etc. The fan speed automatically switches from Slow to Low and then to the set fan speed. The fan operation might be stopped for up to 2 minutes. At this time the louvre is fixed horizontally.

(\*2) Advanced wired remote controller PC-ARF1 needs to be connected.

(\*3) Included as standard equipment.

(\*4) 7 steps are available by individual louvre setting. 5 steps only in the operation of Cooling or Dry.

(\*5) 5 steps only in the operation of Cooling or Dry.

(\*6) 3 colours available except white (Beige, Grey and Black).

(\*7) Optional parts: Duct Adapter is available. Please consult your distributor.



## HIGH ESP TYPE (EXTERNAL STATIC PRESSURE TYPE) [RPI-FSN3]



### FEATURES AND BENEFITS



- Setback temperature control available, leading to better operation.
- GentleCool control to ensure you are not bothered by cold draft

Fits a standard drain pump with 850 mm lift

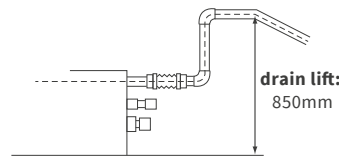

Air Inlet can be chosen from two locations

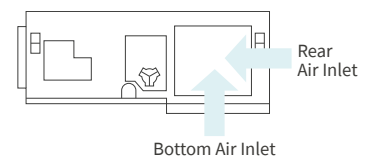

### GENERAL DATA & ACCESSORIES

Model		RPI-2.0FSN3	RPI-2.5FSN3	RPI-3.0FSN3	RPI-4.0FSN3	RPI-5.0FSN3	RPI-6.0FSN3
<b>Indoor Unit Power Supply</b>		<b>AC 1Φ, [220-240V/50Hz] [220V/60Hz]</b>					
<b>Nominal Cooling Capacity</b>	kW	5.6	7.1	8.0	11.2	14.0	16.0
<b>Nominal Heating Capacity</b>	kW	6.3	8.5	9.0	12.5	16.0	18.0
<b>Sound Pressure Level (Overall A Scale)(Hi2/Hi/Me/Lo)</b>	dB(A)	41/38/35/32	37/35/32/30	39/36/33/31	40/37/34/32	42/39/36/33	44/40/37/34
<b>Sound Power Level (Overall A Scale)(Hi2/Hi/Me/Lo)</b>	dB(A)	59/56/53/50	55/53/50/48	57/54/51/49	58/55/52/50	60/57/54/51	62/58/55/52
<b>Outer Dimensions H×W×D</b>	mm	300×700×800	300×1,050×800	300×1,050×800	300×1,400×800	300×1,400×800	300×1,400×800
<b>Net Weight</b>	kg	29	38	38	48	48	48
<b>Refrigerant</b>		R410A	R410A	R410A	R410A	R410A	R410A
<b>Indoor Fan Air Flow Rate (Hi2/Hi/Me/Lo)</b>	m <sup>3</sup> /min	14.5/13/11/9.5	18.5/16.5/14.5/12	20/17.5/15.5/13	30/26.5/23/20	33.5/29.5/26/22	36/31.5/27.5/24
	(cfm)	(512/459/388/335)	(653/582/512/423)	(706/618/547/459)	(1,059/935/812/706)	(1,182/1,041/917/776)	(1,270/1,112/970/847)
<b>External Pressure (*3)</b>	Pa	50(100-200)	50(100-200)	50(100-200)	50(100-200)	50(100-200)	50(100-200)
<b>Motor</b>	W	157	190	190	259	259	259
<b>Connections</b>	m <sup>3</sup>	Flare-Nut Connection (with Flare Nuts)					
<b>Refrigerant Piping</b>	<b>Liquid Line</b>	mm	Φ6.35	Φ9.52	Φ9.52	Φ9.52	Φ9.52
	<b>Gas Line</b>	mm	Φ12.7	Φ15.88	Φ15.88	Φ15.88	Φ15.88
	<b>Condensate Drain</b>		VP25	VP25	VP25	VP25	VP25
<b>Approximate Packing Measurement</b>	m <sup>3</sup>	0.28	0.39	0.39	0.50	0.50	0.50
<b>Receiver kit</b>		<b>PC-ALHZ1</b>					
<b>Motion Sensor</b>		<b>SOR-NEZ</b>					
<b>Condensate Drain Pump Kit</b>		<b>- (included as standard equipment)</b>					
<b>Antifungal Long-Life Filter</b>	2.0 (HP Class)	<b>F-56LI</b>					
	2.5-3.0 (HP Class)	<b>F-90LI</b>					
	4.0-6.0 (HP Class)	<b>F-160LI</b>					
<b>Filter Box for Long-Life Filter</b>	2.0 (HP Class)	<b>B-56LI</b>					
	2.5-3.0 (HP Class)	<b>B-90LI</b>					
	4.0-6.0 (HP Class)	<b>B-160LI</b>					

#### NOTES:

1. The nominal cooling capacity is the combined capacity of the Hitachi standard split system, and is based on the JIS standard B8616.

Cooling Operation Conditions		Heating Operation Conditions	
Indoor Air Inlet Temperature:	27.0°C DB 19.0°C WB	Indoor Air Inlet Temperature:	20.0°C DB 7.0°C DB
Outdoor Air Inlet Temperature:	35.0°C DB	Outdoor Air Inlet Temperature:	6.0°C WB
Piping Length:7.5 metre		Piping Length:7.5 metre	
Piping Lift:0 metre		Piping Lift:0 metre	

2. The sound pressure level is based on following conditions. 1.5 metre Beneath the Unit. With Discharge Duct (2.0 metre) and Return Duct (1.0 metre). Voltage of the power source for the indoor fan motor is 220V. The above data was measured in an anechoic chamber so that reflected sound should be taken into consideration in the field.

3. The data for external pressure (\*3) indicates "Standard Pressure Setting (High Pressure Setting1 - High Pressure Setting2)" values when a filter is not used. The sound pressure level is based on the Standard Pressure Setting.



## MEDIUM ESP TYPE (EXTERNAL STATIC PRESSURE TYPE)



### FEATURES AND BENEFITS



- Setback temperature control available, leading to better operation.
- GentleCool control to ensure you are not bothered by cold draft

Fits a standard drain pump with 850 mm lift

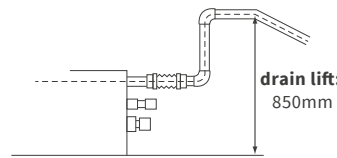

Air Inlet can be chosen from two locations

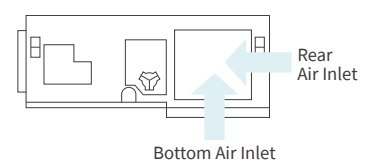

### GENERAL DATA & ACCESSORIES

Model	RPIM-0.8FSN3	RPIM-1.0FSN3	RPIM-1.5FSN3	RPIM-2.0FSN3	RPIM-2.5FSN3	RPIM-3.0FSN3	RPIM-4.0FSN3	RPIM-5.0FSN3	RPIM-6.0FSN3		
<b>Indoor Unit Power Supply</b>	AC 1Φ, [220-240V/50Hz] [220V/60Hz]										
<b>Nominal Cooling Capacity</b>	kW	2.2	2.8	4.0	5.6	7.1	8.0	11.2	14.0	16.0	
<b>Nominal Heating Capacity</b>	kW	2.5	3.2	4.8	6.3	8.5	9.0	12.5	16.0	18.0	
<b>Sound Pressure Level (Overall A Scale)(Hi2/Hi/Me/Lo)</b>	dB(A)	32/30/28/27	33/31/29/28	38/35/32/30	40/37/34/31	37/35/33/31	38/36/33/31	40/38/35/32	42/39/36/34	43/40/37/34	
<b>Sound Power Level (Overall A Scale)(Hi2/Hi/Me/Lo)</b>	dB(A)	50/48/46/45	51/49/47/46	56/53/50/48	58/55/52/49	55/53/51/49	56/54/51/49	58/56/53/50	60/57/54/52	61/58/55/52	
<b>Outer Dimensions</b>	H×W×D	250×700×800	250×700×800	250×700×800	250×700×800	250×1,050×800	250×1,050×800	250×1,400×800	250×1,400×800	250×1,400×800	
<b>Net Weight</b>	kg	26	26	27	27	36	36	44	44	44	
<b>Refrigerant</b>		R410A	R410A	R410A	R410A	R410A	R410A	R410A	R410A	R410A	
<b>Indoor Fan</b>	<b>Air Flow Rate (Hi2/Hi/Me/Lo)</b>	<b>m<sup>3</sup>/min (cfm)</b>	8.5/7.5/	9.5/8.5/	13/11.5/	14.5/13/	18.5/16.5/	20/17.5/	30/26.5/	33.5/29.5/	36/31.5/
			(300/265/229/194)	(335/300/265/229)	(459/406/353/300)	(512/459/388/335)	(653/582/494/423)	(706/618/547/459)	(1,059/935/812/706)	(1,182/1,041/917/776)	(1270/1,112/970/847)
<b>External Pressure (*3)</b>	<b>Pa</b>	50(100-150)	50(100-150)	50(100-150)	50(100-150)	50(100-150)	50(100-150)	50(100-150)	50(100-150)	50(100-150)	
<b>Motor</b>	<b>W</b>	157	157	157	157	190	190	259	259	259	
<b>Connections</b>		Flare-Nut Connection (with Flare Nuts)									
<b>Refrigerant Piping</b>	<b>Liquid Line</b>	<b>mm</b>	Φ6.35	Φ6.35	Φ6.35	Φ6.35	Φ9.52	Φ9.52	Φ9.52	Φ9.52	
	<b>Gas Line</b>	<b>mm</b>	Φ12.7	Φ12.7	Φ12.7	Φ12.7	Φ15.88	Φ15.88	Φ15.88	Φ15.88	
	<b>Condensate Drain</b>		VP25	VP25	VP25	VP25	VP25	VP25	VP25	VP25	
<b>Approximate Packing Measurement</b>	<b>m<sup>3</sup></b>	0.24	0.24	0.24	0.24	0.33	0.33	0.42	0.42	0.42	
<b>Receiver kit</b>		<b>PC-ALHZ1</b>			<b>0.8-2.0 (HP Class)</b>			<b>B-56LI</b>			
<b>Motion Sensor</b>		<b>SOR-NEZ</b>			<b>2.5-3.0 (HP Class)</b>			<b>B-90LI</b>			
<b>Condensate Drain Pump Kit</b>		<b>-(included as standard equipment)</b>									
<b>Antifungal Long-Life Filter</b>		<b>0.8-2.0 (HP Class)</b>			<b>F-56LI</b>						
		<b>2.5-3.0 (HP Class)</b>			<b>F-90LI</b>						
		<b>4.0-6.0 (HP Class)</b>			<b>F-160LI</b>						

NOTES:

- The nominal cooling capacity is the combined capacity of the Hitachi standard split system, and is based on the JIS standard B8616.
 

Cooling Operation Conditions	Heating Operation Conditions
Indoor Air Inlet Temperature: 27.0°C DB	Indoor Air Inlet Temperature: 20.0°C DB
19.0°C WB	Outdoor Air Inlet Temperature: 7.0°C DB)
Outdoor Air Inlet Temperature: 35.0°C DB	6.0°C WB
Piping Length:7.5 metre	Piping Length:7.5 metre
Piping Lift:0 metre	Piping Lift:0 metre
- The sound pressure level is based on following conditions. 1.5 metre Beneath the Unit. With Discharge Duct (2.0 metre) and Return Duct (1.0 metre). Voltage of the power source for the indoor fan motor is 220V. The above data was measured in an anechoic chamber so that reflected sound should be taken into consideration in the field.
- The data for external pressure (\*3) indicates "Standard Pressure Setting (High Pressure Setting1 - High Pressure Setting2)" values when a filter is not used. The sound pressure level is based on the Standard Pressure Setting.

SET FREE mini HNRQ series

DUCTED



## HIGH ESP TYPE (EXTERNAL STATIC PRESSURE TYPE) [RPIH-HNAUNQ]



### FEATURES AND BENEFITS



- High ESP (90/120Pa)
- Space saving design thanks to a height of only 300mm

Flexible installation options allow for multiple configurations

L-shaped space

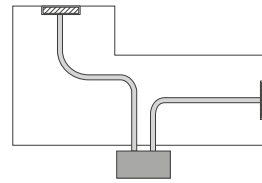

U-shaped space

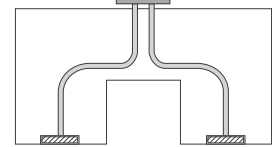

### GENERAL DATA & ACCESSORIES

Model			RPIH-3.0HNAUNQ	RPIH-3.3HNAUNQ	RPIH-4.0HNAUNQ	RPIH-5.0HNAUNQ	RPIH-6.0HNAUNQ
<b>Indoor Unit Power Supply</b>			<b>AC 1Φ, [220-240V/50Hz]</b>				
Nominal Capacity	Cooling	kW	8.4	9.0	11.2	14.2	16.0
	Heating	kW	9.6	10.0	13.0	16.3	18.0
Sound Pressure Level	(Hi/Me/Lo)	dB(A)	42/39/34	42/39/34	43/39/34	44/41/37	48/42/37
Outer Dimension	H×W×D	mm	300×1,175×800	300×1,175×800	300×1,175×800	300×1,475×800	300×1,475×800
Net Weight		kg	45	45	45	53	54
Refrigerant			R410A	R410A	R410A	R410A	R410A
Indoor Fan Air Flow Rate	(Hi/Me/Lo)	m <sup>3</sup> /min	30/28/23	30/28/23	30/28/23	35.5/32/27	41/33/26
External Static Pressure (*3)		Pa	120(90)	120(90)	120(90)	120(90)	120(90)
Connections			Flare-Nut Connection (with Flare Nuts)				
Refrigerant Piping Diameter	Liquid Line	mm	Φ9.52	Φ9.52	Φ9.52	Φ9.52	Φ9.52
	Gas Line	mm	Φ15.88	Φ15.88	Φ15.88	Φ15.88	Φ15.88
Condensate Drain			VP25	VP25	VP25	VP25	VP25
Approximate Packing Volume		m <sup>3</sup>	0.40	0.40	0.40	0.49	0.49

Receiver Kit		<b>PC-ALHZ1</b>
Condensate Drain Pump Kit		<b>DUPI-361Q</b>
Air filter	3.0-4.0 (HP class)	<b>KW-PP9Q</b>
	5.0-6.0 (HP class)	<b>KW-PP10Q</b>

#### NOTES:

- The cooling capacities above show the maximum capacities when the outdoor and indoor temperature are under the following conditions.
 

Cooling Operation Conditions		Heating Operation Conditions	
Indoor Air Inlet Temperature:	27.0°C DB	Indoor Air Inlet Temperature:	20.0°C DB
	19.0°C WB	Outdoor Air Inlet Temperature:	7.0°C DB
Outdoor Air Inlet Temperature:	35.0°C DB		6.0°C WB
Piping Length:	7.5 metre	Piping Length:	7.5 metre
Piping Lift:	0 metre	Piping Lift:	0 metre
- The sound pressure level is based on following conditions.
  - 1.4 metre Beneath the unit.
  - With Discharge Duct (2.0 metre) and Return Duct (1.0 metre).
  - Voltage of the power source for the indoor fan motor is 220V.
  - (In case of the power source of 240V, the sound pressure level increases by about 1~2dB(A).)
  - The above data was measured in an anechoic chamber so that reflected sound should be taken into consideration in the field.
- The data for external pressure (\*3) indicates "Standard Pressure Setting values when a filter is not used.



## COMPACT TYPE (AC MOTOR TYPE)



### FEATURES AND BENEFITS



- Ideal for installation over the closet or windows thanks to the up to the compactness with 192mm height
- Drain-pump with 900mm lift as standard optional part
- Quiet operation level (as low as 20dB(A))
- Fan air flow rate up to 6 taps (DC motor model only)

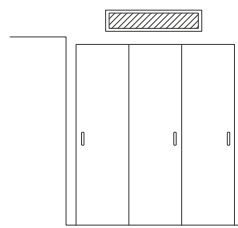

Over the closet

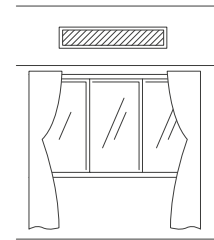

In dropped ceiling, over window

### GENERAL DATA & ACCESSORIES

Model (AC MOTOR)			RPIZ-0.8HNATNQ	RPIZ-1.0HNATNQ	RPIZ-1.3HNATNQ	RPIZ-1.5HNATNQ	RPIZ-1.8HNATNQ	RPIZ-2.0HNATNQ	RPIZ-2.3HNATNQ	RPIZ-2.5HNATNQ
<b>Indoor Unit Power Supply</b>			<b>AC 1Φ, [220-240V/50Hz]</b>							
Nominal Capacity	Cooling	kW	2.2	2.8	3.6	4.0	5.0	5.6	6.3	7.1
	Heating	kW	2.5	3.2	4.0	4.5	5.6	6.3	7.1	8.0
Sound Pressure Level	(Hi/Me/Lo)	dB(A)	30/23/20	30/23/20	34/25/22	32.5/26/23	34/26/25	34/26/25	37/29/27	37/29/27
Outer Dimension	H×W×D	mm	192×700×447	192×700×447	192×700×447	192×910×447	192×1,180×447	192×1,180×447	192×1,180×447	192×1,180×447
Net Weight		kg	17	17	17	21	27	27	28	28
Refrigerant			R410A	R410A	R410A	R410A	R410A	R410A	R410A	R410A
Indoor Fan Air Flow Rate	(Hi/Me/Lo)	m <sup>3</sup> /min	9.5/6.5/5.5	9.5/6.5/5.5	9.5/6.5/5.5	10/7/6	15/10/9	15/10/9	17/10/9	17/10/9
External Static Pressure (*3)		Pa	10(30)	10(30)	10(30)	10(30)	10(30)	10(30)	10(30)	10(30)
Connections			Flare-Nut Connection (with Flare Nuts)							
Refrigerant Piping Diameter	Liquid Line	mm	Φ6.35	Φ6.35	Φ6.35	Φ6.35	Φ6.35	Φ6.35	Φ9.52	Φ9.52
	Gas Line	mm	Φ12.70	Φ12.70	Φ12.70	Φ12.70	Φ15.88	Φ15.88	Φ15.88	Φ15.88
Condensate Drain			VP25	VP25	VP25	VP25	VP25	VP25	VP25	VP25
Approximate Packing Volume		m <sup>3</sup>	0.142	0.142	0.142	0.15	0.18	0.18	0.18	0.18

Receiver kit		<b>PC-ALHZ1</b>
Condensate Drain Pump Kit		<b>-(included as standard equipment)</b>
Air filter	0.8-1.5 (HP Class)	<b>KW-PP5Q</b>
	1.8-2.5 (HP Class)	<b>KW-PP6Q</b>

NOTES:

- The cooling capacities above show the maximum capacities when the outdoor and indoor temperature are under the following conditions.
 

Cooling Operation Conditions Indoor Air Inlet Temperature: 27.0°C DB 19.0°C WB Outdoor Air Inlet Temperature: 35.0°C DB Piping Length: 7.5 metre Piping Lift: 0 metre	Heating Operation Conditions Indoor Air Inlet Temperature: 20.0°C DB Outdoor Air Inlet Temperature: 7.0°C DB 6.0°C WB Piping Length: 7.5 metre Piping Lift: 0 metre
--------------------------------------------------------------------------------------------------------------------------------------------------------------------------------------	------------------------------------------------------------------------------------------------------------------------------------------------------------------------------------
- The sound pressure level is based on following conditions.
  - 1.4 metre Beneath the unit.
  - With Discharge Duct (2.0 metre) and Return Duct (1.0 metre).
  - Voltage of the power source for the indoor fan motor is 220V.
  - (In case of the power source of 240V, the sound pressure level increases by about 1-2dB(A).)
  - The above data was measured in an anechoic chamber so that reflected sound should be taken into consideration in the field.
- The data for external pressure (\*3) indicates "Standard Pressure Setting values when a filter is not used.



## COMPACT TYPE (DC MOTOR TYPE)



### FEATURES AND BENEFITS



- Ideal for installation over the closet or windows thanks to the up to the compactness with 192mm height
- Drain-pump with 900mm lift as standard optional part
- Quiet operation level (as low as 20dB(A))
- Fan air flow rate up to 6 taps (DC motor model only)

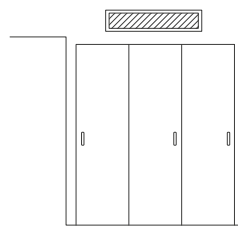

Over the closet

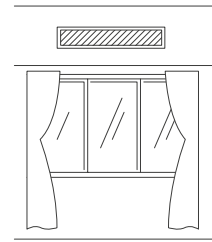

In dropped ceiling, over window

### GENERAL DATA & ACCESSORIES

Model (DC MOTOR)			RPIZ-0.8HNDTSQ	RPIZ-1.0HNDTSQ	RPIZ-1.3HNDTSQ	RPIZ-1.5HNDTSQ	RPIZ-1.8HNDTSQ	RPIZ-2.0HNDTSQ	RPIZ-2.3HNDTSQ	RPIZ-2.5HNDTSQ
<b>Indoor Unit Power Supply</b>			<b>AC 1Φ, [220-240V/50Hz] [220V/60Hz]</b>							
Nominal Capacity	Cooling	kW	2.2	2.8	3.6	4.0	5.0	5.6	6.3	7.1
	Heating	kW	2.5	3.2	4.0	4.5	5.6	6.3	7.1	8.0
Sound Pressure Level	(6 taps)	dB(A)	33/31/28/	33/31/28/	33/31/28/	31/30/28/	36/33.5/31/	36/33.5/31/	36/33.5/31/	36/33.5/31/
			25/23.5/22.5	25/23.5/22.5	25/23.5/22.5	25/22/20	28/24.5/22.5	28/24.5/22.5	28/24.5/22.5	28/24.5/22.5
Outer Dimension	H×W×D	mm	192×700×447	192×700×447	192×700×447	192×910×447	192×1,180×447	192×1,180×447	192×1,180×447	192×1,180×447
Net Weight		kg	17	17	17	20	24	24	24	24
Refrigerant			R410A	R410A	R410A	R410A	R410A	R410A	R410A	R410A
Indoor Fan Air Flow Rate	(6 taps)	m <sup>3</sup> /min	8.5/8/7/	8.5/8/7/	8.5/8/7/	10/9/8/	16.5/15/13/	16.5/15/13/	16.5/15/13/	16.5/15/13/
			6/5.5/5	6/5.5/5	6/5.5/5	7.5/6.5/6	12/10/9	12/10/9	12/10/9	12/10/9
External Static Pressure (*3)		Pa	10(0-10-30)	10(0-10-30)	10(0-10-30)	10(0-10-30)	10(0-10-50)	10(0-10-50)	10(0-10-50)	10(0-10-50)
Connections			Flare-Nut Connection (with Flare Nuts)							
Refrigerant Piping Diameter	Liquid Line	mm	Φ6.35	Φ6.35	Φ6.35	Φ6.35	Φ6.35	Φ6.35	Φ9.52	Φ9.52
	Gas Line	mm	Φ12.70	Φ12.70	Φ12.70	Φ12.70	Φ15.88	Φ15.88	Φ15.88	Φ15.88
Condensate Drain			VP25	VP25	VP25	VP25	VP25	VP25	VP25	VP25
Approximate Packing Volume		m <sup>3</sup>	0.142	0.142	0.142	0.15	0.18	0.18	0.18	0.18

Receiver kit	<b>PC-ALH21</b>
Condensate Drain Pump Kit	<b>-(included as standard equipment)</b>
Air filter	<b>0.8-1.5 (HP Class) KW-PP5Q</b>
	<b>1.8-2.5 (HP Class) KW-PP6Q</b>

#### NOTES:

1. The cooling capacities above show the maximum capacities when the outdoor and indoor temperature are under the following conditions.

Cooling Operation Conditions		Heating Operation Conditions	
Indoor Air Inlet Temperature:	27.0°C DB	Indoor Air Inlet Temperature:	20.0°C DB
	19.0°C WB	Outdoor Air Inlet Temperature:	7.0°C DB
Outdoor Air Inlet Temperature:	35.0°C DB		6.0°C WB
Piping Length:	7.5 metre	Piping Length:	7.5 metre
Piping Lift:	0 metre	Piping Lift:	0 metre

2. The sound pressure level is based on following conditions.

- 1.4 metre Beneath the unit.
- With Discharge Duct (2.0 metre) and Return Duct (1.0 metre).
- Voltage of the power source for the indoor fan motor is 220V.
- (In case of the power source of 240V, the sound pressure level increases by about 1~2dB(A).)
- The above data was measured in an anechoic chamber so that reflected sound should be taken into consideration in the field.

3. The data for external pressure (\*3) indicates "Standard Pressure Setting values when a filter is not used.





## LARGER AIR VOLUME TYPE



### FEATURES AND BENEFITS



- Two external static pressure settings for better flexibility
- High external static pressure: Up to 120Pa
- Suitable for air distribution for multiple zone

Flexible installation options allow for multiple configurations

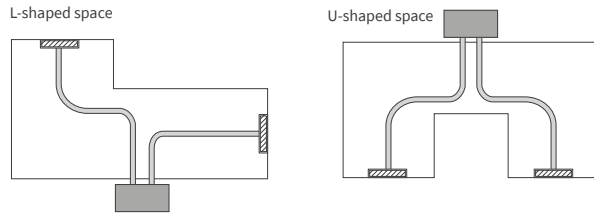

### GENERAL DATA & ACCESSORIES

Model	RPI-3.0FSN2SQ		RPI-4.0FSN2SQ		RPI-5.0FSN2SQ		RPI-6.0FSN2SQ	
<b>Indoor Unit Power Supply</b>	AC 1 Φ, [220-240V/50Hz]							
<b>Nominal Cooling Capacity</b>	kW	8.0	11.2	14.0	16.0			
<b>Nominal Heating Capacity</b>	kW	9.0	12.5	16.0	18.0			
<b>Sound Pressure Level (Overall A Scale) (Hi/Me/Lo)</b>	<b>High Pressure Setting</b>	dB(A)	46/44/40	48/45/41	49/46/43	53/49/45		
	<b>Standard Pressure Setting</b>	dB(A)	45/43/39	47/44/40	48/45/42	52/48/44		
<b>Outer Dimensions</b>	H×W×D	mm	350×1,076×800	350×1,076×800	350×1,300×800	350×1,300×800		
<b>Net Weight</b>	kg	52	57	61	63			
<b>Refrigerant</b>		R410A	R410A	R410A	R410A			
<b>Indoor Fan</b>	<b>High Pressure Setting</b>	m <sup>3</sup> /min (l/s)	29/26/20 (483/433/333)	36/33/25 (600/550/417)	47/43/34 (783/717/567)	56/50/40 (933/833/667)		
	<b>Standard Pressure Setting</b>	m <sup>3</sup> /min (l/s)	29/26/20 (483/433/333)	36/29/25 (600/483/417)	47/39/36 (783/650/600)	56/48/42 (933/800/700)		
<b>Air Flow Rate (Hi/Me/Lo)</b>								
<b>External Pressure (*1)</b>	Pa	120 (70)	120 (70)	120 (70)	120 (70)			
<b>Motor Output</b>	W	250	300	420	550			
<b>Connections</b>	Flare-Nut Connection (with Flare Nuts)							
<b>Refrigerant Piping</b>	<b>Liquid Line</b>	mm	Φ9.52	Φ9.52	Φ9.52	Φ9.52		
	<b>Gas Line</b>	mm	Φ15.88	Φ15.88	Φ15.88	Φ15.88		
	<b>Condensate Drain</b>		VP25	VP25	VP25	VP25		
<b>Approximate Packing Measurement</b>	m <sup>3</sup>	0.49	0.49	0.57	0.57			

**Receiver kit** **PC-ALH21**

**NOTES:**

1. The cooling and heating capacities above show the maximum capacities when the outdoor and indoor temperature are under the following conditions.

<b>Cooling Operation Conditions</b>		<b>Heating Operation Conditions</b>	
Indoor Air Inlet Temperature:	27.0°C DB 19.0°C WB	Indoor Air Inlet Temperature:	20.0°C DB
Outdoor Air Inlet Temperature:	35.0°C DB	Outdoor Air Inlet Temperature:	7.0°C DB 6.0°C WB
Piping Length:	7.5 metre	Piping Length:	7.5 metre
Piping Lift:	0 metre	Piping Lift:	0 metre

2. The sound pressure level is based on following conditions. 1.5 metre Beneath the Unit. With Discharge Duct (2.0 metre) and Return Duct (1.0 metre). Voltage of the power source for the indoor fan motor is 220V. In case of the power source of 240V, the sound pressure level increases by about 1 or 2dB(A). The data in the table above was measured in an anechoic chamber so that reflected sound should be taken into consideration in the field.

3. The data for external pressure (\*1) indicates "High Pressure Setting (Standard Pressure Setting)" values when a filter is not used. The sound pressure level is based on the Standard Pressure Setting.



## WALL MOUNTED TYPE



### FEATURES AND BENEFITS



**Simple installation procedure**

Refrigerant piping can be connected from the rear, base, or left of the unit, providing much greater flexibility for piping and selection of installation sites.



**To ensure quieter environment**

"External Expansion Valve Type" are suitable for hotel rooms or residences where background noise is lower. To minimise the continuous refrigerant running noise, You can install the expansion valve away from the unit.



**Easy maintenance**

Front flat panel keeps the unit from dust and facilitates maintenance work. The front grille hinges open easily—no tools are needed to gain quick access to the filter. The filter can be removed and cleaned as required.

### GENERAL DATA & ACCESSORIES

Type		Expansion Valve built-in type							External Expansion Valve type		
Model		RPK-0.8 FSN4M	RPK-1.0 FSN4M	RPK-1.5 FSN4M	RPK-2.0 FSN4M	RPK-2.5 FSN4M	RPK-3.0 FSN4M	RPK-4.0 FSN4M	RPK-0.8 FSNH4M	RPK-1.0 FSNH4M	RPK-1.5 FSNH4M
<b>Indoor Unit Power Supply</b>		AC 1Φ, [220-240V/50Hz] [220V/60Hz]							AC 1Φ, [220-240V/50Hz] [220V/60Hz]		
<b>Nominal Capacity</b>	Cooling	2.2	2.8	4.0	5.6	7.1	8.0	11.2	2.2	2.8	4.0
	Heating	2.5	3.2	4.8	6.3	8.5	9.0	12.5	2.5	3.2	4.8
<b>Sound Pressure Level</b>	(Hi2/Hi/Me/Lo)	39/35/32/30	39/35/32/30	46/40/36/33	40/37/34/31	45/42/38/35	47/44/40/35	51/48/44/39	39/35/32/30	39/35/32/30	46/40/36/33
<b>Colour</b>		White							White		
<b>Outer Dimension (H×W×D)</b>	mm	300×790×230	300×790×230	300×900×230	300×1,100×260	300×1,100×260	300×1,100×260	300×1,100×260	300×790×230	300×790×230	300×900×230
<b>Net Weight</b>	kg	10	10	11	14.5	15	15	15	10	10	11
<b>Refrigerant</b>		R410A	R410A	R410A	R410A	R410A	R410A	R410A	R410A	R410A	R410A
<b>Indoor Fan Air Flow Rate</b>	(Hi2/Hi/Me/Lo)	10/8/7/6.5	10/8/7/6.5	14/11/9/7.5	14.5/13/11/9.5	18.5/16.5/14/12	20/17.5/15.5/12.5	23/20/17.5/14.5	10/8/7/6.5	10/8/7/6.5	14/11/9/7.5
	<b>Motor</b>	38	38	38	38	38	38	38	38	38	38
<b>Connections</b>		Flare-Nut Connection (with Flare Nuts)							Flare-Nut Connection (with Flare Nuts)		
<b>Refrigerant Piping Diameter</b>	Liquid Line	Φ6.35	Φ6.35	Φ6.35	Φ6.35	Φ9.52	Φ9.52	Φ9.52	Φ6.35	Φ6.35	Φ6.35
	Gas Line	Φ12.7	Φ12.7	Φ12.7	Φ12.7	Φ15.88	Φ15.88	Φ15.88	Φ12.7	Φ12.7	Φ12.7
<b>Condensate Drain</b>		VP16	VP16	VP16	VP16	VP16	VP16	VP16	VP16	VP16	VP16
<b>Approximate Packing Volume</b>	m <sup>3</sup>	0.09	0.09	0.11	0.14	0.14	0.14	0.14	0.09	0.09	0.11
<b>Accessory included</b>		Wall Mounting Bracket							Wall Mounting Bracket		

<b>Receiver kit</b>	<b>PC-ALHZ1</b>
<b>Strainer kit</b>	<b>MSF-NP63A1</b>
<b>External Expansion Valve Kit</b>	<b>EV-1.5N1</b>

#### NOTES:

- The cooling and heating capacities above show the maximum capacities when the outdoor and indoor temperature are under the following conditions.
 

Cooling Operation Conditions		Heating Operation Conditions	
Indoor Air Inlet Temperature:	27.0°C DB	Indoor Air Inlet Temperature:	20.0°C DB
	19.0°C WB	Outdoor Air Inlet Temperature:	7.0°C DB
Outdoor Air Inlet Temperature:	35.0°C DB		6.0°C WB
Piping Length: 7.5 metre		Piping Length: 7.5 metre	
Piping Lift: 0 metre		Piping Lift: 0 metre	
- The sound pressure level is based on following conditions.
  - 1.0 metre Beneath the Unit.
  - 1.0 metre from Discharge Grille.

The above data was measured in an anechoic chamber so that reflected sound should be taken into consideration in the field. When bottom air inlet is adopted, sound pressure will increase according to factors such as installation mode and the room structure.
- RPK-0.6FSN4M & RPK-0.6FSN4HM cannot be connected to HNRQ series. Please refer to the technical catalogue for the details.

#### STRAINER KIT

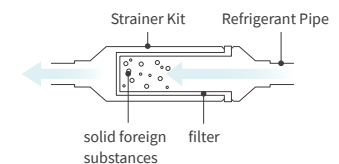

A strainer kit ensures that solid foreign substances, like small particles of metal, are caught before they enter the electric expansion valves of a wall-mounted indoor unit. Without the strainer kit's filter, these particles may prevent the valves from being fully sealed, creating a risk of explosive condensation when the unit becomes active.



## FLOOR/CEILING CONVERTIBLE TYPE



### FEATURES AND BENEFITS



#### Adapts to both floor and ceiling

##### [CEILING USE]

Supplies air to a wide area.  
High ceiling use capability.

##### [FLOOR USE]

Smaller footprint: Only 230mm in depth.  
Suitable for installation beneath a window thanks to the 680mm height.



#### New air-intake design

Equipped with air-intakes, the unit connects with ventilations such as a Total Heat Exchanger using a duct, providing better interior air quality.

### GENERAL DATA & ACCESSORIES

Model			RPFC-1.8FSNQ	RPFC-2.0FSNQ	RPFC-2.3FSNQ	RPFC-2.5FSNQ	RPFC-3.0FSNQ	RPFC-3.3FSNQ	RPFC-4.0FSNQ	RPFC-5.0FSNQ
Indoor Unit Power Supply			AC 1Φ, [220-240V/50Hz] [220V/60Hz]							
Nominal Capacity	Cooling	kW	5.0	5.6	6.3	7.1	8.4	9.0	11.2	14.2
	Heating	kW	5.6	6.5	7.5	8.5	9.6	10.0	13.0	16.3
Sound Pressure Level	Ceiling Mode	dB(A)	39/35/30	39/35/30	45/41/37	45/41/37	43/39/34	45/40/36	51/46/40	50/46/42
	Floor Mode	dB(A)	43/38/35	43/38/35	48/44/40	48/44/40	46/41/37	48/43/39	54/49/43	55/50/46
Outer Dimension	(H×W×D)	mm	230×990×680	230×990×680	230×990×680	230×990×680	230×1,285×680	230×1,285×680	230×1,285×680	230×1,580×680
Net Weight		kg	31	31	32	32	39	40	41	47
Refrigerant			R410A	R410A	R410A	R410A	R410A	R410A	R410A	R410A
Indoor Fan Air Flow Rate	(Hi/Me/Lo)	m <sup>3</sup> /h	780/660/540	780/660/540	966/840/678	966/840/678	1,092/912/732	1,164/978/798	1,488/1,230/978	1,980/1,680/1,380
Connections			Flare-Nut Connection (with Flare Nuts)							
Refrigerant Piping Diameter	Liquid Line	mm	Φ6.35	Φ6.35	Φ9.52	Φ9.52	Φ9.52	Φ9.52	Φ9.52	Φ9.52
	Gas Line	mm	Φ15.88	Φ15.88	Φ15.88	Φ15.88	Φ15.88	Φ15.88	Φ15.88	Φ15.88
Condensate Drain			VP25	VP25	VP25	VP25	VP25	VP25	VP25	VP25
Approximate Packing Volume		m <sup>3</sup>	0.31	0.31	0.31	0.31	0.40	0.40	0.40	0.48

Receiver kit **PC-ALHZ1**

#### NOTES:

1. The cooling and heating capacities above show the maximum capacities when the outdoor and indoor temperature are under the following conditions.

##### Cooling Operation Conditions

Indoor Air Inlet Temperature: 27.0°C DB  
19.0°C WB  
Outdoor Air Inlet Temperature: 35.0°C DB

Piping Length: 7.5 metre  
Piping Lift: 0 metre

##### Heating Operation Conditions

Indoor Air Inlet Temperature: 20.0°C DB  
Outdoor Air Inlet Temperature: 7.0°C DB  
6.0°C WB

Piping Length: 7.5 metre  
Piping Lift: 0 metre

2. The sound pressure level is based on following conditions.

1.0 metre Beneath the unit.  
1.0 metre from Discharge grille.

The above data was measured in an anechoic chamber so that reflected sound should be taken into consideration in the field.

When bottom air inlet is adopted, sound pressure will increase according to factors such as installation mode and the room structure.



## CEILING SUSPENDED TYPE



### FEATURES AND BENEFITS

#### Adaptability



1) Wide Detection area of motion sensor (SOR-NEP)

(Optional part) to achieve better energy-saving



2) Auto louvre

Softens the discomfort by temperature irregularity and cold draft

#### Design Flexibility



Suitable for high ceiling space

Thanks to 5.6m cooling air blow down

### GENERAL DATA & ACCESSORIES

Model	RPC-1.5FSN3	RPC-2.0FSN3	RPC-2.5FSN3	RPC-3.0FSN3	RPC-4.0FSN3	RPC-5.0FSN3	RPC-6.0FSN3		
<b>Indoor Unit Power Supply</b>	AC 1Φ, [220-240V/50Hz] [220V/60Hz]								
<b>Nominal Capacity</b>	Cooling	kW	4.0	5.6	7.1	8.0	11.2	14.0	16.0
	Heating	kW	4.8	6.3	8.5	9.0	12.5	16.0	18.0
<b>Sound Pressure Level</b>	(Hi2/Hi/Me/Lo)	dB(A)	37/35/31/28	38/35/31/28	38/35/31/28	40/37/33/29	44/42/37/32	48/45/41/35	49/47/42/36
<b>Colour</b>	Neutral White								
<b>Outer Dimension (H×W×D)</b>	mm	235×960×690	235×960×690	235×1,270×690	235×1,270×690	235×1,580×690	235×1,580×690	235×1,580×690	
<b>Net Weight</b>	kg	26	27	35	35	41	41	41	
<b>Refrigerant</b>	R410A								
<b>Indoor Fan Air Flow Rate</b>	(Hi2/Hi/Me/Lo)	m <sup>3</sup> /min	15/13/11/9	15/13/11/9	19/16.5/14/11.5	21/18.5/15.5/12.5	30/26.5/22/17	35/31/25.5/20	37/32.5/27/21
<b>Connections</b>	Flare-Nut Connection (with Flare Nuts)								
<b>Refrigerant Piping Diameter</b>	Liquid Line	mm	Φ6.35	Φ6.35	Φ9.52	Φ9.52	Φ9.52	Φ9.52	Φ9.52
	Gas Line	mm	Φ12.7	Φ15.88	Φ15.88	Φ15.88	Φ15.88	Φ15.88	Φ15.88
<b>Condensate Drain</b>	VP20								
<b>Approximate Packing Volume</b>	m <sup>3</sup>	0.23	0.23	0.31	0.31	0.38	0.38	0.38	
<b>Receiver kit</b>	PC-ALHP1								
<b>Motion Sensor</b>	SOR-NEP								
<b>Condensate Drain Pump Kit</b>	1.5 (HP Class)	DUPC-63K1							
	2.0 (HP Class)	DUPC-71K1							
	2.5-6.0 (HP Class)	DUPC-160K1							

#### NOTES:

1. The cooling and heating capacities above show the maximum capacities when the outdoor and indoor temperature are under the following conditions.

Cooling Operation Conditions

Indoor Air Inlet Temperature: 27.0°C DB

Outdoor Air Inlet Temperature: 19.0°C WB

35.0°C DB

Piping Length: 7.5 metre

Piping Lift: 0 metre

Heating Operation Conditions

Indoor Air Inlet Temperature: 20.0°C DB

Outdoor Air Inlet Temperature: 7.0°C DB

6.0°C WB

Piping Length: 7.5 metre

Piping Lift: 0 metre

2. The sound pressure level is based on following conditions.

1.0 metre Beneath the unit.

1.0 metre from Discharge grille.

The above data was measured in an anechoic chamber so that reflected sound should be taken into consideration in the field.

When bottom air inlet is adopted, sound pressure will increase according to factors such as installation mode and the room structure.



## 4-WAY CASSETTE TYPE [RCI-FSN3]



### FEATURES AND BENEFITS

#### ★ Adaptability

- 1) Wide Detection area of motion sensor
- 2) Control air flow with individual four-way louvres

#### ♡ Comfort

- Setback temperature control available, leading to better operation.
- GentleCool control to ensure you are not bothered by cold draft

#### ✏ Design Flexibility

- 1) Used in both narrow ceiling cavity, and with high ceiling
- 2) Standard drain pump with 850mm lift
- 3) Round ducts can be attached directly
- 4) The height of the space for installing the unit can be fine-tuned

### GENERAL DATA & ACCESSORIES

Model			RCI-1.0FSN3	RCI-1.5FSN3	RCI-2.0FSN3	RCI-2.5FSN3	RCI-3.0FSN3	RCI-4.0FSN3	RCI-5.0FSN3	RCI-6.0FSN3
Indoor Unit Power Supply			AC 1Φ, [220-240V/50Hz] [220V/60Hz]							
Nominal Capacity	Cooling	kW	2.8	4.0	5.6	7.1	8.0	11.2	14.0	16.0
	Heating	kW	3.2	4.8	6.3	8.5	9.0	12.5	16.0	18.0
Sound Pressure Level	(Hi2/Hi/Me/Lo)	dB(A)	33/30/28/27	35/31/30/27	37/32/30/27	42/36/32/28	42/36/32/28	48/43/39/33	48/45/40/35	48/46/41/37
Outer Dimension	(H×W×D)	mm	248×840×840	248×840×840	248×840×840	248×840×840	298×840×840	298×840×840	298×840×840	298×840×840
Net Weight		kg	20	21	21	22	26	26	26	26
Refrigerant			R410A	R410A	R410A	R410A	R410A	R410A	R410A	R410A
Indoor Fan Air Flow Rate	(Hi2/Hi/Me/Lo)	m <sup>3</sup> /min	15/13/11/9	21/17/14/11	22/17/14/11	27/23/18/14	27/23/18/14	37/31/24/20	37/33/26/21	37/35/28/22
Connections			Flare-Nut Connection (with flare Nuts)							
Refrigerant Piping Diameter	Liquid Line	mm	Φ6.35	Φ6.35	Φ6.35	Φ9.52	Φ9.52	Φ9.52	Φ9.52	Φ9.52
	Gas Line	mm	Φ12.7	Φ12.7	Φ15.88	Φ15.88	Φ15.88	Φ15.88	Φ15.88	Φ15.88
Condensate Drain			VP25	VP25	VP25	VP25	VP25	VP25	VP25	VP25
Approximate Packing Volume		m <sup>3</sup>	0.21	0.21	0.21	0.21	0.25	0.25	0.25	0.25

Adaptable Panel Model	P-AP160NA1 (without Motion Sensor)	P-AP160NAE (with Motion Sensor)
Colour	Neutral White	
Outer Dimension (H×W×D)	mm	37×950×950
Net Weight	kg	6.5
Approximate Packing Volume	m <sup>3</sup>	0.10

Decoration panel	With Motion Sensor	P-AP160NAE	3-Way Outlet Parts Set	PI-160LS1
	Without Motion Sensor	P-AP160NA1	T-Pipe Connection Kit	TKCI-160K
Receiver kit		PC-ALH3	Kit for Deodorant Filter & Filter set	1.0-2.5 (HP Class) F-71L-D1 3.0-6.0 (HP Class) F-160L-D1
Duct Adapter		PD-75A	Kit for Deodorant Filter & Filter Box	B-160H2
Fresh Air Intake Kit		OACI-160K2	Antibacterial Long-life Filter	F-160L-K

NOTES:

1. The cooling and heating capacities above show the maximum capacities when the outdoor and indoor temperature are under the following conditions.

Cooling Operation Conditions		Heating Operation Conditions	
Indoor Air Inlet Temperature:	27.0°C DB 19.0°C WB	Indoor Air Inlet Temperature:	20.0°C DB 7.0°C DB
Outdoor Air Inlet Temperature:	35.0°C DB	Outdoor Air Inlet Temperature:	6.0°C WB
Piping Length:	7.5 metre	Piping Length:	7.5 metre
Piping Lift:	0 metre	Piping Lift:	0 metre

2. The sound pressure level is based on following conditions.  
1.5 metre Beneath the unit.

The data in the table above was measured in an anechoic chamber so that reflected sound should be taken into consideration in the field.



## 4-WAY CASSETTE TYPE [RCI-FSKDNQ]



### FEATURES AND BENEFITS

#### Adaptability



1) Wide Detection area of motion sensor (PS-MSK2)

(Optional part) to achieve better energy-saving



2) Control air flow with individual four air direction

More comfortable air conditioning can be achieved along each zone requirement

#### Design Flexibility



Suitable for high ceiling space

Thanks to cooling air blow up to 5.5m down

### GENERAL DATA & ACCESSORIES

Model			RCI-1.0FSKDNQ	RCI-1.5FSKDNQ	RCI-2.0FSKDNQ	RCI-2.5FSKDNQ	RCI-3.0FSKDNQ	RCI-4.0FSKDNQ	RCI-5.0FSKDNQ	RCI-6.0FSKDNQ
Indoor Unit Power Supply			AC 1Φ, [220-240V/50Hz] [220V/60Hz]							
Nominal Capacity	Cooling	kW	2.8	4.0	5.6	7.1	8.0	11.2	14.0	16.0
	Heating	kW	3.2	4.8	6.3	8.5	9.0	12.5	16.0	18.0
Sound Pressure Level	(Hi2/Hi/Me/Lo)	dB(A)	33/30/28/27	35/31/30/27	37/32/30/27	42/36/32/28	42/36/32/28	48/43/39/33	48/45/40/35	48/46/41/37
Outer Dimension	(H×W×D)	mm	238×840×840	238×840×840	238×840×840	238×840×840	288×840×840	288×840×840	288×840×840	288×840×840
Net Weight		kg	20	21	21	22	26	26	26	26
Refrigerant			R410A	R410A	R410A	R410A	R410A	R410A	R410A	R410A
Indoor Fan Air Flow Rate	(Hi2/Hi/Me/Lo)	m <sup>3</sup> /min	15/13/11/9	21/17/14/11	22/17/14/11	27/23/18/14	27/23/18/14	37/31/24/20	37/33/26/21	37/35/28/22
Connections			Flare-Nut Connection (with flare Nuts)							
Refrigerant	Liquid Line	mm	Φ6.35	Φ6.35	Φ6.35	Φ9.52	Φ9.52	Φ9.52	Φ9.52	Φ9.52
Piping Diameter	Gas Line	mm	Φ12.7	Φ12.7	Φ12.7	Φ15.88	Φ15.88	Φ15.88	Φ15.88	Φ15.88
Condensate Drain			VP25	VP25	VP25	VP25	VP25	VP25	VP25	VP25
Approximate Packing Volume		m <sup>3</sup>	0.21	0.21	0.21	0.21	0.25	0.25	0.25	0.25

Adaptable Panel Model	Included (without Motion Sensor)
Colour	Neutral White
Outer Dimension (H×W×D)	mm 40×950×950
Net Weight	kg 6.5
Approximate Packing Volume	m <sup>3</sup> 0.10

Decoration Panel	- (Standard)
Receiver Kit	PC-ALH3
Motion Sensor	PS-MSK2
Condensate Drain Pump	- (Standard)

#### NOTE:

1. The cooling and heating capacities above show the maximum capacities when the outdoor and indoor temperature are under the following conditions.

##### Cooling Operation Conditions

Indoor Air Inlet Temperature: 27.0°C DB (80.0°F DB)  
19.0°C WB (66.2°F WB)  
Outdoor Air Inlet Temperature: 35.0°C DB (95.0°F DB)

Piping Length: 7.5 metre  
Piping Lift: 0 metre

##### Heating Operation Conditions

Indoor Air Inlet Temperature: 20.0°C DB (68.0°F DB)  
7.0°C DB (45.0°F DB)  
Outdoor Air Inlet Temperature: 6.0°C WB (43.0°F WB)

Piping Length: 7.5 metre  
Piping Lift: 0 metre

2. The sound pressure level is based on following conditions.

1.5 metre Beneath the unit.

The data in the table above was measured in an anechoic chamber so that reflected sound should be taken into consideration in the field.

3. Decoration panel is included.



## 4-WAY CASSETTE COMPACT TYPE



### FEATURES AND BENEFITS

#### Adaptability



1) Wide Detection area of motion sensor (SOR-NEC)

(Optional part) to achieve better energy-saving



2) Top-class silent operation

As quiet as gentle breeze

#### Design Flexibility



Compact

Adaptation to 600×600mm ceilings

### GENERAL DATA & ACCESSORIES

Model			RCIM-0.8FSN4	RCIM-1.0FSN4	RCIM-1.5FSN4	RCIM-2.0FSN4	RCIM-2.5FSN4
Indoor Unit Power Supply			AC 1Φ, [230V/50Hz] [220-240V/50Hz] [220V/60Hz]				
Nominal Capacity	Cooling	kW	2.2	2.8	4.0	5.6	7.1
	Heating	kW	2.5	3.2	4.8	6.3	8.5
Sound Pressure Level	(Hi2/Hi/Me/Lo)	dB(A)	36/33/29/24.5	38/34/30/24.5	41/37/33/27.5	45/39/35/31	47/43/39/35
Outer Dimension	(H×W×D)	mm	285×570×570	285×570×570	285×570×570	285×570×570	285×570×570
Net Weight		kg	16	16	16	17	17
Refrigerant			R410A	R410A	R410A	R410A	R410A
Indoor Fan Air Flow Rate	(Hi2/Hi/Me/Lo)	m <sup>3</sup> /min	11/9.5/8/6	12/10/8.5/6	13/11/9.5/7	15/12/10/8	16/14/12/10
Connections			Flare-Nut Connection (with Flare Nuts)				
Refrigerant Piping Diameter	Liquid Line	mm	Φ6.35	Φ6.35	Φ6.35	Φ6.35	Φ9.52
	Gas Line	mm	Φ12.7	Φ12.7	Φ12.7	Φ12.7	Φ15.88
Condensate Drain			VP25	VP25	VP25	VP25	VP25
Approximate Packing Volume		m <sup>3</sup>	0.13	0.13	0.13	0.13	0.13

Adaptable Panel Model		P-AP56NAM (without Motion Sensor)
Colour		Neutral White
Outer Dimension (H×W×D)	mm	30×620×620
Net Weight	kg	3.0
Approximate Packing Volume	m <sup>3</sup>	0.04

Decoration panel	P-AP56NAM
Motion Sensor	SOR-NEC
Receiver kit	PC-ALHC1
Duct Adapter	PD-75C

NOTES:

1. The cooling and heating capacities above show the maximum capacities when the outdoor and indoor temperature are under the following conditions.

Cooling Operation Conditions

Indoor Air Inlet Temperature: 27.0°C DB  
19.0°C WB

Outdoor Air Inlet Temperature: 35.0°C DB

Piping Length: 7.5 metre

Piping Lift: 0 metre

Heating Operation Conditions

Indoor Air Inlet Temperature: 20.0°C DB

Outdoor Air Inlet Temperature: 7.0°C DB

6.0°C WB

Piping Length: 7.5 metre

Piping Lift: 0 metre

2. The sound pressure level is based on following conditions.

1.5 metre Beneath the unit.

The data in the table above was measured in an anechoic chamber so that reflected sound should be taken into consideration in the field.

3. RCIM-0.6FSN4 cannot be connected to HNRQ series.

Please refer to the technical catalogue for the details.



## 2-WAY CASSETTE TYPE



### FEATURES AND BENEFITS

#### ★ Adaptability

- 1) Wide Detection area of motion sensor (SOR-NED)  
(Optional part) to achieve better energy-saving
- 2) Control air flow with individual four air direction

#### ♡ Comfort

- Setback temperature control available, leading to better operation.
- GentleCool control to ensure you are not bothered by cold draft

#### ✏ Design Flexibility

- Suitable for high ceiling space.  
Thanks to 4.6m cooling air blow down.

### GENERAL DATA & ACCESSORIES

Model		RCD-0.8FSN3	RCD-1.0FSN3	RCD-1.5FSN3	RCD-2.0FSN3	RCD-2.5FSN3	RCD-3.0FSN3	RCD-4.0FSN3	RCD-5.0FSN3	RCD-6.0FSN3	
Indoor Unit Power Supply		AC 1Φ, [220-240V/50Hz] [220V/60Hz]									
Nominal Capacity	Cooling	kW	2.2	2.8	4.0	5.6	7.1	8.0	11.2	14.0	16.0
	Heating	kW	2.5	3.2	4.8	6.3	8.5	9.0	12.5	16.0	18.0
Sound Pressure Level	(Hi2/Hi/Me/Lo)	dB(A)	30/29/28/27	31/29/28/27	37/34/31/30	39/36/33/30	42/39/36/33	45/42/38/33	43/40/37/34	47/44/41/35	48/45/42/39
Outer Dimension (H×W×D)		mm	298×860×630	298×860×630	298×860×630	298×860×630	298×860×630	298×860×630	298×1,420×630	298×1,420×630	298×1,420×630
Net Weight		kg	23	23	25	25	25	25	39	39	39
Refrigerant			R410A	R410A	R410A	R410A	R410A	R410A	R410A	R410A	R410A
Indoor Fan Air Flow Rate	(Hi2/Hi/Me/Lo)	m <sup>3</sup> /min	10/9/7.5/6.5	11/9.5/8.5/7	15/13/11.5/10	16.5/14.5/12.5/10.5	18.5/16.5/14.5/12.5	21/18.5/16/12.5	30/26.5/23/20	35/31/27/21	37/32.5/28.5/24
Connections			Flare-Nut Connection (with Flare Nuts)								
Refrigerant Piping Diameter	Liquid Line	mm	Φ6.35	Φ6.35	Φ6.35	Φ6.35	Φ9.52	Φ9.52	Φ9.52	Φ9.52	Φ9.52
	Gas Line	mm	Φ12.7	Φ12.7	Φ12.7	Φ12.7	Φ15.88	Φ15.88	Φ15.88	Φ15.88	Φ15.88
Condensate Drain			VP25	VP25	VP25	VP25	VP25	VP25	VP25	VP25	VP25
Approximate Packing Volume		m <sup>3</sup>	0.24	0.24	0.24	0.24	0.24	0.24	0.36	0.36	0.36

Adaptable Panel Model		P-AP90DNA (for RCD-[0.8-3.0]FSN3)	P-AP160DNA (for RCD-[4.0-6.0]FSN3)
Colour		Neutral White	Neutral White
Outer Dimension (H×W×D)		30×1,100×710	30×1,660×710
Net Weight		7.5	10.5
Approximate Packing Volume		0.13	0.20

Decoration panel	0.8-3.0 (HP Class)	P-AP90DNA	Antibacterial Long-life Filter	0.8-3.0 (HP Class)	F-90MD-K1
	4.0-6.0 (HP Class)	P-AP160DNA		4.0-6.0 (HP Class)	F-160MD-K1
Receiver kit		PC-ALHD1		0.8-3.0 (HP Class)	B-90HD
Motion Sensor		SOR-NED	Filter Box	4.0-6.0 (HP Class)	B-160HD
Duct Adapter		PD-150D			

#### NOTES:

1. The cooling and heating capacities above show the maximum capacities when the outdoor and indoor temperature are under the following conditions.

Cooling Operation Conditions		Heating Operation Conditions	
Indoor Air Inlet Temperature:	27.0°C DB	Indoor Air Inlet Temperature:	20.0°C DB
	19.0°C WB	Outdoor Air Inlet Temperature:	7.0°C DB
Outdoor Air Inlet Temperature:	35.0°C DB		6.0°C WB
Piping Length:7.5 metre		Piping Length:7.5 metre	
Piping Lift:0 metre		Piping Lift:0 metre	

2. The sound pressure level is based on following conditions.

1.5 metre Beneath the unit.  
The data in the table above was measured in an anechoic chamber so that reflected sound should be taken into consideration in the field.





## 1-WAY CASSETTE TYPE



### FEATURES AND BENEFITS

#### Adaptability



1) Wide Detection area of motion sensor (SOR-NES)

(Optional part) to achieve better energy-saving



2) Quiet operation

New design in fan inlet and fan resulted in the low sound pressure

#### Design Flexibility



3 installation types selectable

- Corner type (standard)
- Clipped ceiling (one-way) type
- Clipped ceiling (two-way) type

### GENERAL DATA & ACCESSORIES

Model			RCS-0.8FSN	RCS-1.0FSN	RCS-1.5FSN	RCS-2.0FSN	RCS-2.5FSN	RCS-3.0FSN
<b>Indoor Unit Power Supply</b>			AC 1Φ, [220-240V/50Hz] [230V/50Hz] [220V/60Hz]					
<b>Nominal Capacity</b>	Cooling	kW	2.2	2.8	4.0	5.6	7.1	8.0
	Heating	kW	2.5	3.2	4.8	6.3	8.5	9.0
<b>Sound Pressure Level</b>	(Hi2/Hi/Me/Lo)	dB(A)	34/32/29/27	36/34/31/28	40/37/33/31	42/38/35/31	43/39/36/32	43/40/37/33
<b>Outer Dimension</b>	(H×W×D)	mm	235×900×710	235×900×710	235×900×710	235×900×710	235×1,210×710	235×1,210×710
<b>Net Weight</b>		kg	25	25	26	26	33	33
<b>Refrigerant</b>			R410A	R410A	R410A	R410A	R410A	R410A
<b>Indoor Fan Air Flow Rate</b>	(Hi2/Hi/Me/Lo)	m <sup>3</sup> /min	8.5/7.5/6.5/6	9.5/8.5/7.5/6.5	13/11.5/10/8.5	14.5/13/11/9.5	18.5/16.5/14.5/12.5	20/17.5/15.5/13
<b>Connections</b>			Flare-Nut Connection (with Flare Nuts)					
<b>Refrigerant Piping Diameter</b>	Liquid Line	mm	Φ6.35	Φ6.35	Φ6.35	Φ6.35	Φ9.52	Φ9.52
	Gas Line	mm	Φ12.7	Φ12.7	Φ12.7	Φ12.7	Φ15.88	Φ15.88
<b>Condensate Drain</b>			VP25					
<b>Approximate Packing Volume</b>		m <sup>3</sup>	0.25	0.25	0.25	0.25	0.32	0.32

Adaptable Panel Model		P-AP36CNA (for RCS-[0.8-1.0]FSN)	P-AP56CNA (for RCS-[1.5-2.0]FSN)	P-AP80CNA (for RCS-[2.5-3.0]FSN)
<b>Colour</b>		Neutral White		Neutral White
<b>Outer Dimension</b>	(H×W×D)	35×1,100×800	35×1,100×800	35×1,410×800
<b>Net Weight</b>		4.5	4.5	6.0
<b>Approximate Packing Volume</b>		0.098	0.098	0.125

<b>Decoration panel</b>	0.8-1.0 (HP Class)	P-AP36CNQ	<b>Drille for Front Discharge</b>	0.8-2.0 (HP Class)	DG-56SW1
	1.5-2.0 (HP Class)	P-AP56CNA		2.5-3.0 (HP Class)	DG-80SW1
	2.5-3.0 (HP Class)	P-AP80CNA		0.8-2.0 (HP Class)	PIS-56LS
<b>Receiver kit</b>		PC-ALHS1	<b>Air Outlet Shutter Plate</b>	2.5-3.0 (HP Class)	PIS-80LS
<b>Motion Sensor</b>		SOR-NES			
<b>Duct Adapter</b>		PD-100			

NOTES:

1. The cooling and heating capacities above show the maximum capacities when the outdoor and indoor temperature are under the following conditions.

Cooling Operation Conditions		Heating Operation Conditions	
Indoor Air Inlet Temperature:	27.0°C DB	Indoor Air Inlet Temperature:	20.0°C DB
	19.0°C WB	Outdoor Air Inlet Temperature:	7.0°C DB
Outdoor Air Inlet Temperature:	35.0°C DB		6.0°C WB
Piping Length:	7.5 metre	Piping Length:	7.5 metre
Piping Lift:	0 metre	Piping Lift:	0 metre

2. The sound pressure level is based on following conditions.  
1.5 metre Beneath the unit.

The data in the table above was measured in an anechoic chamber so that reflected sound should be taken into consideration in the field.



# Control system

Whether you are at work or play, SET FREE mini allows you to have control over your living environment. By providing control systems that are easy to understand and use, we enable you to easily and accurately achieve optimal air conditioning management in a whole range of living spaces.

## INDEX

34	LINE UP OVERVIEW -INDIVIDUAL CONTROLLERS
35	INDIVIDUAL CONTROLLERS
39	OTHERS
40	LINE UP OVERVIEW -CENTRALISED CONTROLLERS
41	CENTRALISED CONTROLLERS
49	H-LINK

# LINE UP OVERVIEW

## COMPARING INDIVIDUAL CONTROLLERS

WIRED REMOTE CONTROLLER



HCWA10NEGQ

SIMPLIFIED WIRED REMOTE CONTROLLER



PC-ARH1

ADVANCED WIRELESS REMOTE CONTROLLER



PC-AWR

ADVANCED WIRED REMOTE CONTROLLER



PC-ARF1

		HCWA10NEGQ	PC-ARH1	PC-AWR	PC-ARF1	
Connection Capacity	RC Groups	1	1	-	1	
	Indoor units (*1)	16	16	-	16	
Setting	Temperature Setting Rate (*2)	0.5°C/1.0°C/1.0°F	0.5°C/1.0°C/1.0°F	0.5°C/1.0°C/1.0°F	0.5°C/1.0°C/1.0°F	
	Indoor Fan Speed (*2) (*3)	3/4/6 taps	3/4/6 taps	3/4/6 taps	3/4/6 taps	
	Louvre Direction (*2)	●	●	●	●	
	Individual Louvre Setting (*2)	●	-	-	●	
	Remote Control Primary-Secondary Setting	-	●	-	●	
	Function Selection	Automatic Restart with Eco-operation	-	-	-	●
		Automatic Reset Temperature (Cooling)	●	●	-	●
		Temperature Indication (*4)	●	-	-	●
	Service & Installation	Filter Sign	●	-	-	●
		Filter Sign Reset	●	-	●	●
Louvre Open/Close		-	-	-	●	
Room Name Setting		-	-	-	●	
Alarm Sign		●	●	-	●	
Identifying indoor units side-by-side		-	-	●	-	
Screen		Screen Adjustment	-	-	-	●
		Language	-	-	-	●
Check Menu		Temperature Unit-°C/°F	●	● (*5)	●	●
		Adjusting Brightness of Run Indicator	-	-	-	●
	Sensor Condition Check	●	-	-	●	
	Model Display (*2)	-	-	-	●	
	Indoor/Outdoor PCB Check	-	-	-	●	
Management	Alarm History Display	●	-	-	●	
	Operation Lock/Set	● (*6)	-	-	●	
	Lower Limit for Cooling Operation	●	●	-	●	
	Upper Limit for Heating Operation	●	●	-	●	
	Built-in Timer (On/Off)	●	-	●	●	
	Adjusting Date/Time Setting	●	-	-	●	
	Automatic OFF timer setting	-	●	-	●	
	Schedule	Weekly Schedule	●	-	-	●
		Settable Timer Operation Times (Per Day)	1	-	-	5
		Holiday Setting	-	-	-	●
Schedule On/Off		-	-	-	●	
Power Saving	Power Saving with Motion Sensor	-	-	-	●	
	Outdoor Unit capacity control	Peak cut control	-	-	-	●
		moderate control	-	-	-	●
	Indoor Unit Rotation Control	Indoor Unit Address	-	-	-	●
		Indoor Air Temperature difference	-	-	-	●
	Automatic Fan Operation	-	-	-	●	
MENU	ODU silent mode	-	-	-	●	
	Quick Function	-	-	-	●	
	Comfort setting Control Cool Air	-	-	-	●	
	Saving/ODU Noise Reduction Schedule	-	-	-	●	
	Daylight Saving Time	-	-	-	●	
Power Consumption visualisation	-	-	-	●		

(\*1) All 16 indoor units need to be connected with transition wire.

(\*2) Availability depends on the indoor unit type connected to the each individual controllers. Please consult your distributors for more details.

(\*3) 6 taps is available for RPIZ-HNDTSQ only.

(\*4) Indicated temperature can be selected from two options, the thermistor in the indoor unit or in the individual controller.

(\*5) Please contact your distributor in case temperature unit needs to be changed from °C to °F.

(\*6) Only "bulk operation lock" available

# WIRED REMOTE CONTROLLER **HCWA10NEGQ**

Temperature display  
Room temperature  
RT 26.0°C | 79.0°F

Set temperature  
SET 26.0°C | 79.0°F

ON/OFF Button  
Mode Button

Liquid Crystal Display (LCD) Screen

Up Button & Down Button

Operation Mode

- Cooling Mode ❄️
- Heating Mode ☀️
- Dry Mode 💧
- Fan Mode 🌀
- Auto Mode 🔄

Fan Speed Setting

Timer/Clock Setting

Fan Speed

(flickering)

MAX

MIN

Timer Setting

- ON Timer On
- OFF Timer Off
- ONCE Timer Valid for One Time
- DAILY Timer Valid for One Day
- WEEKLY Timer Set for a Week

## SPECIFICATIONS

### Outer Dimensions (H×W×D)

(mm) 88.0×88.0×15.5

## FUNCTIONS

	Run/Stop
	Operation Mode
	Auto Mode
<b>Setting</b>	Temperature Setting Rate 0.5°C/1.0°C/1.0°F
	Temperature Unit °C/°F
	Fan Speed 3/4/6 taps
	Louvre Direction
<b>Service</b>	Individual Louvre Setting
	Filter Sign
	Filter Sign Reset
	Alarm Sign
<b>Schedule &amp; Management</b>	Alarm Sign History
	Daily Timer
	Weekly Timer
	Main-sub Control
	Operation Lock

Notes:

1. Fan Speed Taps setting unit availability varies with the indoor unit. Please check each technical catalogue in advance.
2. Initial Setting of temperature display is "Set temperature" display only. Please contact your dealer to display room temperature.
3. HCWA10NEGQ can be connected to HNRQ series only, not to Top Flow VRF. Please refer to the technical catalogue for the details.

# SIMPLIFIED WIRED REMOTE CONTROLLER **PC-ARH1**

Run Indicator (Red)

ON/OFF Switch

Operation Mode Switch

- FAN
- COOL
- HEAT
- DRY
- AUTO

By repeatedly pressing the button, the setting will change sequentially.

TEMP (Temperature Setting) Switch

Swing Louvre (Swing Louvre Operation) Switch

Fan Speed Switch

By repeatedly pressing the button, the fan speed setting will change sequentially.

## SPECIFICATIONS

### Outer Dimensions (H×W×D)

(mm) 120.0×70.0×17.0

## FUNCTIONS

	Run/Stop
	Operation Mode
	Auto Mode Setting
<b>Setting</b>	Temperature Setting
	Temperature setting rate 0.5°C/1.0°C/1.0°F
	Back-light screen
	Fan Speed 3/4/6 taps
	Louvre Direction

\* Please contact your dealer in case "temperature setting rate" needs to be changed from °C to °F.

# WIRELESS REMOTE CONTROLLER PC-AWR



## SPECIFICATIONS

**Outer Dimensions (H×W×D)**  
(mm) 140.0×55.0×16.8

## FUNCTIONS

<b>Setting</b>	Run/Stop
	Operation Mode
	Auto Mode Setting
	Temperature Setting
	Temperature Setting Rate_0.5°C/1.0°C/1.0°F
	Fan Speed_3/4/6 Taps
<b>Service</b>	Louvre Direction
	Filter Sign Reset
	Identifying indoor units side-by-side
<b>Schedule</b>	Temperature Unit_°C/°F
	Built-in Timer (On/Off)

## EXAMPLE OF SYSTEM CONFIGURATION

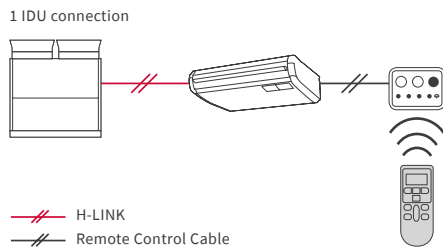

## RECEIVER KIT FOR WIRELESS REMOTE CONTROLLER

<b>Model</b>	<b>PC-ALHZ1</b>	<b>PC-ALHP1</b>	<b>PC-ALH3</b>	<b>PC-ALHC1</b>	<b>PC-ALHD1</b>	<b>PC-ALHS1</b>		
<b>For indoor unit model</b>	Ducted	Wall Mounted	Floor/Ceiling Convertible	Ceiling Suspended	4-Way Cassette	4-Way Cassette Compact	2-Way Cassette	1-Way Cassette

# ADVANCED WIRED REMOTE CONTROLLER PC-ARF1

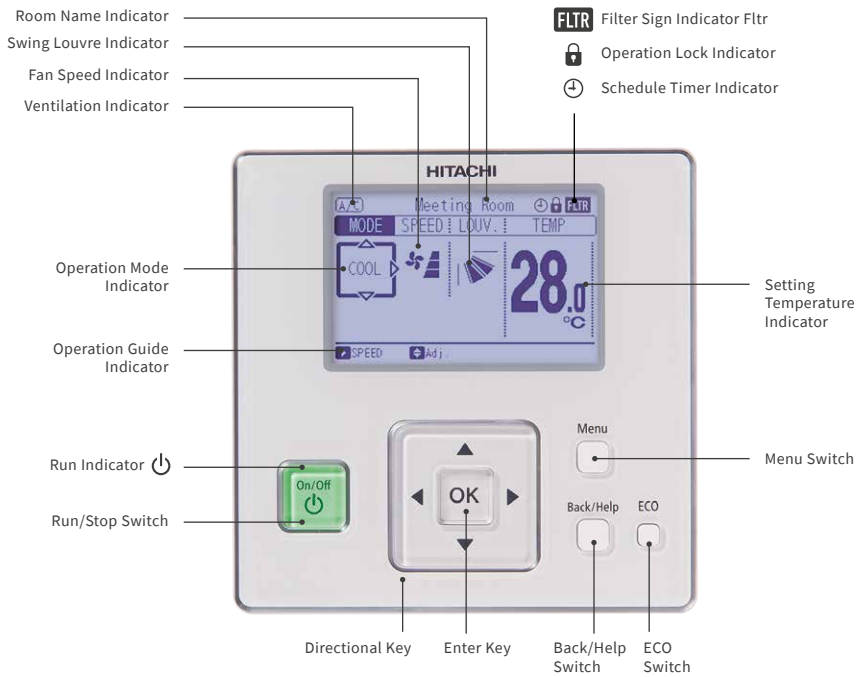

## SPECIFICATIONS

### Outer Dimensions (H×W×D)

(mm) 120.0×120.0×17.9

## EXAMPLE OF SYSTEM CONFIGURATION

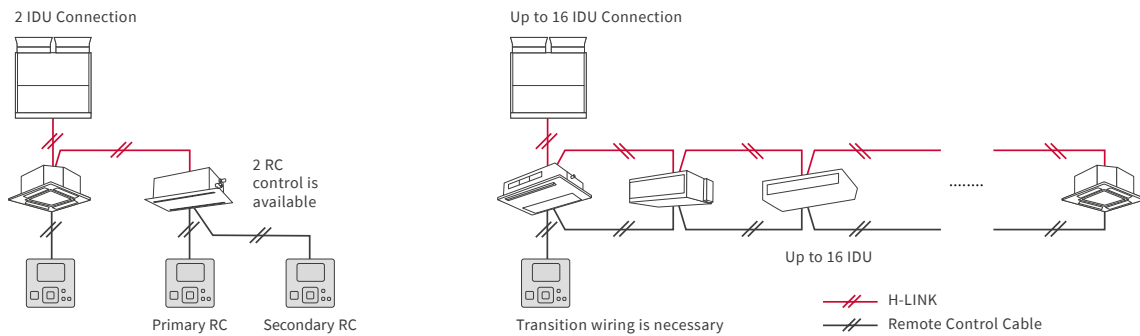

## FUNCTIONS

<b>Setting</b>	Run/Stop	<b>Service</b>	Filter Sign	<b>Power-Saving</b>	With Motion Sensor Kit
	Operation Mode		Filter Sign Reset		ODU Capacity Control
	Auto Mode Setting		Louvre Open/Close		• Peak-cut Control
	Temperature Setting		Room Name Setting		• Moderate Control
	Temperature Setting Rate_0.5°C/1.0°C/1.0°F		Alarm Sign		Indoor Unit Rotation Control
	Fan Speed_3/4/6 taps		Alarm History Display		Automatic Fan Operation
	Louvre Direction		Screen Adjustment		Auto Recovery of Temperature
	Individual Louvre Setting		Temperature Unit_°C/°F		Upper Limit for Heating Operation
	Remote Control Primary-Secondary Setting		Adjusting Brightness of Run Indicator		Lower Limit for Cooling Operation
	Function Selection		Operation Lock/Set		Weekly Schedule
	Main/Sub Control	Settable Timer Operation Times (per day): 5			
	Built-in-Timer (On/Off)	Holiday Setting			
	Adjusting Date/Time Setting	Schedule On/Off			
	Thermometer Indication	ODU Noise Reduction Schedule			

## POWER-SAVING FUNCTION

### Indoor Unit Rotation Control

Switch multiple indoor units operation to "FAN" mode, one by one, in order.

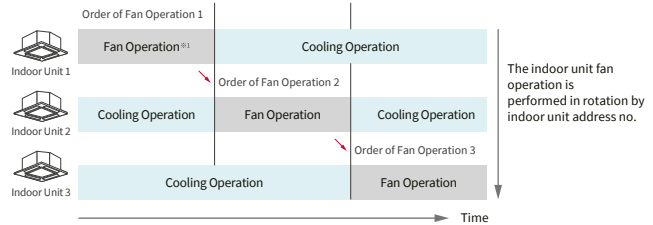

### Automatic fan operation

Alternate between "heating/cooling" and "FAN" at a certain interval.

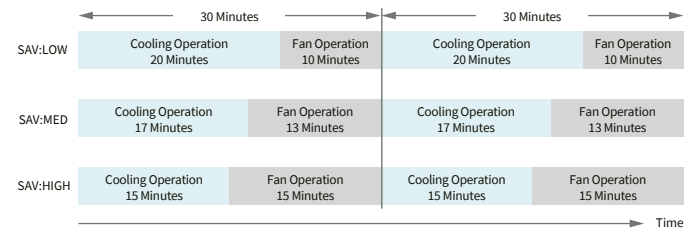

### Auto-Recovery of Temperature

Reducing excessive energy consumption thanks to automatic temperature reset.

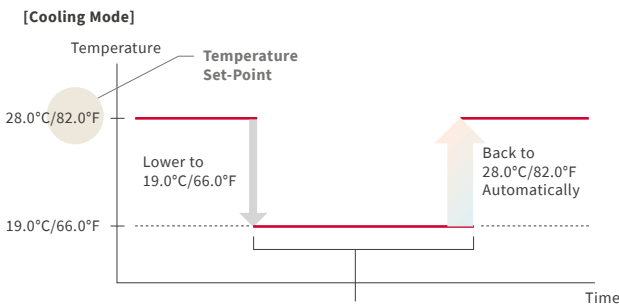

After a certain time passes, the changed temperature returns to the set point. The time can be selected from four options (15-30-60-90 mins).

### Temperature Range Setting

Prevent wasteful power consumption due to excessive use of cooling/heating mode.

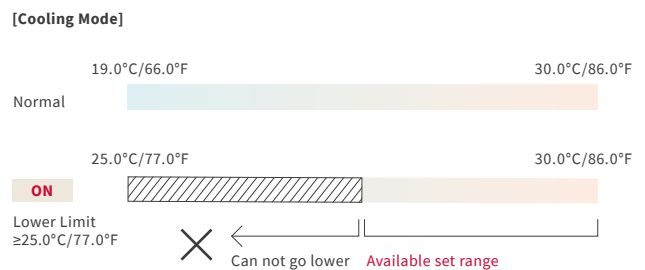

## ADAPTABILITY

### Improved main-sub RC control

By one main RC, you can control the multiple IDUs which are controlled by sub RC.

- \* Operation Mode
- \* Setting Temperature

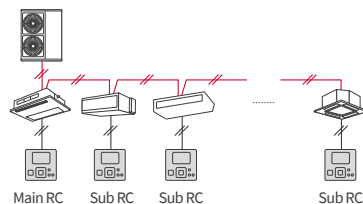

### Temperature Setting Rate

Setting available in 0.5°C/1.0°C or 1.0°F.



### Power consumption visualisation

Check power consumption in the unit of day, week, and year.

※ ODU compressor only

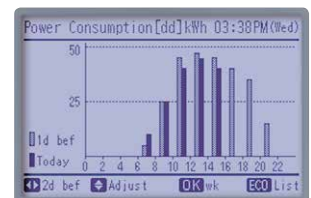

# BMS ADAPTER for BACnet® HC-A64BNP1

Control up to 64 Indoor Units



## SPECIFICATIONS

**Outer Dimensions (H×W×D)**  
(mm) 68.0×240.0×154.0

## FUNCTIONS

<b>Corresponding BACnet® Standard</b>	ANSI/ASHRAE Standard 135-2004 BACnet®
<b>Control Item at Upper System</b>	<ul style="list-style-type: none"> <li>• Run Stop (Setting)</li> <li>• Operation Mode (Setting)</li> <li>• Fan Speed Level (Setting)</li> <li>• Indoor Temperature (Setting)</li> <li>• Prohibiting RC Operation (Setting)</li> <li>• Filter Sign Reset</li> </ul>
<b>Monitoring Item at Upper System</b>	<ul style="list-style-type: none"> <li>• Run Stop (State)</li> <li>• Operation Mode (State)</li> <li>• Fan Speed Level (State)</li> <li>• Indoor Temperature (State)</li> <li>• Prohibiting RC Operation (State)</li> <li>• Filter Sign</li> <li>• Indoor Air Intake Temperature</li> <li>• Alarm Signal</li> <li>• Alarm Code</li> <li>• Communication State</li> </ul>

## EXAMPLE OF SYSTEM CONFIGURATION

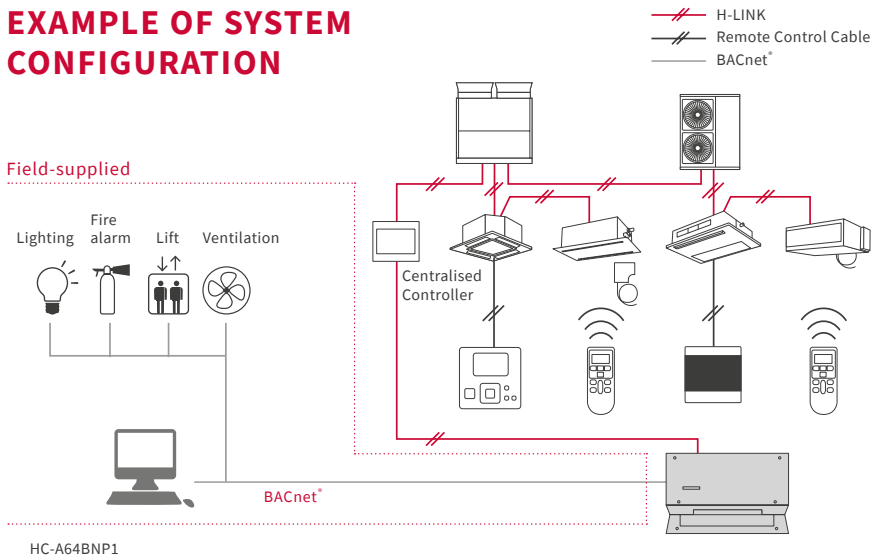



# LINE UP OVERVIEW

## COMPARING CENTRALISED CONTROLLERS

CENTRAL STATION mini



CENTRAL STATION EZ



CENTRAL STATION EX



		PSC-A32MN	PSC-A64GT	PSC-A128EX	
Capacity comparison	Total Connection capacity	RC group	32	64	2,560 (*1)
		Group	4	64	2,048 (*1)
		Block	2/4/8/16	4	512 (*2)
		Area	-	-	512 (*2)
		Indoor unit	160	160	2,560 (*1)
		Outdoor unit	64	64	1,024 (*1)
	Building scale	Small	Medium	Large	
	Operation	Touch screen	Touch screen	Touch screen	
Display	Operation panel size options	4	2	7	
	Layout	-	-	●	
	List options	-	-	3	
	All together	●	●	●	
Operation unit	By layout	-	-	●	
	By area	-	-	●	
	By block	●	●	●	
	By group	-	-	●	
	By RC group	●	●	-	
Control Function	By indoor unit	-	-	●	
	Main 5 functions (*5)	●	●	●	
	Individual controller lock	●	△ (*3)	●	
	Filter sign reset	●	●	●	
	Outdoor unit capacity control	△ (*4)	-	●	
Monitor Function	Outdoor unit noise control	-	-	●	
	Main 5 functions (*5)	●	●	●	
	Individual controller lock	●	●	●	
	Alarm status & code	●	●	●	
	Filter sign	●	●	●	
	Air inlet temperature of indoor unit	●	●	●	
	Air inlet temperature of outdoor unit	●	●	●	
Schedule Function	Weekly	●	●	●	
	Setting times per day	10	10	16	
	Special day setting	-	-	5	
	Annual/Summer/Winter schedule	-	-	●	
Other function	Alarm history (records number)	100	100	10,000	
	External in/output history	-	-	1,000	
	Management report visualisation	●	●	●	
	Data output by external media	-	-	SD card, USB flash device	

(\*1) One external adapter can control [128 remote controller groups/128 groups/32 blocks], and Central Station EX can connect up to 15 adapters.  
 (\*2) No restriction on the number of H-LINK  
 (\*3) Individual Function Control in Each Remote Controller is not applicable  
 (\*4) Applicable by Schedule function or External Signal input  
 (\*5) Main 5 functions mean 1) Run/Stop 2) Operation mode 3) Temperature setting 4) Fan speed 5) Louvre control

# CENTRAL STATION mini FOR SMALL-SCALE BUILDINGS

PSC-A32MN

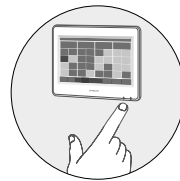

Most compact in our touch panel centralised controller. Its down-to-detail control functionalities, such as Weekly Scheduling, Accumulated Work Hours, etc., help you save energy. Up to 32 remote-controlled groups and up to 160 indoor units can be connected to the single air-conditioning system.

## CAPACITY

RC group	32
Group	32
Block	4 Patterns (2/4/8/16)
Indoor Unit	160
Outdoor Unit	64
Building Scale	Small

## SPECIFICATIONS

Rated Power Supply	1-, AC 100-240V, 50/60Hz
Electrical Power Consumption	20W (Max.)
Communication Unit	Units of Adopting for H-LINK
Communication Line	Non-polar 2-wire
Communication Speed	9,600bps
Wiring Length	1,000m (Total Length)
Display	5.0-inch Wide Colour LCD (Full Dot)
Display Control	Touch Panel

## FUNCTIONS

<b>Monitor Function</b>	<ul style="list-style-type: none"> <li>Run/Stop/Abnormality</li> <li>Setting Temperature</li> <li>RC Operation Prohibited Setting</li> <li>Accumulated Operating Time</li> <li>Operation Mode</li> <li>Setting Fan Speed</li> <li>Setting Louvre</li> <li>Filter Sign</li> <li>Alarm Code</li> </ul>
<b>Control Function</b>	<ul style="list-style-type: none"> <li>Run/Stop</li> <li>Fan Speed</li> <li>Operation Mode</li> <li>Louvre</li> <li>Temperature Setting</li> <li>RC Operation Prohibited</li> <li>Filter Sign Reset</li> </ul>

\* "All Groups Run/Stop" command signal exception function for selected groups is available by "Exception of Run/Stop Operation." function.

## RECOMMENDED FACILITIES



## EXAMPLE OF SYSTEM CONFIGURATION

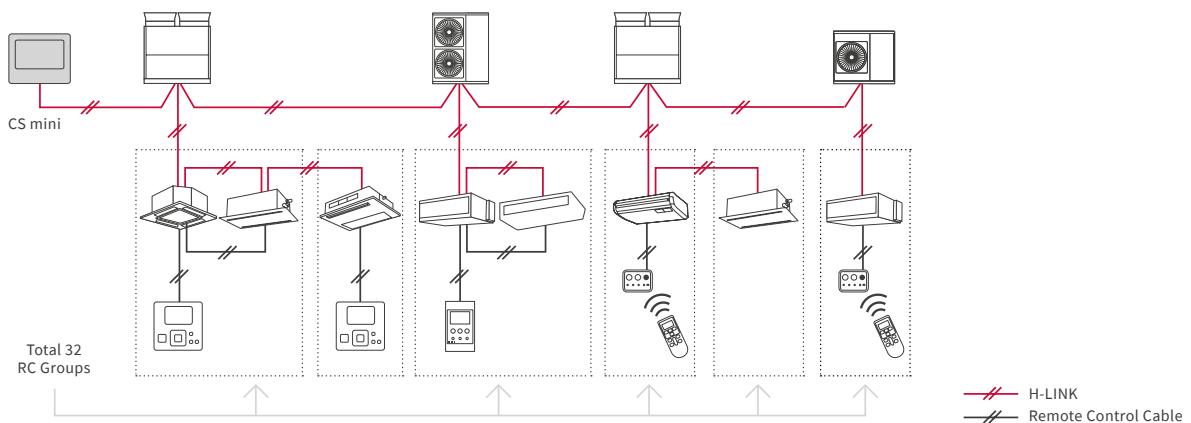

### (5-inch) Touch Panel Operation

Easy to check the operation status using either of two monitoring screens (all groups or four pattern blocks [2/4/8/16])

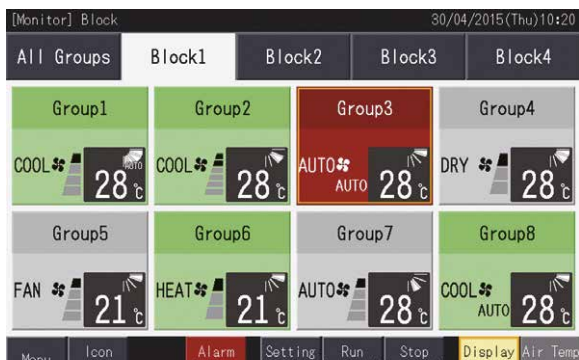

[Monitor (Block)]

### Schedule

Up to 10 actions/day per RC group can be set as available as auto switch-off timer



For example: School



Time	Temp (°C)	Class
9:00 ~ 10:00	27	Class: on
10:00 ~ 11:00	27	Class: on
11:00 ~ 12:00	-	No class: off
12:00 ~ 13:00	25	LUNCH TIME
13:00 ~ 14:00	-	No class: off
14:00 ~ 15:00	27	Class: on
15:00 ~ 16:00	-	No class: off
16:00 ~ 17:00	27	Class: on
17:00 ~	-	No class: off

### RC Group Function Control

-each operational item blocking-prevent incorrect operation

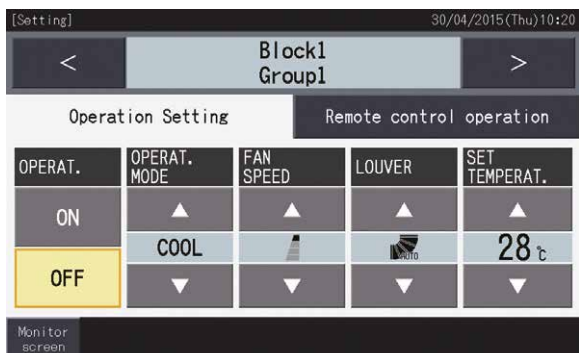

ON/OFF, "operation mode," "fan speed," "swing louvre direction," "setting temperature," and "prohibition of remote control operation for individual items (run/stop, operation mode, fan speed, wind direction, setting temperature)"

### Accumulated Operation-Time Visualisation

Support energy-saving management

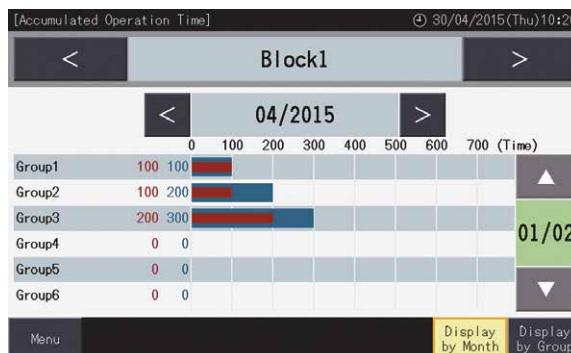

### Energy Saving

Outdoor unit power consumption control by schedule or external signals. Setting temperature range.

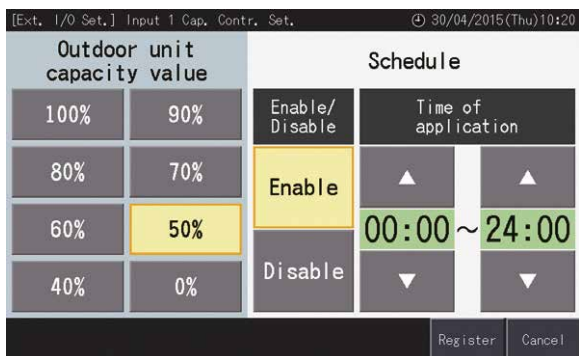

[Capacity Control of ODU]

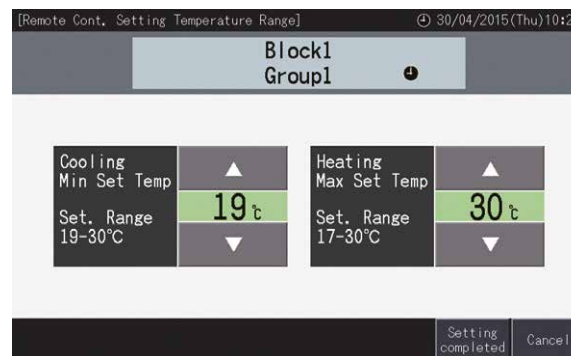

[Temperature Limitation for Each Remote Controller]

# CENTRAL STATION EZ FOR MEDIUM-SCALE BUILDINGS

## PSC-A64GT

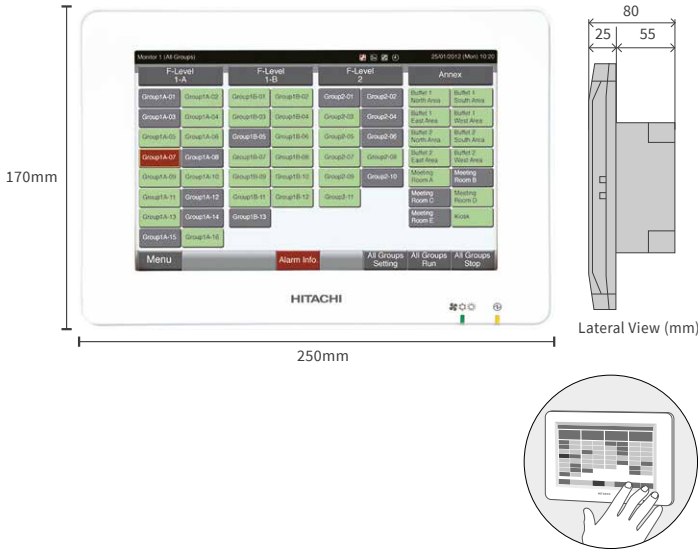

Easy control with 8.5 inch colour touch panel, Its down-to-detail control functionalities, such as Weekly Scheduling, Accumulated Work Hours, etc., help you save energy. Up to 64 remote-controlled groups and up to 160 indoor units can be connected to the single air-conditioning system.

### CAPACITY

RC group	64
Group	64
Block	4 Patterns
Indoor Unit	160
Outdoor Unit	64
Building Scale	Small-Medium

### SPECIFICATIONS

Rated Power Supply	1-, AC 100-240V, 50/60Hz
Electrical Power Consumption	30W (Max.)
Communication Unit	Units of Adopting for H-LINK
Communication Line	Non-polar 2-wire
Communication Speed	9,600bps
Wiring Length	1,000m (Total Length)
Display	8.5-inch Wide Colour LCD (Full Dot)
Display Control	Touch Panel

### FUNCTIONS

<b>Monitor Function</b>	<ul style="list-style-type: none"> <li>Run/Stop/Abnormality</li> <li>Setting Temperature</li> <li>RC Operation Prohibited Setting</li> <li>Accumulated Operating Time</li> <li>Operation Mode</li> <li>Setting Fan Speed</li> <li>Setting Louvre</li> <li>Filter Sign</li> <li>Alarm Code</li> </ul>
<b>Control Function</b>	<ul style="list-style-type: none"> <li>Run/Stop</li> <li>Fan Speed</li> <li>Operation Mode</li> <li>Louvre</li> <li>Temperature Setting</li> <li>RC Operation Prohibited</li> <li>Filter Sign Reset</li> </ul>

\* "All Groups Run/Stop" command signal exception function for selected groups is available by "Exception of Run/Stop Operation." function.

### RECOMMENDED FACILITIES



### EXAMPLE OF SYSTEM CONFIGURATION

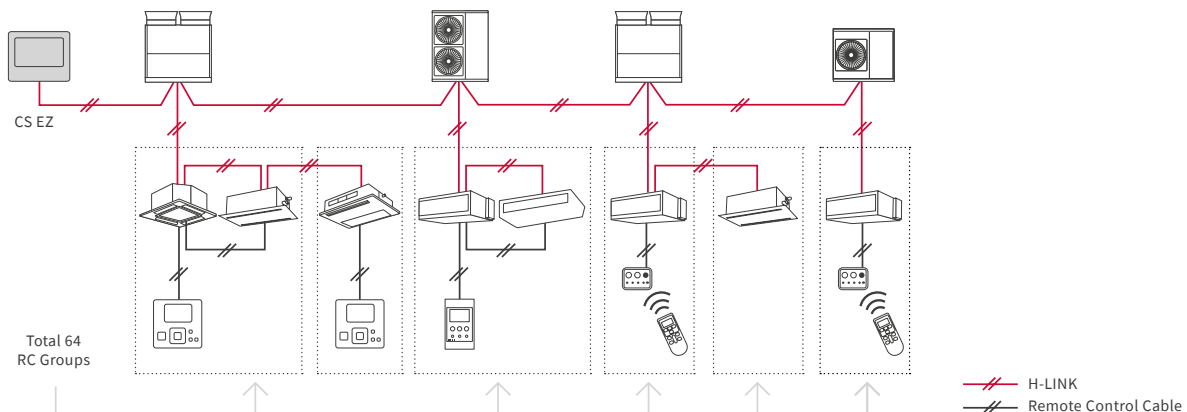

**(8.5-inch) Touch Panel Operation**

A total of 64 remote controller groups (4 blocks)(64 outdoor units/160 indoor units) can be controlled  
 Easy to check the operation status using either of two monitoring screens (all groups or blocks)

The panel for the block is bigger than for the CS MINI; you can check Mode, Fan Speed, Louvre, Temperature, Inlet and Ambient Temperature.

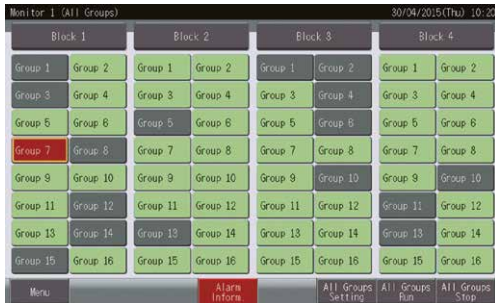

[Monitor 1 (all groups)]



[Monitor 2 (block)]

**ACCUMULATED OPERATION-TIME VISUALISATION**

Supports Energy-Saving Management

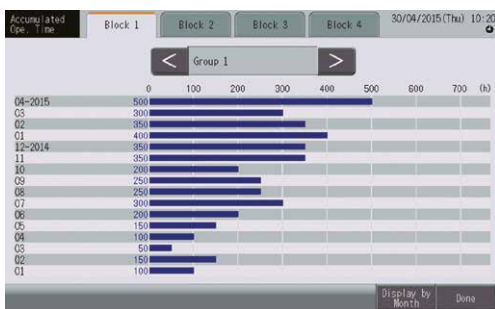

**Alarm Information**

Red colour indication: immediate display of malfunction location and cause.

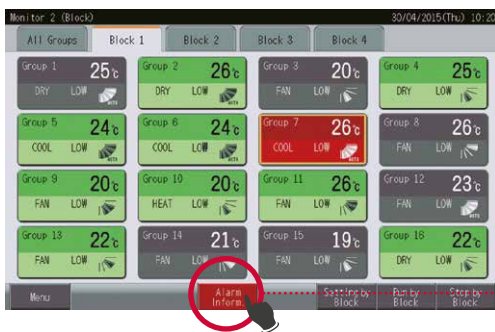

**Schedule**

Up to 10 actions/day per RC groups can be set as available as auto switch-off timer.



[Weekly Schedule]



[Holiday Setting]

# CENTRAL STATION EX FOR LARGE-SCALE BUILDINGS

**PSC-A128EX**



Extension Adapter  
**PSC-AD128EX**



Energy Calculation Software\*  
**PSC-AS01EXC**

\*Required only for calculating electricity

For large scale buildings such as hotels, educational facilities, or hospitals, our Central Station EX features a highly intuitive and functional 12.1-inch wide, wall-mountable, colourful LCD screen. Control up to 2,560 indoor units with our proprietary H-LINK system with 15 Extension Adapters (PSC-AD128EX)

## CAPACITY

<b>H-LINK</b>	16
<b>RC group</b>	2,560 (*1)
<b>Group</b>	2,048 (*1)
<b>Block</b>	512 (*2)
<b>Area</b>	512 (*2)
<b>Indoor unit</b>	2,560 (*1)
<b>Outdoor unit</b>	1,024 (*1)
<b>Building scale</b>	Large

(\*1) One external adapter can control [160 RC groups/128 groups/160 IDUs/64 ODU/Each layout], and Central Station EX can connect up to 15 adapters.

(\*2) No restriction on the number of H-LINK

## SPECIFICATIONS

<b>Rated power supply</b>	100~240VAC±10% (50/60Hz)
<b>Electrical power consumption</b>	50W (Max.)
<b>Communication unit</b>	Units of Adopting for H-LINK
<b>Communication line</b>	Nonpolar Two Wires
<b>Communication speed</b>	9,600bps
<b>Wiring length</b>	1,000m (Total Length)
<b>Display</b>	12.1 inch TFT colour liquid crystal display
<b>Display control</b>	Touch Panel

## RECOMMENDED FACILITIES



## FUNCTIONS

<b>Operation unit</b>	All together Each area Each block Each group Each RC group		
<b>Control function</b>	On/Off Mode Set temperature Fan speed Louvre RC prohibition Filter sign reset Function selection for indoor units (*1) Function selection for outdoor units (*2) Capacity control for outdoor units (*2) Lower noise control for outdoor units (*2)	<b>Schedule function</b>	Each of the following setting is available in 3 different [annual] [summer][winter] category → Weekly schedule → Up to 16 actions can be set per day → Exception day setting: 5 different types → Holiday setting
<b>Monitor function</b>	On/Off Mode Set temperature Air intake temperature RC sensor temperature (*3) Air intake temperature of outdoor unit Fan Speed Louvre RC prohibition Thermo-ON information Filter sign/Auto cleaning fault Alarm status/Alarm codes	<b>History</b>	Alarm history: 10,000 records External In/Output history: 1,000 records Pulse input history: 6 months Each of the following data of up to 2 years can be shown: • Accumulated operation time (min.) • Accumulated thermo-ON time (min.) • Average air intake temp temperature of indoor unit • Average air intake temperature of outdoor unit • Average setting temperature • Average RC sensor temperature
		<b>Management report visualisation</b>	
		<b>External input/output</b>	<b>Energy saving</b> • Run/Stop • RC prohibition • Temperature shift (For Cool/Dry mode: +1.0°C~+9.0°C (+1.0°F~+18.0°F)) (For Heat mode: -1.0°C~-9.0°C (-1.0°F~-18.0°F)) • Mode shift (Mode shifted to Fan when in Cool/Dry mode, and shifted to Stop in Heat mode) • Capacity control on outdoor units • Lower noise control for outdoor units
			<b>Control/Monitor</b> → Controlled items: • Run/Stop • Mode (Cool/Heat) → Monitored items: • Run/Stop • Mode (Cool/Heat) • Alarm state
			<b>Others</b> • Power consumption signal input • Emergency stop

(\*1) Some indoor units may not fully support all functions.

(\*2) It is available for applicable outdoor units only.

(\*3) There is a case that it cannot be shown in the screen, depending on the remote controller setting.

## EASY TO READ, EASY TO USE

The stand-alone Central Station EX uses a touch screen, capacitive LCD panel.

Better display resolution (1,280x800)  
Larger screen (12.1 inches wide)

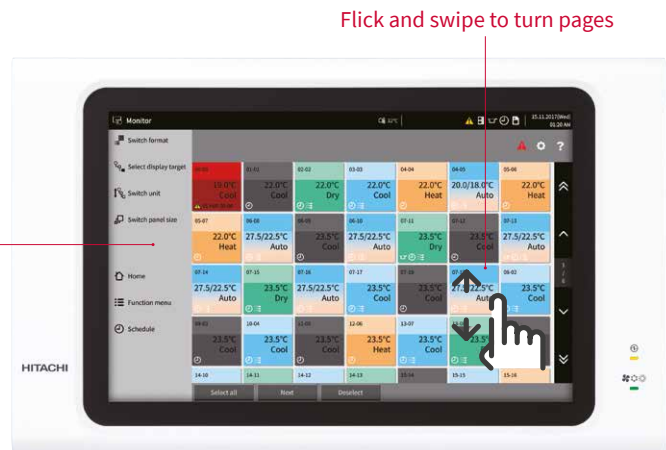

Flick and swipe to turn pages

## BETTER ENERGY SAVING AND QUICKER MANAGEMENT

Management reports can be visualised in various ways, and data can be acquired using SD memory and USB flash devices.

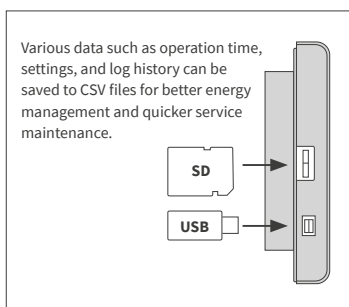

The following data can be displayed up to the previous two years:

- Accumulated operation time (min.)
- Accumulated thermo-ON time (min.)
- Average air intake temperature of indoor unit
- Average air intake temperature of outdoor unit
- Average setting temperature
- Average RC sensor temperature (It may not be available depending on RC settings.)



## IMPROVED SCHEDULE SETTING

Three long-term category settings are now available: Annual, Summer, and Winter.

Touch and hold the memory axis to add the memory to the schedule

Schedules can be colour coded for easy confirmation

Touch the + button to see the detailed schedule

Drag to change the schedule  
Flick and swipe to see a different screen

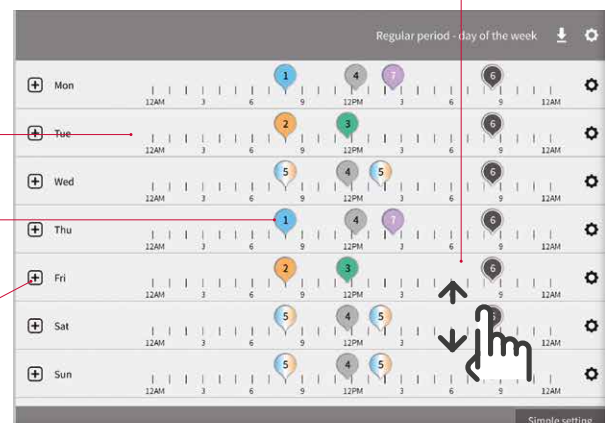

# CENTRAL STATION EX FOR LARGE-SCALE BUILDINGS

## PSC-A128EX

### INTUITIVE INTERFACE FOR BETTER MONITORING

Three monitoring styles are available.

#### 1. Panel style

The panel colour clearly shows the air conditioner operation mode.

One maximum-sized panel can show the following items with colours and icons for easy confirmation:

- Room name
- Run/stop
- Mode
- Temperature
- Fan speed
- Louvre
- Air intake temperature (RC sensor temperature or indoor temperature)
- Current status icon

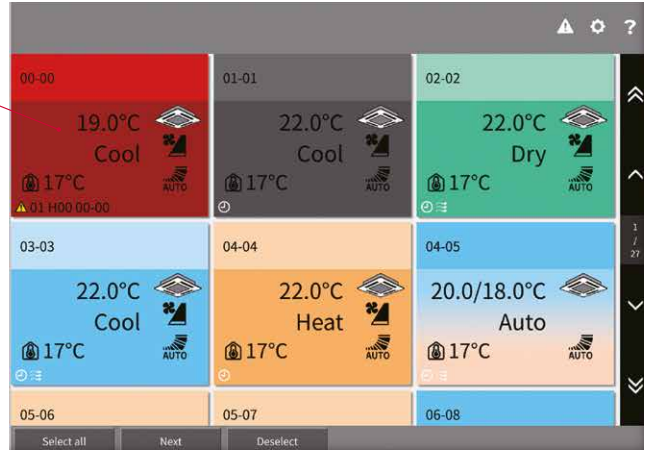
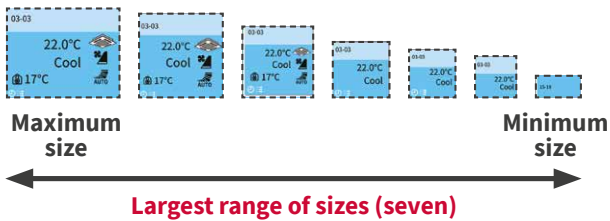

#### 2. Layout style

Upload your own layout images in multiple formats (BMP, JPEG, PNG) and easily arrange indoor units by dragging them on the touch panel.



Floor view

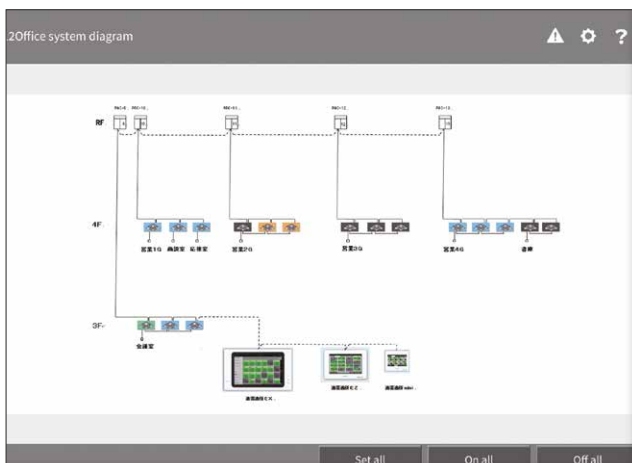

System diagram



Actual room image



### 3. List style

Setting/control information is shown in a list that can be filtered and sorted for easy confirmation and comparison. In the list display, normal temperature and power consumption are provided so users can select formats according to their desired items.

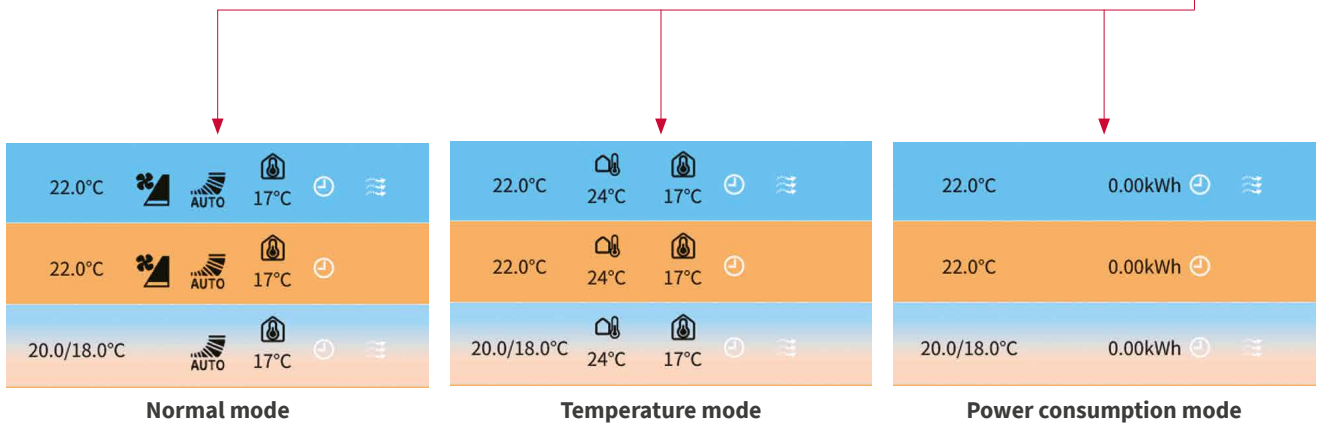

# H-LINK

## WHAT IS H-LINK?

H-LINK is a "Hitachi" original communication system that can be used to control multiple outdoor and indoor units from one control point. Its use assists installers and service engineers by simplifying commissioning and service maintenance. For building owners and occupants, it provides outstanding versatility enabling the connection of various types of central control options, enabling better system management. Our proprietary high-performance communication system enables the connection of control wiring between indoor and outdoor units, and between a centralised control system and indoor/outdoor units across two or more refrigerant systems.

### Basic Wiring

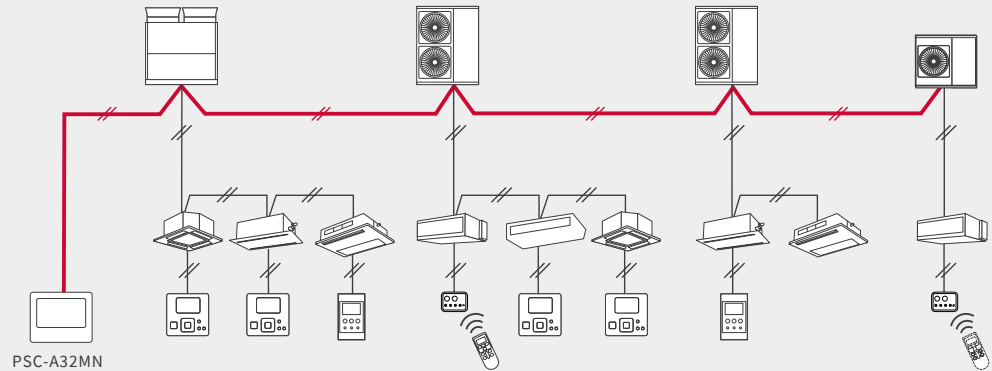

## ADVANTAGES

1. A multi air conditioner for a building and a package air conditioner for a store or office. It can be used with a home air conditioner.
2. There are no restrictions on the delivery route or order for wiring.
3. Just connect to a terminal block.  
(An adapter and a dedicated connector are not necessary.)

## RECOMMENDED FACILITY (EXAMPLE)



Educational institutions such as primary schools where installation work cannot be performed on weekdays.



Hotels where it is preferable to complete installation work during late evenings.



Rehabilitation facilities or hospitals where it is necessary to minimise the burden on users.

## DEFINITION OF TERMS IN HITACHI CENTRALISED CONTROL SYSTEMS

1. CS-Net/Central Station  
→ Hitachi original central controller
2. RC Group (Remote Controller System Group)  
→ Stands for a number of indoor units (up to 16 units) connected using "same remote controller" wiring. In this group, connected indoor units are all controlled in the same way.
3. Group  
→ Stands for the multiple "RC groups" that are registered in the central controller network setting.
4. Block  
→ Stands for the multiple "groups" that are registered in the central controller network setting.

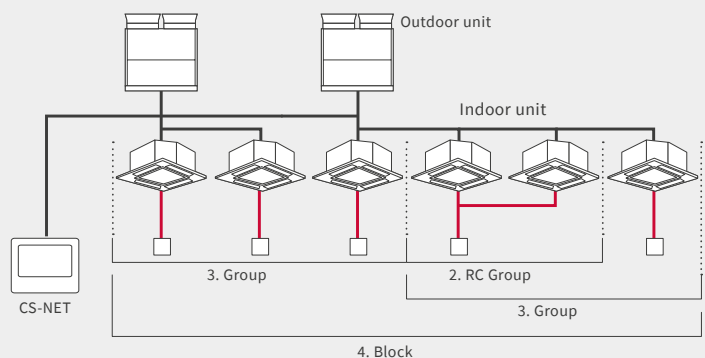

# POINT

## Flexible Wiring Routes

**(1) If indoor units are located in one place and the indoor unit to be controlled is in the room where "Centralised Controller" is installed**

- Overall control is possible by connecting "Centralised Controller" to the indoor unit.
- Delivery distance can be greatly reduced.

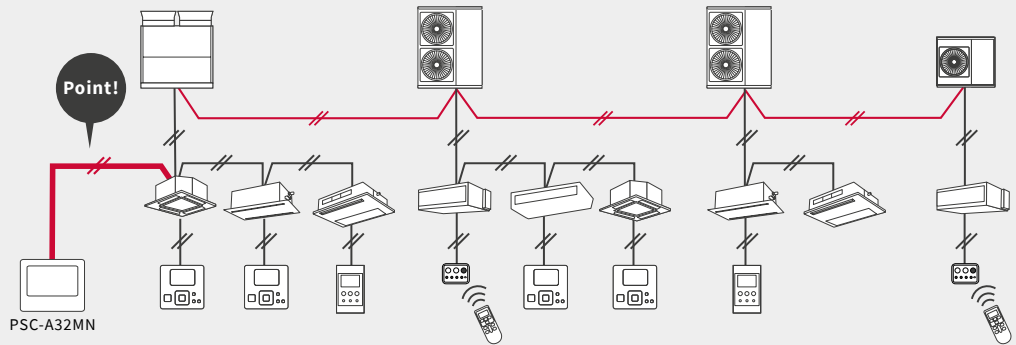

**(2) If indoor units are located in two places and any indoor units of each system are located close together**

- Overall control is possible by connecting part of the indoor units of each system.
- Delivery distance can be greatly reduced.

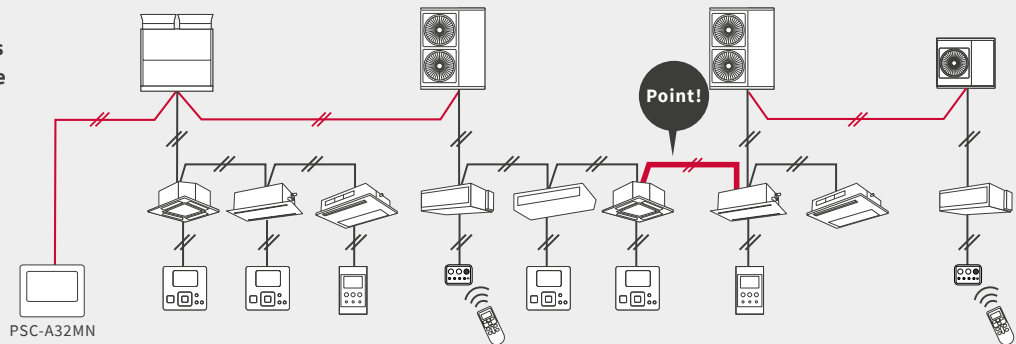

**(3) If two systems are completely separated**

- Overall control is possible by separately connecting the two systems to "Centralised Controller".
- It is possible to select a wiring route based on the wiring distance and the ease of installation.

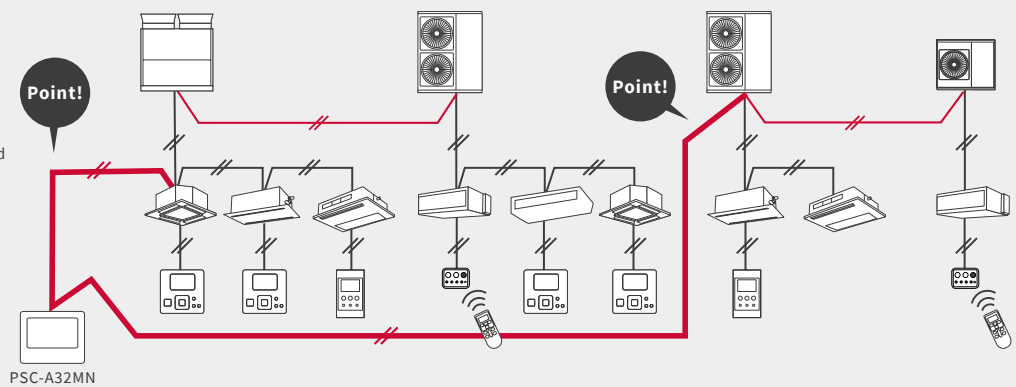

**(4) If indoor units are located discretely**

- Overall control is possible by connecting indoor units.
- Installation is possible through indoor wiring only without outdoor wiring.

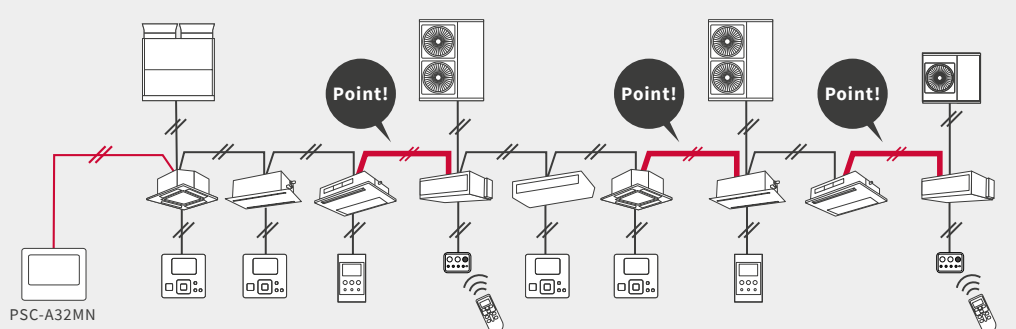

SET FREE mini HNRQ series

H-LINK



**ENQUIRIES**

sales@temperzone.com.au

**AUSTRALIA**

Sydney: (02) 8822 5700  
Melbourne: (03) 8769 7600  
Brisbane: (07) 3308 8333  
Adelaide: (08) 8115 2111

**DISTRIBUTORS**

Newcastle: (02) 4962 1155  
Perth: (08) 6399 5900  
Launceston: (03) 6331 4209

**NEW ZEALAND**

Auckland: (09) 279 5250  
Wellington: (04) 569 3262  
Christchurch: (03) 379 3216



Residential



Commercial

**WARRANTY**

5 year for residential applications only. One year for commercial applications

**hitachiaircon.com.au**

**temperzone.biz**



ISO 9000 series

Shimizu Air Conditioning Headquarters, Professional-Use Air Conditioning Business Division, Johnson Controls – Hitachi Air Conditioning JQA-1084 obtained in November 1995



ISO 14000 series

Shimizu Business Office, Johnson Controls – Hitachi Air Conditioning EC97J1107 obtained in October 1997

The specifications of this catalogue may change without prior notice to allow Hitachi Cooling & Heating to incorporate the latest innovations for its customers. The information contained in this catalogue is merely informative. Hitachi Cooling & Heating declines any responsibility in the broadest sense, for damage, direct or indirect, arising from the use and / or interpretation of the recommendations in this catalogue.