

TA-Smart



Smart valves

2-way control valve with uniquely shaped EQM characteristics with flow, temperature and power measurement capabilities

TA-Smart

The ultrasonic flow measurement technology combined with unique actuation algorithms capabilities provide best-in-class control performances. The TA-Smart controls can be set to flow or power, giving high on-site flexibility and providing highly effective comfort in heating and cooling applications. Its compact arrangement and simple set-up reduces installation and commissioning time.



Key features

- > **Best-in-class control**
Accurate and fast control response even at very low flows in common part load conditions. Ensures full modulating control for the complete operating stroke leading to world class control and efficiencies.
- > **Optional cloud connection**
Easy remote access to data and configuration parameters allows to verify and adjust system performance.
- > **High measurement accuracy**
High flow and temperature measurement accuracies in all configurations (medium type, and temperature) for all flow regimes.
- > **Compactness and limited number of components**
Reduces installation time and space requirements facilitating retrofit installation.
- > **Convenient, reliable setup**
Fully customizable and commissionable using Bluetooth enabled smart device reducing commissioning and diagnostic time.
- > **Easy diagnostics**
Continuous measurement (flow, temperature, power...) enables accurate error identification in system hydraulics.
- > **Versatility in communication**
Digital (key Bus protocols and MQTT) and Analog (0(2)-10 VDC or 0(4)-20 mA).

Technical description

Application:

Heating and cooling systems.

Functions:

Control (flow, power, position)
Pre-setting (max./min. flow, max. power, max./min. position)
Reading (flow, power, energy, supply/return temperature, ΔT , position)
Manual override (via HyTune app)
Mode, status and position indication
Valve blockage protection
Valve clogging detection
Error safe position
Diagnostic
Logging
Delayed start-up

Dimensions:

DN 20-80

Pressure class:

DN 20-50: PN 25
DN 65-80: PN 16, PN 25

Differential pressure (ΔpV):

Max. differential pressure (ΔpV_{max}): 400 kPa = 4 bar
Closing pressure: 600 kPa = 6 bar
 ΔpV_{max} = The maximum allowed pressure drop over the valve to fulfill all stated performances.

Flow range:

The flow ranges (q_{setmin} - q_{nom}) for different dimensions:
DN 20: 380 - 1900 l/h
DN 25: 540 - 2700 l/h
DN 32: 920 - 4600 l/h
DN 40: 1560 - 7800 l/h
DN 50: 2680 - 13400 l/h
DN 65: 5800 - 29000 l/h
DN 80: 8640 - 43200 l/h
Minimum controllable flows ($q_{contr.min}$) 0.5% of q_{nom} .
 q_{setmin} = Minimum settable flow.
 q_{nom} = Maximum settable flow.

Measurement accuracy:

Flow:
 $\pm 3\%$ from 5% to 100% of q_{nom} (see "Flow accuracy")
Temperature difference:
 ± 0.1 K @ $\Delta T = 6$ K (for cooling)
 ± 0.15 K @ $\Delta T = 10$ K (for heating)
 ± 0.2 K @ $\Delta T = 20$ K (for heating)

Control accuracy:

$\pm 5\%$ from 4% to 100% of q_{nom}
 $\pm 10\%$ from 0.5% to 4% of q_{nom}

Temperature:

Max. working temperature: 110°C
Min. working temperature: -10°C
Operating environment: 0°C - +50°C (5-95%RH, non-condensing)
Storage environment: -20°C - +70°C (5-95%RH, non-condensing)

Media:

Water or neutral fluids, water-glycol mixtures (0-57%).

Leakage rate:

DN 20-50: Leakage rate <0.01% of q_{nom} with correct flow direction (Class IV according to EN 60534-4)

DN 65-80: Tight sealing with correct flow direction (Class V according to EN 60534-4)

Characteristics:

Settable: Stepless between EQM 0.25 and inverted EQM 0.25.

Supply voltage:

24 VAC/VDC $\pm 15\%$.

Frequency 50/60 Hz ± 3 Hz.

NOTE: 24 VAC/VDC power supply must be provided only with safety isolating transformer according to EN 61558-2-6.

Power consumption:

DN 20-50:

Operation: < 4.0 W (24 VDC);

< 5.6 VA (24 VAC)

Standby: < 1.9 W (24 VDC);

< 3.3 VA (24 VAC)

DN 65-80:

Operation: < 5.8 W (24 VDC);

< 10 VA (24 VAC)

Standby: < 1.9 W (24 VDC);

< 3.3 VA (24 VAC)

Input signal:

By BACnet/Modbus or Analog signal.

Analog in VDC or mA, selectable by

jumper in the SmartBox;

0(2)-10 VDC, R_i 47 k Ω .

Adjustable sensitivity 0.1-0.5 VDC.

0.33 Hz low pass filter.

0(4)-20 mA R_i 500 Ω .

Proportional:

0-10, 10-0, 2-10 or 10-2 VDC.

0-20, 20-0, 4-20 or 20-4 mA.

Proportional split-range:

0-5, 5-0, 5-10 or 10-5 VDC.

0-4.5, 4.5-0, 5.5-10 or 10-5.5 VDC.

2-6, 6-2, 6-10 or 10-6 VDC.

0-10, 10-0, 10-20 or 20-10 mA.

4-12, 12-4, 12-20 or 20-12 mA.

Proportional dual-range (for change-over):

0-3.3 / 6.7-10 VDC,

10-6.7 / 3.3-0 VDC,

2-4.7 / 7.3-10 VDC or

10-7.3 / 4.7-2 VDC.

Default setting: Proportional 0-10 VDC.

Output signal:

BACnet/Modbus

0(2)-10 VDC, max. 8 mA, min. 1.25 k Ω .

Wireless:

Bluetooth Low Energy (BLE)

Thread

Temperature sensor cable:

DN 20-50: 3 m halogen free

DN 65-80: 5 m halogen free

10 m halogen free cable on request.

Ingress protection:

IP54 (according to EN 60529)

Protection class:

(according to EN 61140)

III (SELV)

Material:

DN 20-50:

Valve body: AMETAL[®]

Valve insert: AMETAL[®]

Valve plug: AMETAL[®] and PTFE

Spindle: Stainless steel

Spindle seal: EPDM O-ring

Internal plastic parts: PPS

Springs: Stainless steel

O-rings: EPDM

Temperature housing: AMETAL[®].

DN 65-80:

Valve body: Ductile iron EN-GJS-400-15

Valve insert: Ductile iron EN-GJS-400-15

and brass

Valve plug: Stainless steel and EPDM

O-ring

Valve seat: Stainless steel

Spindle: Stainless steel

Spindle seal: EPDM

Springs: Stainless steel

O-rings: EPDM

SmartBox (DN 20-80):

Cover: PC/ABS, red.

Housing: PC/ABS, TPE.

Actuators:

DN 20-50:

Cover: PC/ABS GF8, white RAL 9016,

grey RAL 7047.

Housing: PA GF40.

Swivelling nut: Nickel-plated brass.

DN 65-80:

Cover: PBT, orange RAL 2011, grey RAL 7043.

Bracket: Alu EN44200

Cables: Halogen free

AMETAL[®] is the dezincification resistant alloy of IMI Hydronic Engineering.

Surface treatment:

DN 20-50: Non treated

DN 65-80: Electrophoretic painting

Marking:

Valve body:

DN 20-50: IMI TA, PN, DN, inch size,

country of origin and flow direction arrow.

DN 65-80: IMI TA, DN, inch size, material

and flow direction arrow. Label with

technical specification, country of origin

and CE.

SmartBox: IMI TA

Actuator: IMI TA, model, technical spec.,

LED info.

Pipe connection:

DN 20-50: Male thread according to

ISO 228.

DN 65-80: Flanges according to

EN-1092-2, type 21. Face to face length

according to EN 558, series 1.

Certification and directives:

EMC-D. 2014/30/EU: EN 60730-1, -2-14.

Product standards EN 60730-x.

PED: 2014/68/EU

Flow accuracy

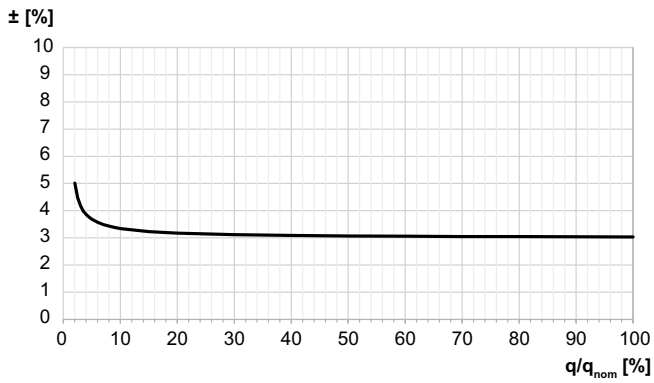

Installation

DN 20-50

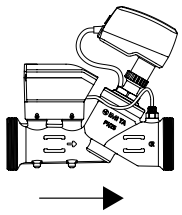

DN 65-80

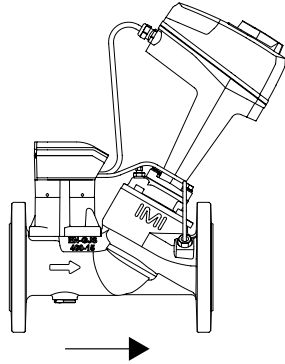

DN 20-50

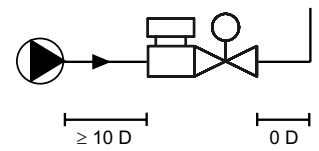
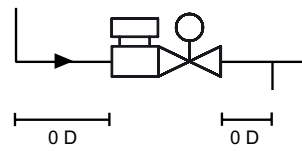

DN 65-80

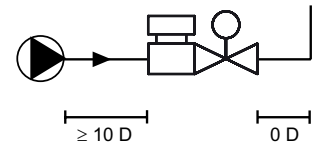
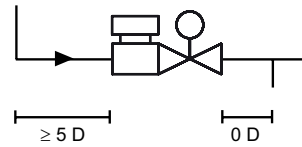

DN 20-50

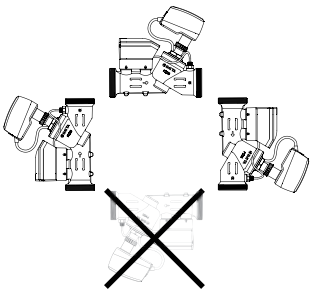

DN 65-80

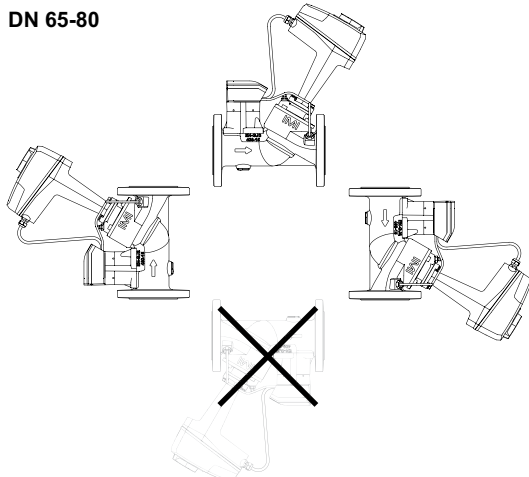

Note: Free space is required above the actuator/temperature pocket for easy mounting/dismounting.

DN 20-50

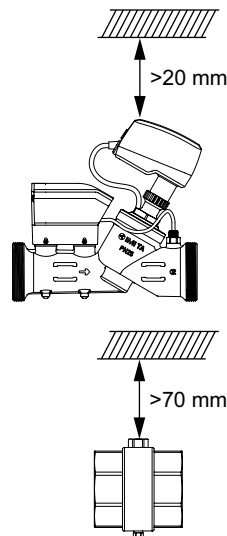

DN 65-80

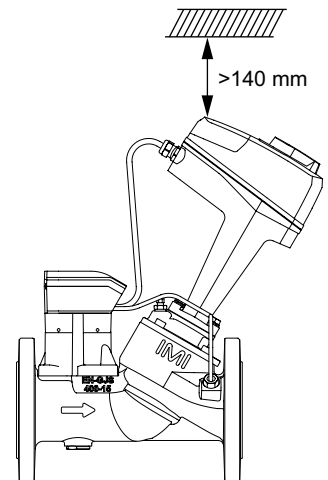

Articles

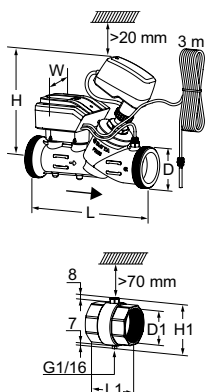

TA-Smart DN 20-50

Including temperature housing and 3 m sensor cable.
(10 m cable on request, please contact IMI Hydronic Engineering)
Male threads according to ISO 228.

DN	D	L	H	W	Kvs	Kg	EAN	Article No
20	G1	180	174	97	3,0	1,6	7318794174207	322231-00020
25	G1 1/4	187	174	97	4,2	1,8	7318794174306	322231-00025
32	G1 1/2	226	223	97	7,28	2,1	7318794164307	322231-00032
40	G2	232	227	97	12,3	3,0	7318794164406	322231-00040
50	G2 1/2	245	235	97	21,3	3,9	7318794164505	322231-00050

Temperature housing incl. temperature pocket

Included in TA-Smart DN 20-50.
Female threads according to ISO 228.

DN	D1	L1	H1
20*	G3/4	60	56
25	G1	62	61
32	G1 1/4	66	70
40	G1 1/2	67	76
50	G2	68	89

*) Can be connected to smooth pipes by KOMBI compression coupling.

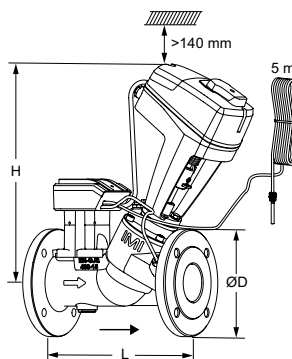

TA-Smart DN 65-80

Including temperature pocket and 5 m sensor cable.
(10 m cable on request, please contact IMI Hydronic Engineering)
Free space >70 mm is required above the temperature pocket.
Flanges according to EN-1092-2, type 21.

DN	Number of bolt holes	D	L	H	Kvs	Kg	EAN	Article No
PN 16								
65	4	185	290	377	50	16,5	7318794171206	322231-01265
80	8	200	310	380	70	18,6	7318794171305	322231-01280
PN 25								
65	8	185	290	377	50	16,5	7318794170803	322231-01365
80	8	200	310	380	70	18,6	7318794170902	322231-01380

→ = Flow direction

Kvs = m³/h at a pressure drop of 1 bar and fully open valve.

Accessories

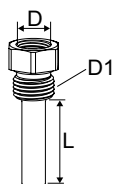

Temperature pocket

Included in TA-Smart DN 65-80.

For mounting directly on pipe. Free space >70 mm is required above the temperature pocket.

Valve DN	D	D1	L	EAN	Article No
20-25	G1/4	G1/4	14	7318794174603	322230-00401
32-80	G1/4	G1/4	30	7318794174009	322230-00400

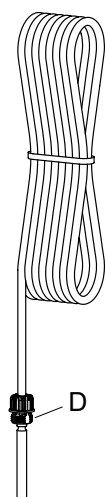

Temperature sensor

Included in TA-Smart (3 m DN 20-50, 5 m DN 65-80).

Length [m]	D	EAN	Article No
3	G1/4	7318794173705	322230-01100
5	G1/4	7318794173804	322230-01101
10	G1/4	7318794173903	322230-01104

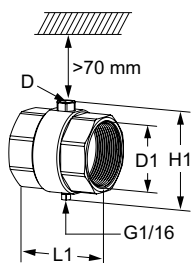

Temperature housing incl. temperature pocket

Included in TA-Smart DN 20-50.

To be ordered separately if the pipe size does not match the valve size.

Female threads according to ISO 228.

DN	D	D1	L1	H1	EAN	Article No
20*	G1/4	G3/4	60	56	7318794174900	322230-00020
25	G1/4	G1	62	61	7318794175006	322230-00025
32	G1/4	G1 1/4	66	70	7318794171404	322230-00032
40	G1/4	G1 1/2	67	76	7318794171503	322230-00040
50	G1/4	G2	68	89	7318794171602	322230-00050

*) Can be connected to smooth pipes by KOMBI compression coupling.

Connections

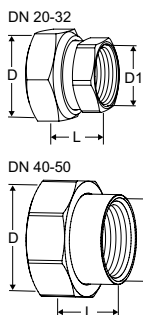

With female thread

Threads according to ISO 228. Thread length according to ISO 7-1. Swivelling nut. Brass/AMETAL®

Valve DN	D	D1	L*	EAN	Article No
20	G1	G3/4	23	7318794017009	52 163-020
25	G1 1/4	G1	23	7318794017108	52 163-025
32	G1 1/2	G1 1/4	31	7318794017207	52 163-032
40	G2	G1 1/2	30	7318794032705	52 163-040
50	G2 1/2	G2	32	7318794032804	52 163-050

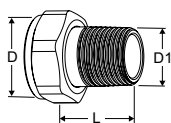

With male thread

Threads according to ISO 7-1. Swivelling nut. Brass

Valve DN	D	D1	L*	EAN	Article No
20	G1	R3/4	32,5	4024052516810	0601-03.350
25	G1 1/4	R1	35	4024052517015	0601-04.350
32	G1 1/2	R1 1/4	38,5	4024052517213	0601-05.350

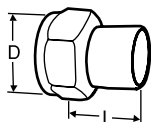

Welding connection

Swivelling nut. Brass/Steel 1.0045 (EN 10025-2)

Valve DN	D	Pipe DN	L*	EAN	Article No
20	G1	20	40	7318792748608	52 009-020
25	G1 1/4	25	40	7318792748707	52 009-025
32	G1 1/2	32	40	7318792748806	52 009-032
40	G2	40	45	7318792748905	52 009-040
50	G2 1/2	50	50	7318792749001	52 009-050

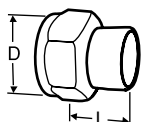

Soldering connection

Swivelling nut. Brass/gunmetal CC491K (EN 1982)

Valve DN	D	Pipe Ø	L*	EAN	Article No
20	G1	18	15	7318792749506	52 009-518
20	G1	22	18	7318792749605	52 009-522
25	G1 1/4	28	21	7318792749704	52 009-528
32	G1 1/2	35	26	7318792749803	52 009-535
40	G2	42	30	7318792749902	52 009-542
50	G2 1/2	54	35	7318792750007	52 009-554

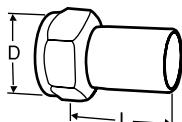

Connection with smooth end

For connection with press coupling. Swivelling nut. Brass/AMETAL®

Valve DN	D	Pipe Ø	L*	EAN	Article No
20	G1	18	44	7318793810700	52 009-318
20	G1	22	48	7318793810809	52 009-322
25	G1 1/4	28	53	7318793810908	52 009-328
32	G1 1/2	35	59	7318793811004	52 009-335
40	G2	42	70	7318793811103	52 009-342
50	G2 1/2	54	80	7318793811202	52 009-354

*) Fitting length (from the gasket surface to the end of the connection).

