

HITACHI

SideSmart™

Variable Refrigerant Flow system
Slim Modular outdoor units
Air source heat pump

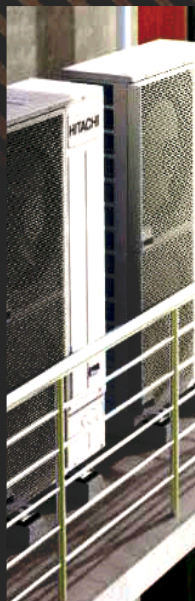

Cooling & Heating

Air. It's a wonderful thing.

Invisible, silent and life-giving, air makes our entire world possible. It surrounds us, continuously energising, cooling and warming.

It can be unpredictable and sometimes challenging, but when air is in harmony with us, everything seems so much easier.

This is our vision. To create the air that makes life better in VRF, exclusive FrostWash™ technology will clean the coil without effort.

Living Harmony

At Hitachi Cooling & Heating, we like to think of this as creating harmony with your interior environment.

When we achieve that wonderful balance, productivity, learning, happiness and health can thrive.

We call this 'Living Harmony' and it's at the centre of everything we do.

The future together

Living Harmony puts people first.

By balancing the human needs of our customers with an uncompromising approach to innovation and quality, we can continue to create the technologies for a more comfortable and balanced world. Your world.

We live in it together.

The beauty of balance

No matter what the weather is like outside, when you're indoors, you want to have complete control over your environment.

At work or play, awake or asleep, you're free to create your own atmosphere; balancing energy with calm, sound with silence and light with shade.

It's the same for cooling and heating. When the air around you is in balance, you can enjoy life indoors that much more.





Index

05
Message

01

06
Outdoor Units

- 08 | The world's first slim modular VRF
- 10 | SideSmart™ : The power of ubiquity
- 12 | Features & Benefits
- 20 | Specifications

02

22
Indoor Units

- 24 | Line-up summary
- 26 | Our key indoor features
- 34 | Solutions
- 43 | Specifications & accessories

03

44
Ventilation

- 46 | Our ventilation line-up
- 48 | DX-kit

04

50
Controllers

- 52 | Centralised controllers
- 58 | Individual controllers
- 64 | Accessories
- 66 | H-LINK: Enjoy more freedom



10

**reasons
to choose
Hitachi VRF**



Worldwide trusted band

Engineered with precision in Japan, Hitachi has been one of the best-selling VRF brands around the world since our first launch in 1983.



HVAC professionals: We care about you

Each of our VRF equipment is carefully designed for ease of installation and maintenance. Piping routes, access to components, condensation management - our products make your job easy!



Advanced features, more comfort for room occupants

From exclusive **GentleCool** temperature control function to 4-way cassettes with individual louvre control, our VRF systems embed various features to enhance the wellbeing of occupants, based on their needs.



Welcome to Central Station

Hitachi Cooling & Heating's best-in-class & acclaimed range of centralised controllers makes VRF system operation easy. Our various **Central Station** models can suit all types of user profiles and system sizes, so that every operator can control and adjust operations as they wish.



SmoothDrive™: patented technology for unique benefits

Our exclusive **SmoothDrive™ VRF compressor control technology** provides unrivaled efficiency and comfort. Our systems meet the most stringent energy efficiency regulatory standards, but they do more than just that. Thanks to SmoothDrive™, you can save more energy during partial load conditions, reflecting the real life usage of VRF systems. When individual indoor units are turned off, the outdoor temperature changes or the indoor temperature reaches an optimal level - SmoothDrive™ provides extra savings and comfort, for which Hitachi VRF was awarded with energy-efficiency prizes in Japan.



airCloud pro, the new generation of VRF monitoring

From your smartphone or web, manage your VRF systems in full simplicity. Operators can select zones and adjust AC operation, or track systems errors remotely. **airCloud Pro** can accommodate an unlimited number of VRF systems and an unlimited number of users.



airCloud Select (COMING SOON)

Thanks to our Selection Software, systems engineers can customise their air conditioning selection for each project. With our training material and **airCloud Select**, professionals can confidently meet their clients' requirements.



A solution for every project

From small shops to skyscrapers, from snowy days to scorchers, there's always a Hitachi VRF solution for you. Our offer provides great flexibility with several options when it comes to: multiple types of outdoor units and indoor units, piping distance, adaptive external static pressure, best-in-class CH-Box choice, along with a variety of controllers for each type of user.



Demand response energy management

Smart cities, smart buildings... and smart Hitachi VRF systems! Discover our two advanced power-saving functions: peak-load cut to prevent peak demand, and capacity moderation to reduce the power input demand. In addition, the large majority of our controls provide simplified scheduling capabilities, so that users can schedule to save energy according to their utility plan.

The Complete VRF Solution Select and combine components as needed

Versatile Outdoor units

- Top flow modular (Heat pump & Heat recovery)
- Side flow "mini" (Heat pump)
- SideSmart™ modular (Heat pump)

Variety of indoor units

- Over 30 models available around the globe
- Wide range of ceiling cassettes and ducted units for all types of configuration
- Ventilation
- Air Handling Unit Integration to Hitachi VRF

User-friendly controls

- Central Station: large choice of interfaces for simple centralised control operations
- Individual controllers: various types available
- **airCloud Pro**: cloud-based monitoring available via smartphone app and web

*Product availability varies across countries. Please visit www.hitachiaircon.com.au or contact your local Hitachi Cooling & Heating representative for more information.

Outdoor units

0

1



Striving for innovative VRF technology

Meet SideSmart™, our latest innovation to join the Hitachi VRF family.

Offering unprecedented flexibility and high efficiency, SideSmart will delight HVAC professionals, while it delivers to end-users the comfort they deserve.

08 THE WORLD'S FIRST SLIM MODULAR VRF

10 SIDESMART™ : THE POWER OF UBIQUITY

12 FEATURES & BENEFITS

19 SPECIFICATIONS



**GOOD
DESIGN
AWARD®
WINNER**

2021 Good Design Award, Australia
Product Design
Commercial & Industrial

The world's first slim modular VRF!

SideSmart™ is an exclusive solution, offering until now an unseen combination of benefits: performance equaling large top-flow units, with slim modular units which can fit anywhere.



5 SMART BENEFITS OF SIDE FLOW VRF

CONCEPT

Modularity with great performance

Benefit from the highest level of Hitachi VRF efficiency

DESIGN

Connectable slim side-flow modules

For the first time, side-flow units can be connected to build larger systems

CONFIGURATION

Can be installed on different floors

... thanks to flexible capacities & options for indoor locations.

LAYOUT

Save building space

Reserve your rooftop for other purposes and optimise your indoor layout

INVESTMENT

Cost savings at every stage

Fewer piping runs, a simplified installation and energy-saving operation.



Single Cabinet	HP	8	10	12	14	16	
Dimensions (H x W x D)	mm	1,650 x 1,050 x 420			1,650 x 1,190 x 420		
Net Weight	380-415V	kg	185	197	203	219	225
	220V	kg	188	200	205	223	231
Cooling Capacity		kW	22.4	28.0	33.5	40.0	45.0
Heating Capacity		kW	25.0	31.5	37.5	45.0	50.0
Performance	EER (Cooling)		4.51	4.26	4.27	3.85	3.79
	COP (Heating)		4.92	4.44	4.68	4.40	4.41
Air Flow Volume		(m ³ /min)	160	185	200	250	258
Noise level dB(A)	SPL ¹ (Cooling/Heating)	dB(A)	55/56	59/60	60/62	60/61	62/64

*1 SPL is measured by an anechoic room, so that reflected sound should be taken into consideration in the field.



Key Features

3 PATENTS

A true innovation from Hitachi, only achieved using the flexibility and efficiency of SideSmart:

- Round shaft motor clamp
- Tandem sub cooling system
- Heating rapid start technology

MULTIPLE MODULES

Combine and connect up to 4 outdoor units to build larger systems

-13% REFRIGERANT CHARGE

A lower amount of refrigerant is required compared to our Hitachi VRF systems with top-flow outdoor units.

UP TO 500M OF PIPING

SideSmart adapts to your building's layout, with up to 500m of total piping runs and up to 120m between outdoor and indoor units. Up to 150m equivalent piping length between the outdoor and indoor unit.

PRESERVE ROOFTOP SPACE

By installing SideSmart on individual floors of a building, your rooftop will be free of air conditioning equipment, allowing use for other purposes.

EXTRA SAVINGS AT <40% PART-LOAD

Hitachi exclusive SmoothDrive™ micro-precision technology boosts energy efficiency during part-load operation, to meet real life conditions.

UP TO 152kW

With our various modules, SideSmart offers a vast array of capacities.

SLIMLINE FOOTPRINT

SideSmart modules are only 42cm deep, providing you with added flexibility to fit within the narrowest of spaces.

HIGH EFFICIENCY

SideSmart™ delivers the same astonishing level of energy savings as the largest VRF systems:

- Single cabinet COP up to 4.40
- EER 3.52 / COP 3.90 average for Premium

The power of ubiquity, Anywhere and everywhere.

Thanks to its slim modular design, SideSmart offers unrivaled flexibility of installation location. Save your building's most valuable area, and place SideSmart™ in the small narrow spaces of your building. On the rooftop, balcony, or indoors; you choose!

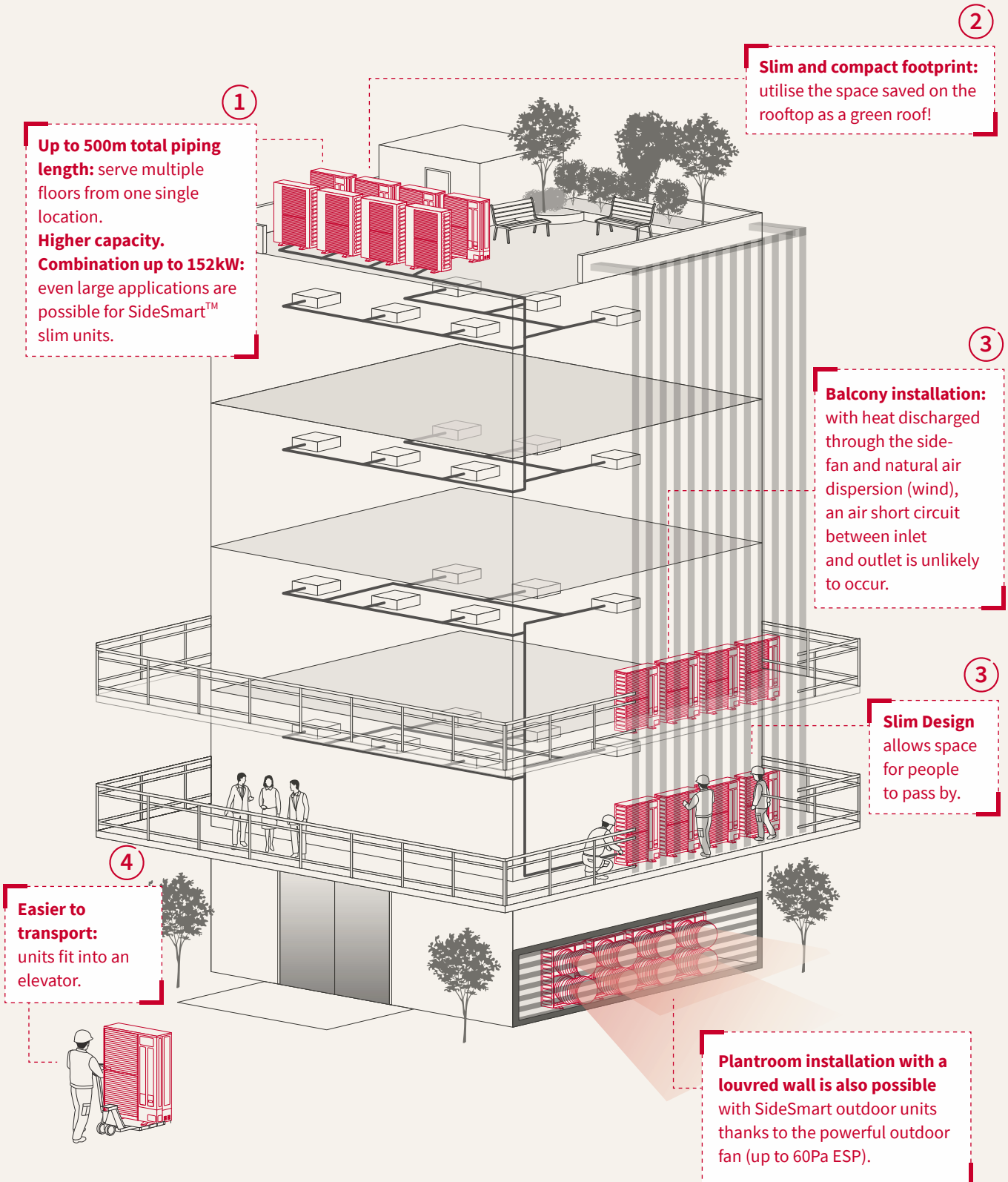

DISCOVER THE ADVANTAGES OF SIDESMART

1 SideSmart requires fewer pipes

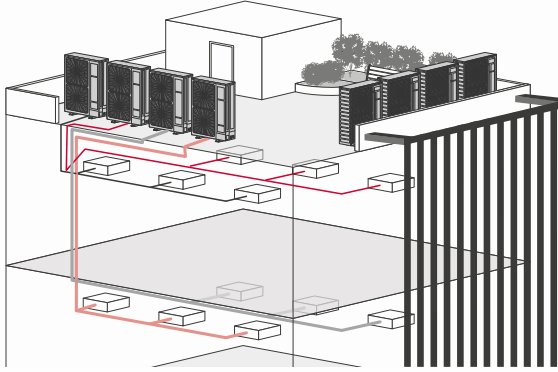

Compared with: conventional side-flow VRF.
Because multiple outdoor units can be combined to one piping system, less refrigerant piping is needed.

2 SideSmart saves space

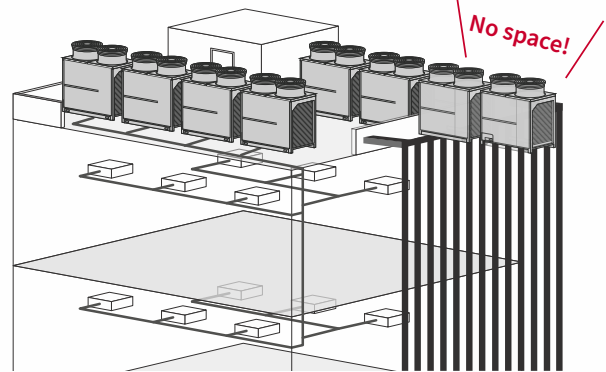

Compared with: conventional top-flow VRF.
Thanks to the smaller footprint, less floor space is required

3 When installed on the balcony, since the air comes out to the front of SideSmart, air short circuits are unlikely to occur.

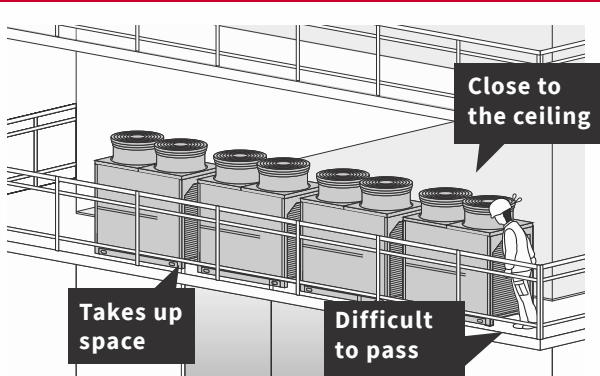

Compared with: conventional top-flow VRF.
The cabinet is too large. People cannot walk around them on a balcony. Air short circuits are likely to occur, because the air discharge is too close to the ceiling.

4 SideSmart is a size that can be transported through an elevator.

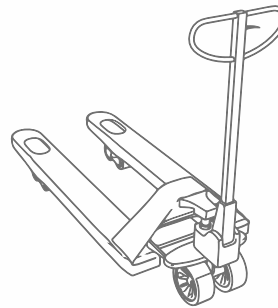

Compared with: conventional top-flow VRF.
Due to the compact and light-weight design, the outdoor units can be easily transported and located to the plant area.

Ideal for extensions: complement your existing VRF system with SideSmart™.

If only narrow space remains to extend to an existing top-flow system, SideSmart™ is the ideal solution.

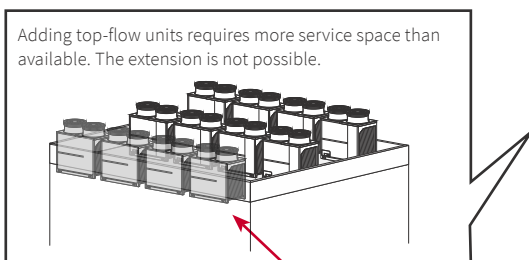

New extension with SideSmart VRF

Existing top-flow VRF

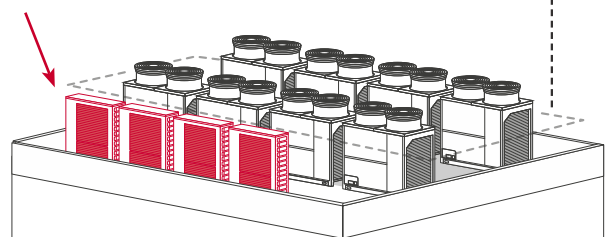

Inadequate space

Features & benefits

Flexibility: meet your project requirements

GREATER PIPING FLEXIBILITY

- Suitable for medium-size buildings or complex facilities.
- Leads to cost and time saving for designers, with improved system design efficiency.

			MARK
Maximum Piping Length	Total	m	500*
	From (Piping Connection Kit 1) to the furthest IDU	m	120 (Actual) L1
		m	150 (Equivalent)
	Between (Piping Connection Kit 1) and each ODU	m	10 La, b, c, d
Maximum Height Difference	Between (First Branch) and the furthest IDU	m	90** L2
	Between each (Multi-Kit) and each IDU	m	40*** L3
	Between ODUs	m	0.1 H5
	Between ODU and IDU (ODU above IDU)	m	50 H1
	Between ODU and IDU (IDU above ODU)	m	40
	Between IDUs	m	30 H2

For single unit, and 2 and 3 unit combinations

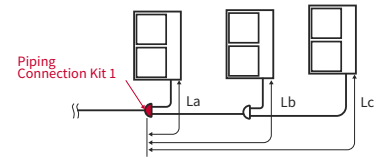

For 4 unit combination

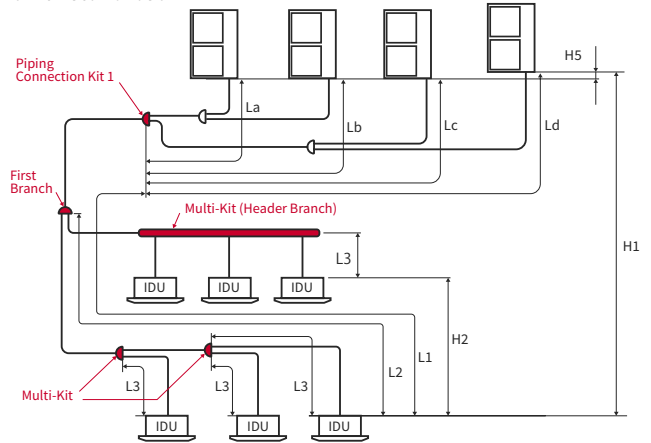

* 500m if at or below the recommended number of fan coil units. 300m if above the recommended number of fan coil units.
 ** 90m if at or below recommended number of fan coil units. 40m if above the recommended number of fan coil units.
 *** **40M IF AT OR BELOW THE RECOMMENDED NUMBER OF** fan coil units. 30m if above the recommended number of fan coil units.

ESP: FLEXIBLE INDOOR INSTALLATION

SideSmart can be installed on each floor (e.g. on balconies or behind a louvred wall) thanks to the powerful outdoor fan that is capable of up to 60Pa ESP.

- Effective heat discharge to the outside is ensured.
- SideSmart units are completely invisible from the building facade.

Equipment balcony

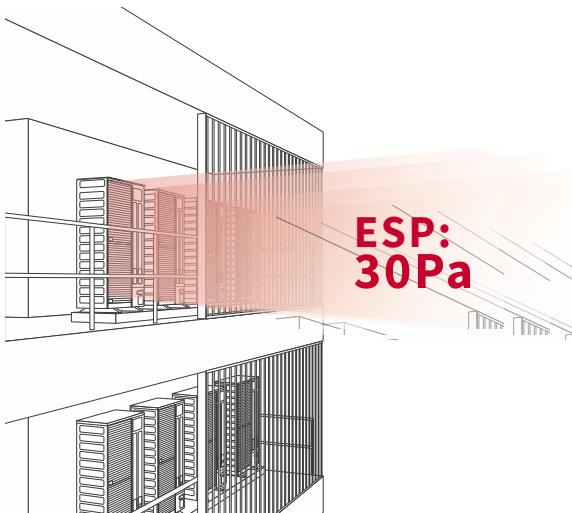

Installation room

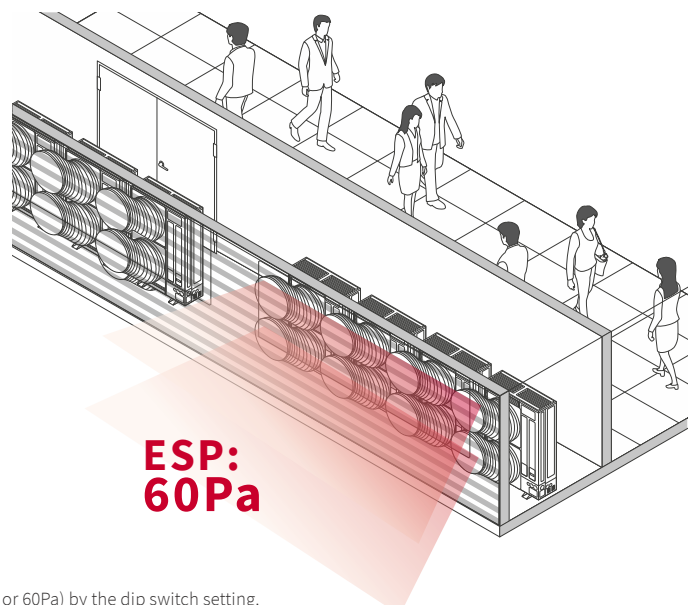

Note: factory default is 0Pa, 2-step additional static pressure can be selected (30Pa or 60Pa) by the dip switch setting.

SLIM FOOTPRINT

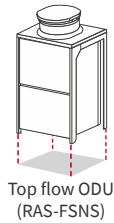

Top flow ODU (RAS-FSNS)

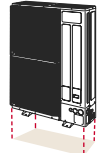

SideSmart™

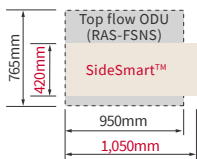

-40% footprint!
RAS-120HNCLEW

Installation examples:



On balconies

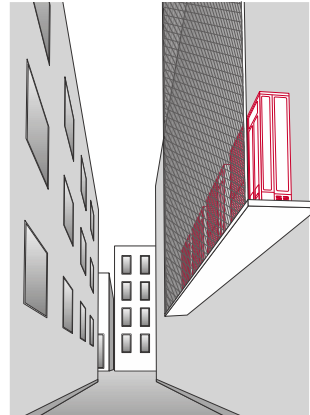

Along building facades (with support structure)

FOR ALL CLIMATES

Cooling operation from up to 52°C ambient temperature

- Stable running up to 48°C
- Interval running up to 52°C

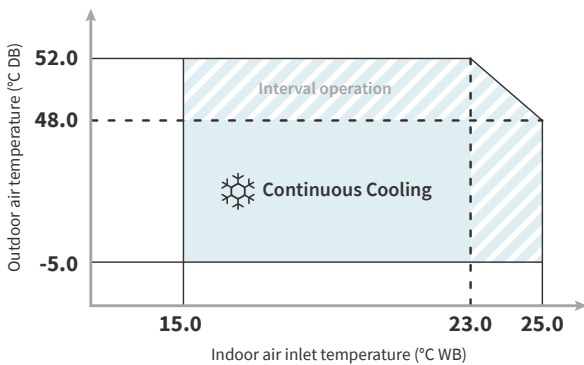

Heating operation from as low as -20°C ambient temperature

- Stable running from as low as -15°C
- Interval running from as low as -20°C

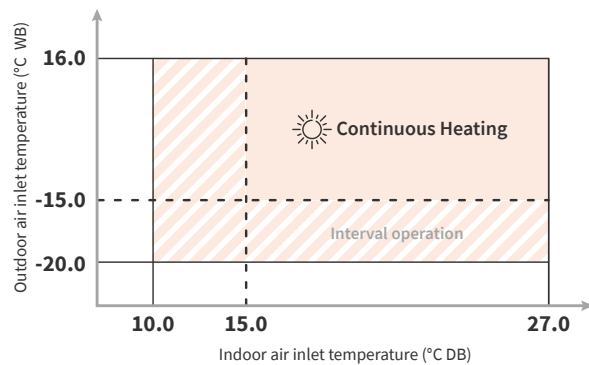

airCloud Select (Coming Soon) Building solutions

airCloud Select* is the latest software selection program, developed by Hitachi to help with designing your next commercial VRF project.

- Enjoy a super intuitive and modern interface
- Easily select the suitable VRF equipment for each project
- Generate automatic & simplified reports for your customers

airCloud Select is available upon request. Availability varies per country. For more information, please contact your local Hitachi Account Manager.

Note: for PC/laptop usage.

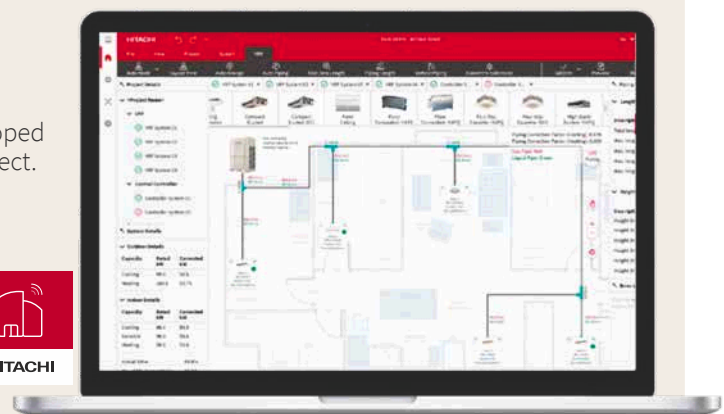

Features & benefits

Small size, yet maximal efficiency

SIDESMART™ OFFERS SUPERIOR EFFICIENCY

Cooling EER up to 3.67

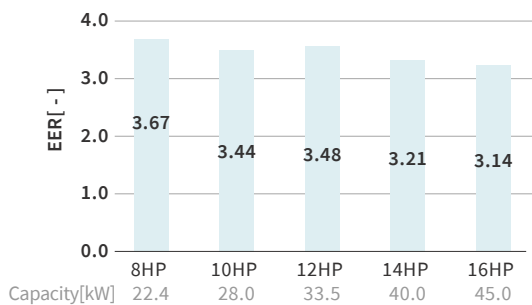

Heating COP up to 4.40

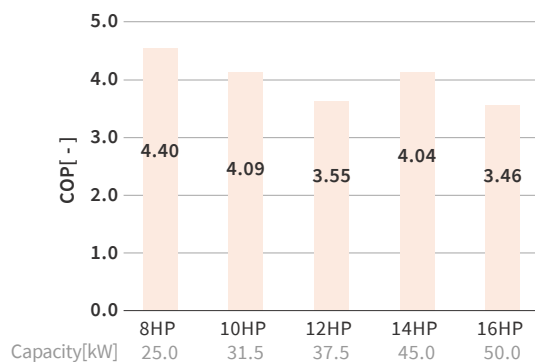

Notes:

1. EER and COP does not include Indoor unit power consumption.
2. This performance is achieved by 4 way cassette combination. For more details about IDU specifications, please refer to the Technical Catalogue.
3. Above ratio is on single cabinet (standard combination & economy combination).

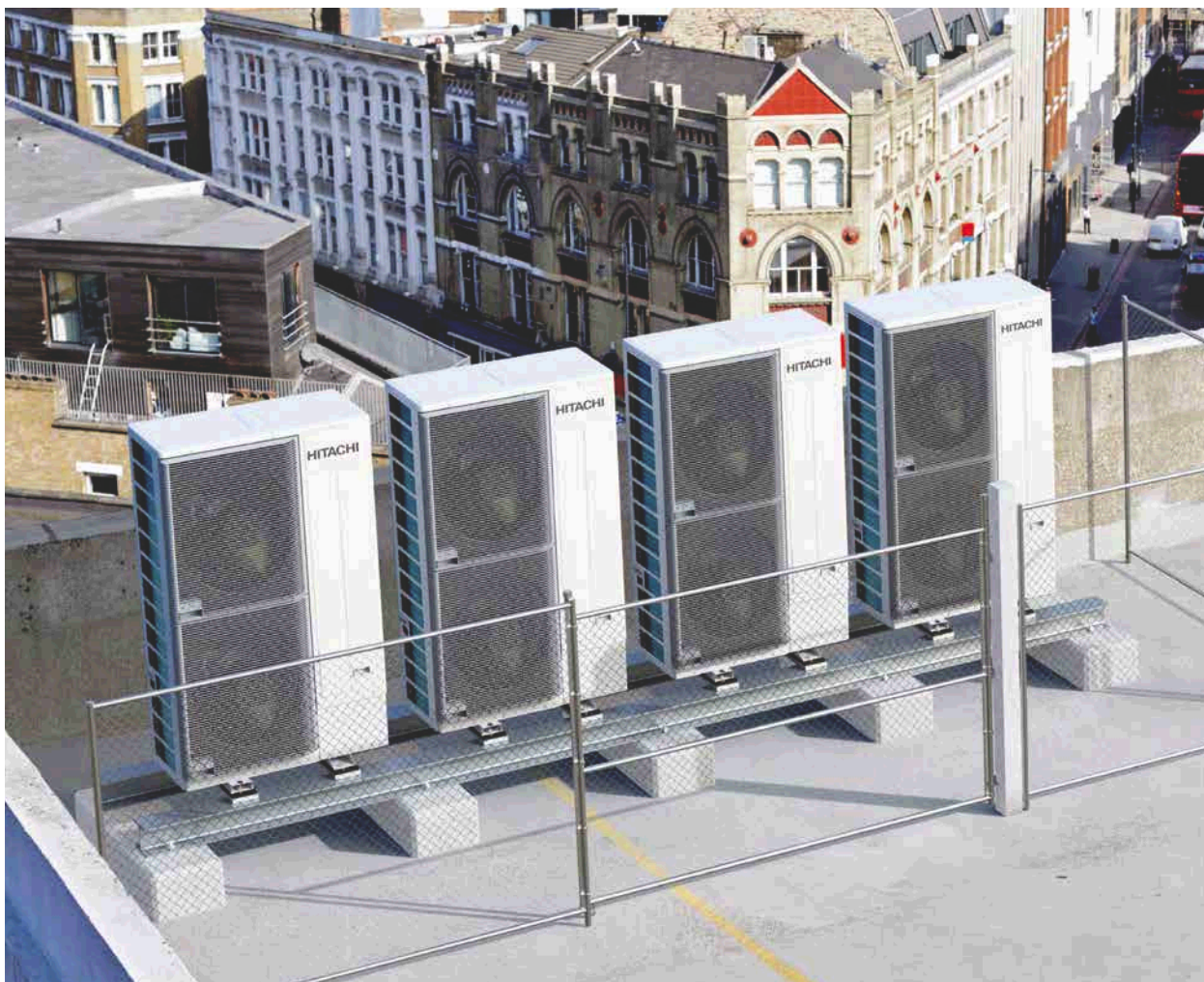

Features & benefits

Improved operation

SMOOTHDRIVE™: SUPERIOR COMPRESSOR CONTROL

We want to bring true value to your customers. Meeting high energy efficiency standards is one thing, but additionally, SmoothDrive supports energy savings in real-life conditions, as our individual lifestyles change constantly.

How does SmoothDrive work?

Building on existing variable evaporating/condensing temperature control, SmoothDrive directly regulates refrigerant amount mass-flow, thanks to Hitachi's original load-speculation technology.

- SmoothDrive helps the scroll compressor to run continuously and smoothly even at part-load condition, resulting in a more stable indoor temperature.
- Our original load-speculation technology helps reduce energy loss caused by scroll compressor switching on/off.
- Consequently, constant room temperature & energy savings can be achieved.

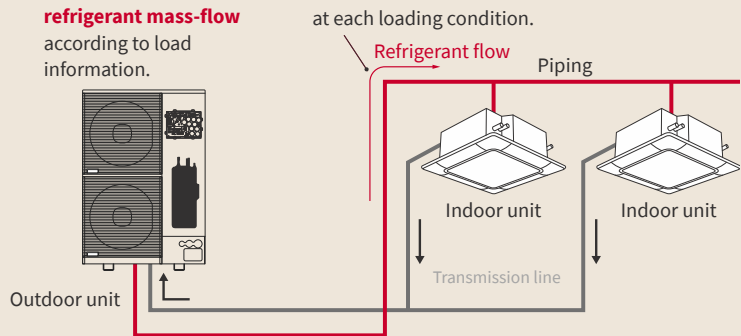

Actual new compressor control example (at 33% part load in cooling operation)

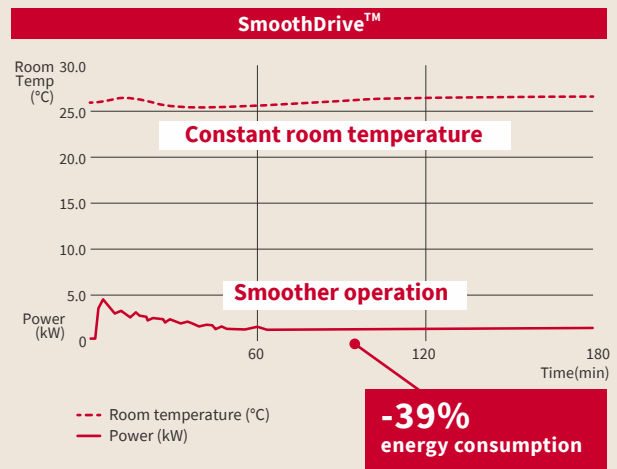
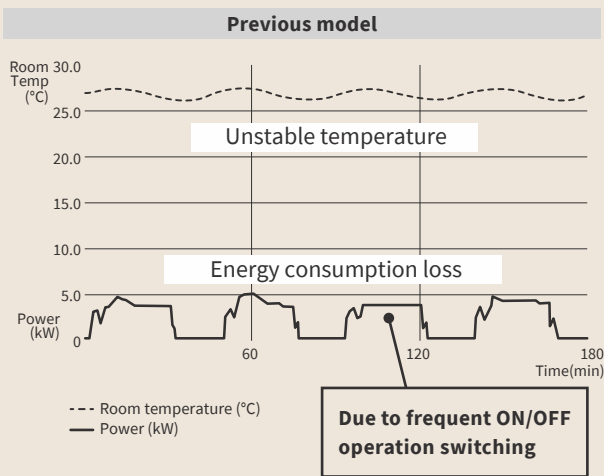

Simulation result for all load conditions

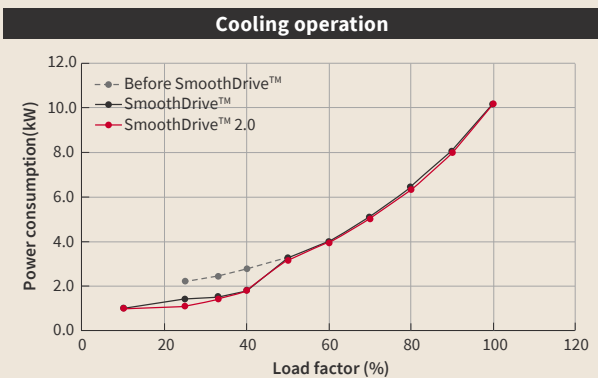

- Difference in power consumption versus load factor.
- Power consumption is reduced when the load factor is 40% or less (note: 40% break point could be changed for different indoor space/thermal inertia).
- The effect of SmoothDrive™ 2.0 Control is only seen at load levels greater than 10% of loading factor.

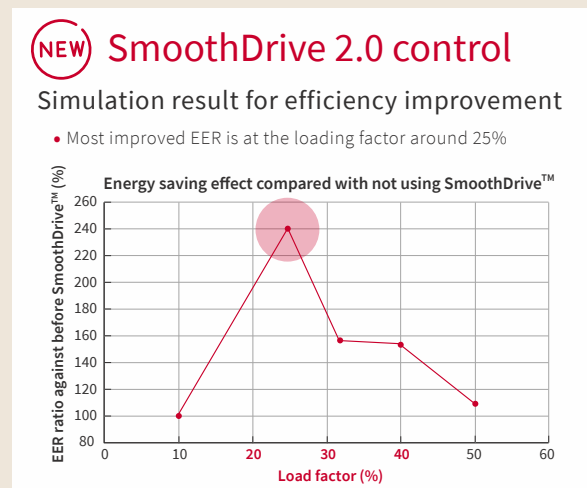

Note: All graphical data above is sourced from Hitachi top flow VRF (RAS-FSNP), incorporating the same SmoothDrive™ technology as SideSmart.

Features & benefits

Reliability: enjoy peace of mind

Piping options in 4 directions

Depending on the installation situation, installers can choose from 4 running pipe direction options.

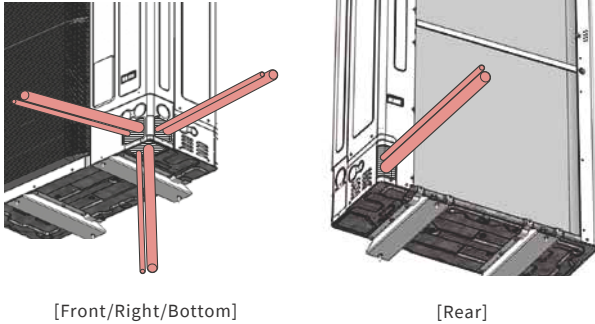

Easier removal of front service cover

The screws you need to open/close the front service cover are all on the front side.

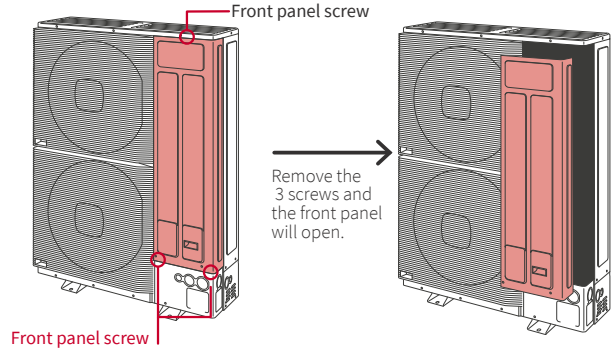

BACKUP OPERATION FEATURE FOR EMERGENCIES

When 2 or more modules are combined:

In the unlikely event that one module in a multi-module system breaks down, the system can be set to operate in an emergency mode, allowing the other unaffected units to continue operating, delivering uninterrupted cooling or heating.

An alarm is triggered and emergency operation can be activated via an individual remote control.

Note: Emergency Mode can be activated up to eight hours after a unit fault. Once eight hours have elapsed, the emergency mode cannot be activated.

Even if one unit fails, the others continue to operate continuously.*

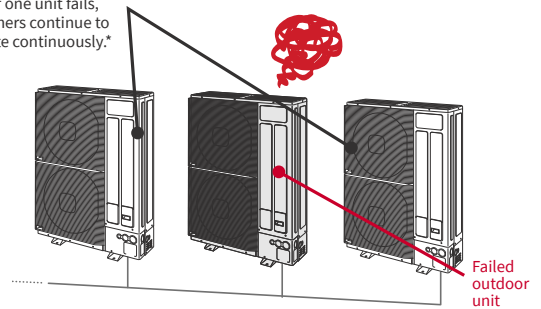

ROTATIONAL OPERATION TO DISTRIBUTE OUTDOOR UNITS LOAD

Regulating the operation time of each outdoor unit¹ leads to extending the life of the system greatly.

During multiple unit operation, maintaining the same rotation frequency of the compressors results in an equivalent load on each compressor, thereby helping enhance outdoor unit durability.

Example 1. Compressor rotation frequency control

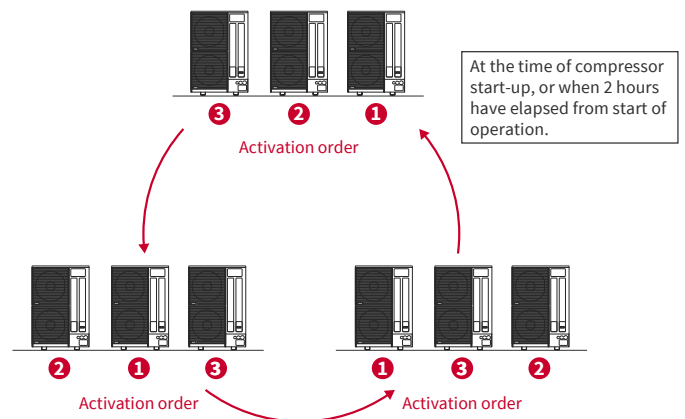
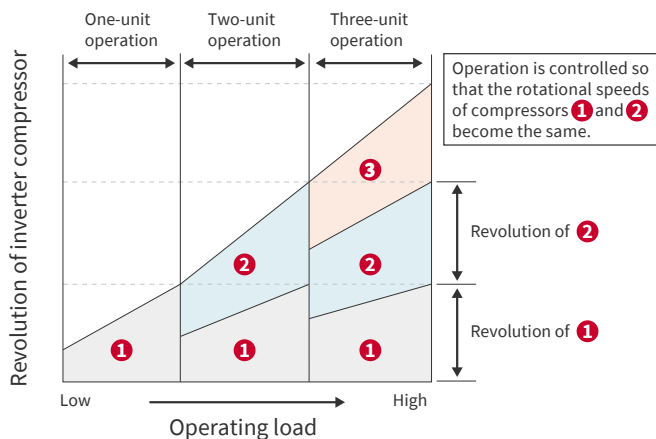

*1 At least 2 outdoor units are required for this function.

*2 Comparison between the rotation operation function and non-rotation operation function based on the same system.

Connect SideSmart™ to
airCloud Pro and monitor
your VRF system from anywhere.

Learn more about airCloud Pro controls on pages 89-90.



For stand-alone
and multi-site
applications.

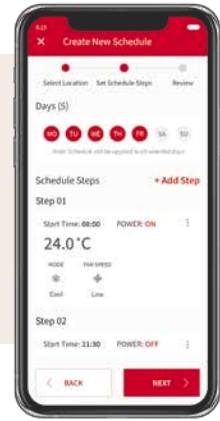

Features & benefits

Improved components

NEW DESIGN OF OUTDOOR UNIT COMPONENTS

NEW! designed grille

Based on Hitachi's Cooling & Heating Duality Design™, the sleek graphite-coloured grille visually blends in, which is ideal for open-space installations.

NEW! motor-clamp

An upgraded design improves the air discharge process, leading to improved efficiency.

NEW! printed circuit board

With Hitachi's exclusive SmoothDrive Compressor Control Technology, operation is more comfortable and consistent.

NEW! Heat exchanger

Features a newly improved refrigerant path and a new fin shape, used in tandem with a subcooling system.

NEW! fan outlet structure

for increased energy efficiency.

NEW! fan,

improved interface between the outside air and the VRF system, is optimised for larger unit capacity by DC fan motor.

Bigger capacity and slimmer unit is made possible by an Hitachi DC-Inverter scroll compressor (with 0.1Hz precision control) and a longer accumulator with greater volume.

LESS REFRIGERANT

Enjoy Hitachi's VRF performance with smaller amounts of refrigerant, thanks to the new tandem subcooling system leading to improved heat exchange.

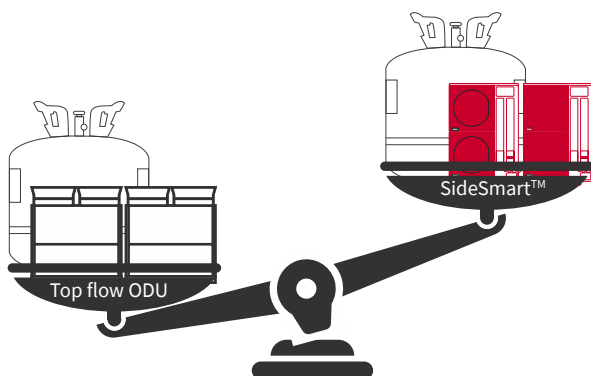

Total refrigerant quantity SideSmart™ vs other VRF

System	Current top flow VRF (RAS-FSNS)	SideSmart™
Initial charge	9.9kg	9.6kg
Additional charge	19.8kg	16.3kg
Total	29.7kg	25.9kg

-13% refrigerant used!

System assumption

System	16HP system
Maximum piping length (from [Piping Connection Kit 1] to furthest indoor unit)	90m
Total piping length	165m
Number of indoor units	3HP Indoor Units * 6 pcs
IDU connection ratio	113%



Specifications

SINGLE CABINET (STANDARD MODEL)

HP			8HP	10HP	12HP	14HP	16HP
Model Name			RAS-080HNCLEW	RAS-100HNCLEW	RAS-120HNCLEW	RAS-140HNCLEW	RAS-160HNCLEW
Power Supply	V/Ph/Hz		380-415V/3Ph/50Hz, 380V/3Ph/60Hz (R: 220V/3Ph/60Hz)				
Capacity	Cooling	kW	22.4	28.0	33.5	40.0	45.0
	Heating	kW	25.0	31.5	37.5	45.0	50.0
Power Input	Cooling	kW	6.11	8.13	9.64	12.45	14.32
	Heating	kW	5.68	7.70	10.55	11.15	14.46
Efficiency	EER		3.67	3.44	3.48	3.21	3.14
	COP		4.40	4.09	3.55	4.04	3.46
Max. Current	415V/3Ph/50Hz	A	18	21	27	32	36
Dimensions	H×W×D	mm	1650×1050×420	1650×1050×420	1650×1050×420	1650×1190×420	1650×1190×420
Net Weight		kg	185	197	203	219	225
Outdoor Unit Colour		—	Natural Gray (1.0Y 85/0.5)	Natural Gray (1.0Y 85/0.5)	Natural Gray (1.0Y 85/0.5)	Natural Gray (1.0Y 85/0.5)	Natural Gray (1.0Y 85/0.5)
Footprint Area		m ²	0.53	0.53	0.53	0.60	0.60
Compressor type		—	Inverter Scroll	Inverter Scroll	Inverter Scroll	Inverter Scroll	Inverter Scroll
Refrigerant	Type	—	R410A	R410A	R410A	R410A	R410A
	Initial Charge Amount	kg	6.0	7.7	7.7	8.3	9.6
Number of Fan Motors		—	2	2	2	2	2
External Static Pressure of Fan	Pa		0/30/60	0/30/60	0/30/60	0/30/60	0/30/60
Capacity Ratio of IDU/ODU		—	50% - 130%	50% - 130%	50% - 130%	50% - 130%	50% - 130%
Sound Pressure Level	GB Standard (Anechoic), Cooling	dB(A)	55	59	60	60	62
	GB Standard (Anechoic), Heating	dB(A)	56	60	62	61	64
Main Piping Size	Liquid	(φ)mm	9.52	9.52	12.70	12.70	12.70
	Gas	(φ)mm	19.05	22.20	25.40	25.40	28.58
Connectable IDU Number	Recommended	-	8	10	10	16	16
	Maximum	-	13	16	19	23	26
Working Temp. Range (*5)	Cooling	°C DB	-5 ~ 48 (/52)	-5 ~ 48 (/52)	-5 ~ 48 (/52)	-5 ~ 48 (/52)	-5 ~ 48 (/52)
	Heating	°C WB	(-20)-15~16	(-20)-15~16	(-20)-15~16	(-20)-15~16	(-20)-15~16
Maximum Piping Length (*6)	Total	m	500 (300)	500 (300)	500 (300)	500 (300)	500 (300)
	From Piping connection kit 1 to Furthest IDU	m	120/150 (Actual/Equivalent)	120/150 (Actual/Equivalent)	120/150 (Actual/Equivalent)	120/150 (Actual/Equivalent)	120/150 (Actual/Equivalent)
	Between Outdoor Units	m	10	10	10	10	10
	Between 1st branch and the furthest IDU	m	90 (40)	90 (40)	90 (40)	90 (40)	90 (40)
	Between each branch and each IDU	m	40 (30)	40 (30)	40 (30)	40 (30)	40 (30)
Maximum Height Difference (*7)	Between ODUs	m	0.1	0.1	0.1	0.1	0.1
	Between ODU and IDU (ODU above IDU)	m	50	50	50	50	50
	(IDU above ODU)	m	40	40	40	40	40
	Between IDUs	m	30	30	30	30	30

Notes:

1. The Cooling and Heating performances are to AS/NZS 3823.1.4 2012

2. The sound pressure is based on the following conditions.

The above data was measured in an anechoic chamber so that reflected sound should be taken into consideration in the field.

3. Sound pressure level data was measured at rated cooling and heating condition which same as performance measurement condition. If working condition is different against rated condition, sound may increase.

4. If set to the high static mode, since the fan rotation speed will be increased, sound may increase 5 to 7 dBA.

(*5) The (XX*) limit temperature applies to interval air conditioning operation.

(*6) In case of connecting number of indoor unit is less than recommended connectable IDU & (when connecting more than recommended number of indoor units).

(*7) In case of connecting number of indoor unit is less than recommended connectable IDU.

8. Efficiency values will differ depending on type, size and quantity of fan coil units connected



From 22.4kW to 152kW: large choice of combinations

Standard combination

kW	RAS-080	RAS-100	RAS-120	RAS-140	RAS-160
22.4	●				
28		●			
33.5			●		
40				●	
45					●
50.4	●	●			
56		●●			
61.5		●	●		
67			●●		
73.5			●	●	
80				●●	
85				●	●
90					●●
96		●●		●	
101.5		●	●	●	
107			●●	●	
113.5			●	●●	
120				●●●	
125				●	●●
130				●	●●
135					●●●
141.5		●	●	●●	
147			●●	●●	
152			●●	●	●

Premium combination

kW	RAS-080	RAS-100	RAS-120	RAS-140
44.8	●●			
50.4	●	●		
55.9	●		●	
61.5		●	●	
67.2	●●●			
72.8	●●	●		
78.3	●●		●	
83.9	●	●	●	
89.4	●		●●	
95		●	●●	
100.5			●●●	
106.3	●●	●	●	
111.8	●●		●●	
117.4	●	●	●●	
122.9	●		●●●	
128.5		●	●●●	
134			●●●●	

—
**Indoor
units**

02



Comfort first

Each space has its own indoor unit. Our wide range of units can meet any type of requirement and space layout, harmonising with the interior decor.

The seamless and quiet operation of the units, allows users to appreciate premium comfort at low operating costs. Advanced functions such as GentleCool and AutoBoost allow you to customize the air within each space to suit your clients preferences, while smart design minimises the need for regular maintenance.

24 LINE-UP SUMMARY

26 OUR KEY INDOOR FEATURES

34 SOLUTIONS

34 Ducted units

High ESP [RPI-FSR, RPI-FSN1] (DC) **NEW**
Medium ESP [RPIM-FSR] (DC) **NEW**
High ESP [RPIH-HNAUNQ, RPI-FSNQ] (AC)
Compact [RPIZ-HNDTSQ] (DC)
Compact [RPIZ-HNATNQ] (AC)
Larger air volume [RPI-FSN2SQ] (AC)

36 Ceiling cassettes **NEW**

Silent-Iconic™ (4-way cassette design panel)
4-way cassette [RCI-FSRP] (DC)
4-way compact cassette [RCIM-FSRE] (DC)
2-way cassette [RCD-FSR] (DC)
1-way cassette [RCS-FSR] (DC)

42 Other indoor units

Wall mounted [RPK-FSRM, RPK-FSRHM] (DC) **NEW**
Floor/Ceiling convertible [RPFC-FSNQ] (AC)
Ceiling suspended [RPC-FSR] (DC) **NEW**
Floor exposed [RPF-FSN2E] (AC)
Floor concealed [RPF-FSN2E] (AC)
Floor concealed [RPF-FSNQ] (AC)



Line-up summary

Over 20 types available!

DUCTED | The ultimate invisibility

NEW

HIGH ESP (DC)

RPI-FSR, RPI-FSN1



NEW

MEDIUM ESP (DC)

RPIM-FSR



COMPACT (DC)

RPIZ-HNDTSQ



HIGH ESP (AC)

RPIH-HNAUNQ, RPI-FSNQ



COMPACT (AC)

RPIZ-HNATNQ



LARGER AIR VOLUME (AC)

RPI-FSN2SQ



new

CASSETTE | Provides a consistent balance of air to all corners of a room

4-WAY CASSETTE (DC)
RCI-FSRP



TWIN-SENSE SYSTEM
RCI-FSRP+ P-AP160NAE2



Silent-Ionic™ Design Panel
P-GP160NAP, P-GP160NAPU, P-GP160KAP

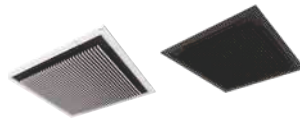

4-WAY COMPACT CASSETTE (DC)
RCIM-FSRE, RCI-FSKDNQ



2-WAY CASSETTE (DC)
RCD-FSR



1-WAY CASSETTE (DC)
RCS-FSR



OTHERS | Minimal installation or retrofit projects

NEW

WALL MOUNTED (DC)
RPK-FSRM, RPK-FSRHM



FLOOR/CEILING CONVERTIBLE (AC)
RPFC-FSNQ



NEW

CEILING SUSPENDED (DC)
RPC-FSR



FLOOR EXPOSED (AC)
RPF-FSN2E



FLOOR CONCEALED (AC)
RPFI-FSN2E



Key Indoor Features

GentleCool

EXCLUSIVE

GENTLECOOL (FOR COOLING OPERATION)



RPI-FSR
RPIM-FSR
RPI-FSN1



RCI-FSRP
(all panels)
RCI-FSKDNQ



RCIM-FSRE



RCD-FSR



RCS-FSR



RPK-FSRM
RPK-FSRHM



RPC-FSR



PC-ARF1



PC-ARFG

GentleCool gives you total control of the air temperature leaving your air conditioner.

It can be set to not only to maintain room temperature, but to increased your comfort levels while doing so.

In the cooling mode, the user can set the level of cooling to avoid any unnecessary cold drafts.

GentleCool might affect the speed of the room's cooling down to the set temperature.

Potential discomfort



GentleCool



GentleCool : no cold draft

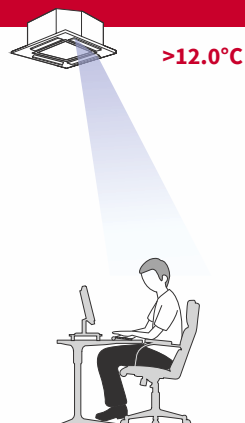

GentleCool



GentleCool

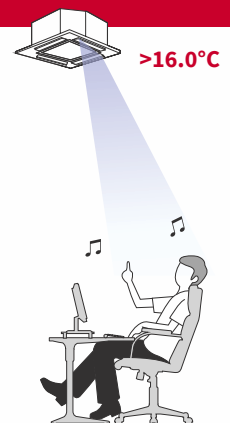

GentleCool



Key Indoor Features

Crowd-Sense

NEW & EXCLUSIVE

CROWD-SENSE: PREDICTIVE ADJUSTMENT TO OCCUPANCY VARIATIONS



Ideal for meeting rooms, restaurants, museums and other venues with fluctuating occupancy.

RCI-FSRP
+
P-AP160NAE2

Using Hitachi's Twin-Sense cassette fascia, the CrowdSense predictive control function senses the change in occupancy and rapidly adjusts the performance of the unit to constantly maintain the desired optimum room temperature.



PC-ARFG

Crowd-Sense action during cooling

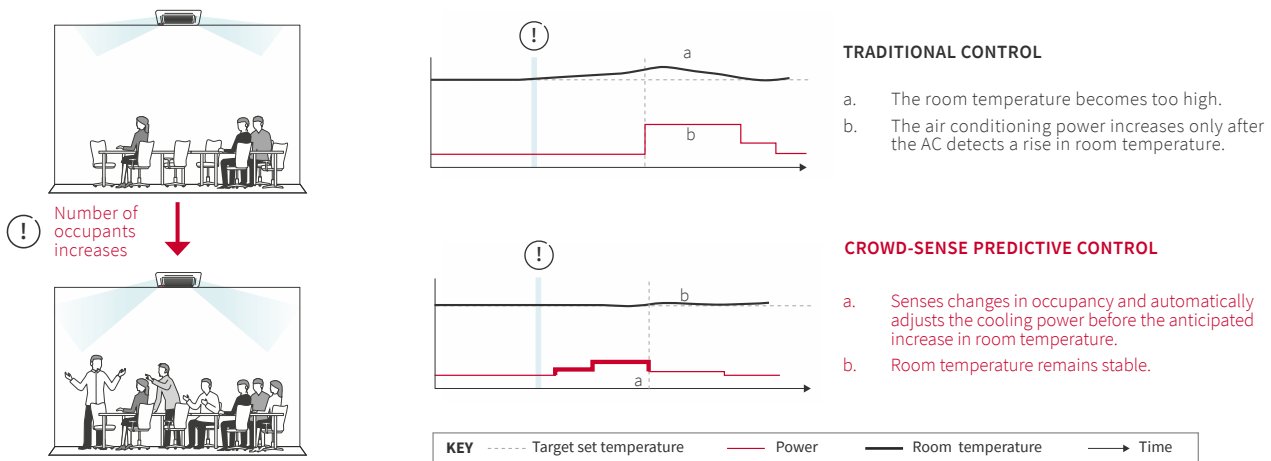

VARIABLE REFRIGERANT FLOW SYSTEM

SideSmart™

Crowd-Sense action during heating

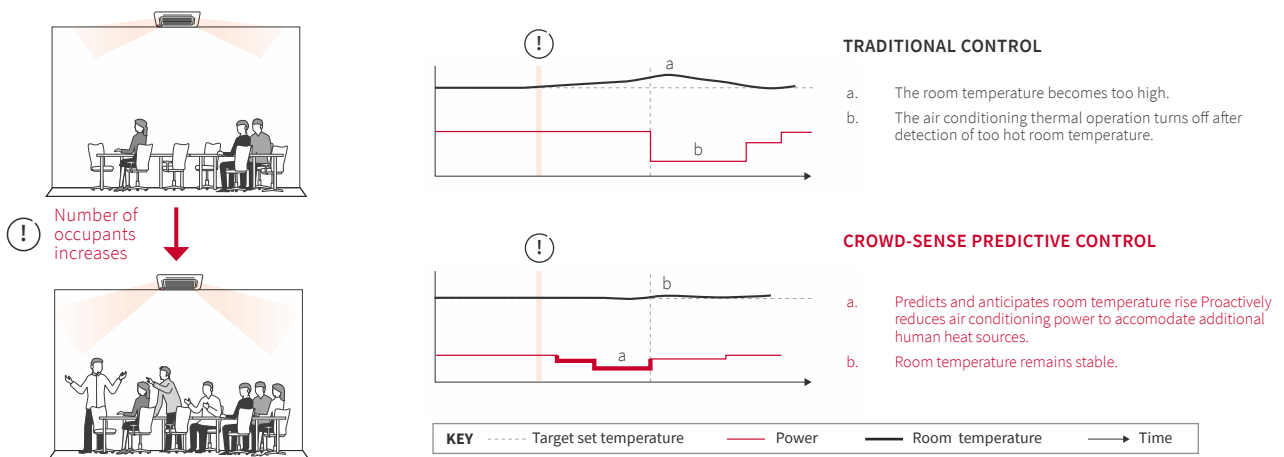

Crowd-Sense may not be effective or might be less effective in the following cases:

- Multiple indoor units are in operation in the same zone.
- The difference between the radiant temperature of the room (floor and walls) and the radiant temperature of the human body is minimal.
- The room temperature is high before operation.
- During the heating process, when the number of occupants decreases.

Key features of indoor units

NEW

FEETWARM (FOR HEATING OPERATION)



PC-ARFG



RCI-FSRP + P-AP160NAE2

Head to toe comfort during winter

Intelligent heated air distribution, tailored for the human body.

FeetWarm is complex yet effortless comfort function integrating various parameters together. Available in our Twin-Sense cassette, it prevents the natural effect of cold air sinking and hot air rising, to create enveloping warmth for all occupants.

FeetWarm's boasts 4 intelligent features:

- Thanks to the Twin-Sense radiant sensor, it can detect heat stratification effects inside the room, which usually cause the floor and lower levels to be cooler.
- A 2-step action to first create consistent warmth, then to maintain it.
- Advanced heat air flow optimization, by sophisticated control of the 4-way cassette's individual louvres.
- The lower levels of the room (floor level, feet level, leg level) reach desired temperatures, for total comfort.

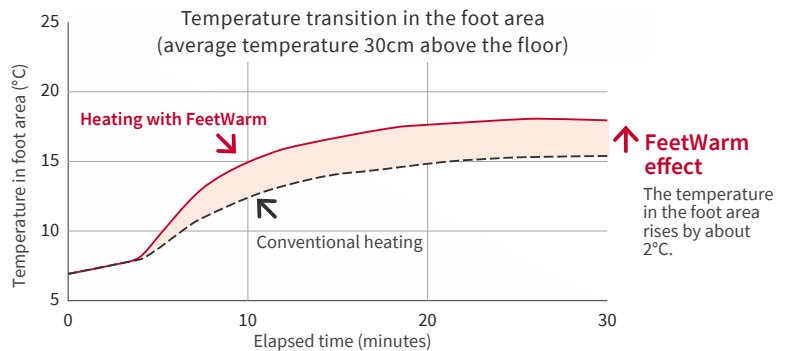

How does it work?

Step 1.

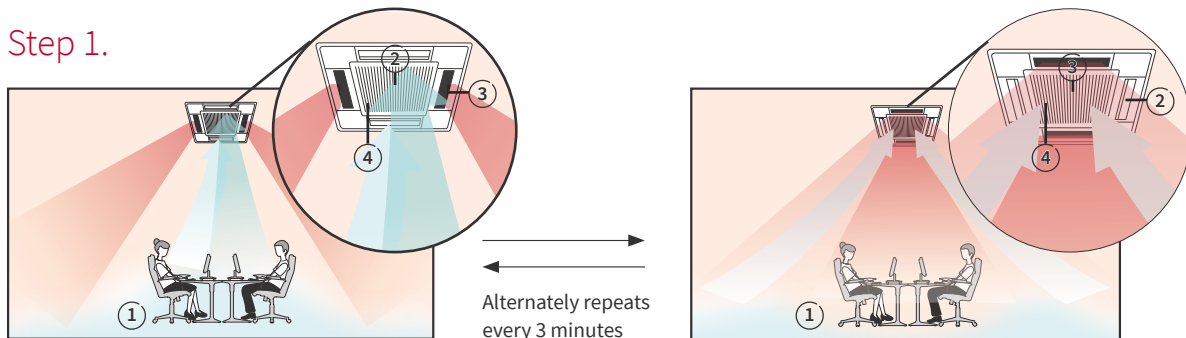

① The radiant sensor detects a temperature drop in the floor and around your feet.

② The cassette partially closes two louvres automatically.

③ The air flow strengthens through the two remaining open louvres, and targets the floor to warm it up quickly¹.

Louvre openings alternate every three minutes from wide open to partially closed to cover a wider floor area.

④ As louvre openings close, suction increases in the central inlet grill for a faster warming effect.

¹ Caution: when the indoor unit changes to heating, the sudden change in air flow might cause occupants to feel a cold draft sensation.

Effect of FeetWarm- Step 1.

Temperature distribution around the area of the feet (30min after air conditioning heating operation starts).

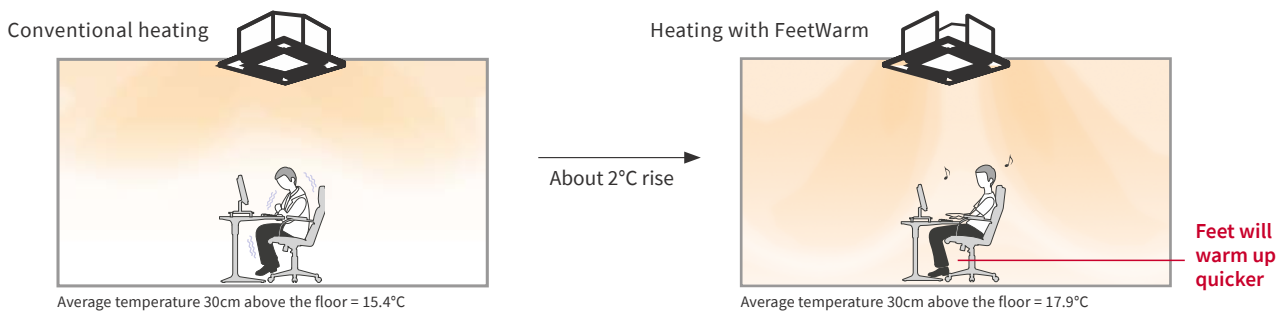

[Image based on calculation results]



Step 2.

- ① When the radiant temperature sensor detects that the lower level is no longer cold, FeetWarm shifts to its second step for a more even temperature throughout the room.
- ② One louvre remains closed.
- ③ Three remaining open louvres follow Auto-Swing air flow direction, continuously moving up/down. This leads to faster circulation of the warm air in all areas of the room.
- ④ Suction of colder air remains facilitated thanks to the one partially closed louvre.

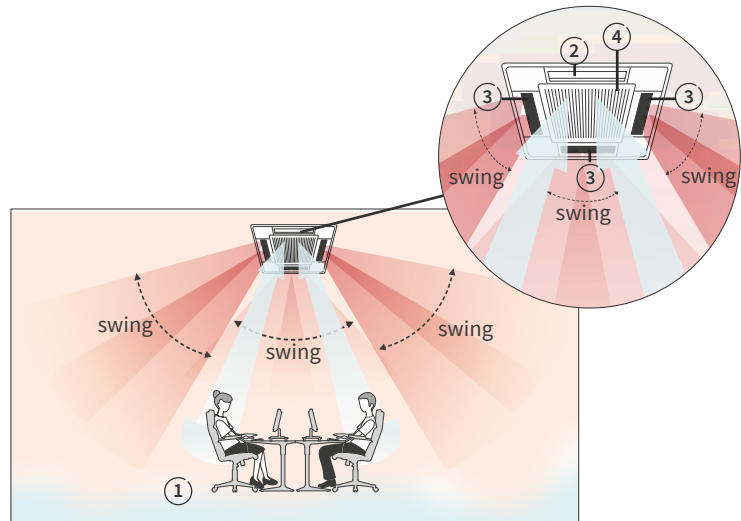

Effect of FeetWarm- Step 2.

FeetWarm: Step 1 (end)

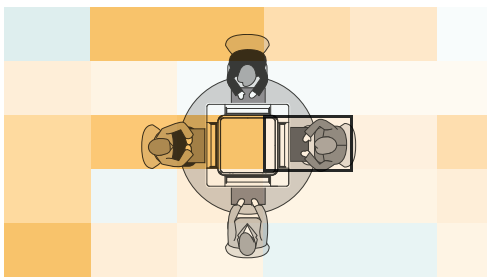

FeetWarm Step 2 (after 20min)

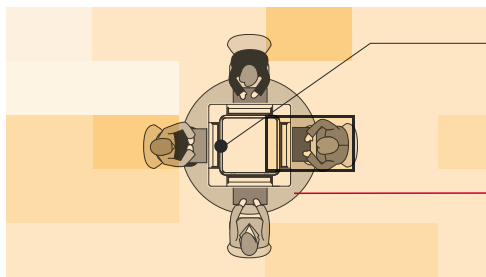

Twin-Sense cassette

Warm and even temperature!

[Measurement condition Based on Hitachi research].
 See simulation result under the following conditions above. Unit capacity: 8.0kW, room size: "height 3.2m, length 6.3m, width 6.3m", indoor initial temperature: 7°C, outdoor temperature: 7°C, indoor airflow temperature: 30°C for 0-5 minutes, Gradually rise from 30°C to 40°C after 5 minutes, Multi-function remote control setting: Airflow heat control "effective / long".
 (Note) The effect varies depending on the size of the room and the load.

Key Indoor Features

FloorSense Cool (for cooling operation)



RCI-FSRP
+
P-AP160NAE2



PC-ARFG

Prevents floor overcooling.

When the room has undergone prolonged cooling, the floor may overcool, due to cold air sinking below layers of warmer air.

The radiant sensor can detect when the floor becomes too cold. The air conditioning will automatically blow softer to prevent overcooling.*¹

*¹ When a group of people return to the room or the room temperature rises due to sunlight, the cooling operation returns to normal.

CONTEXT



After prolonged cooling operation, the room might get cold.

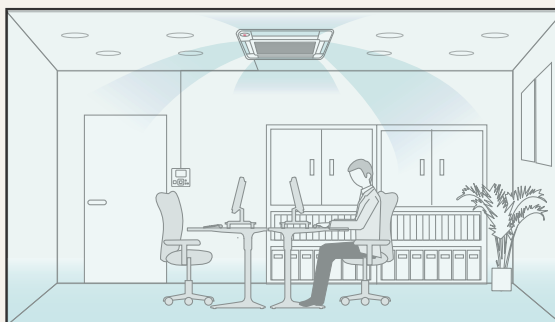

STEP 1



Detection of overcooling.

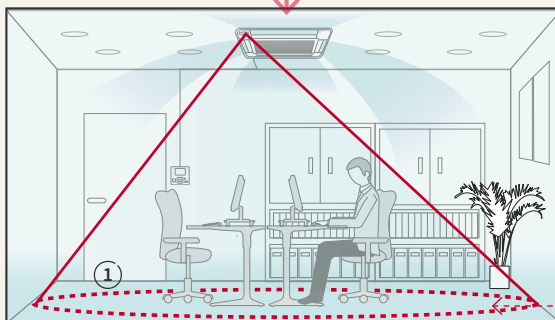

① Detection of cold accumulation at floor level by radiant sensor.

STEP 2



Reduction of overcooling.

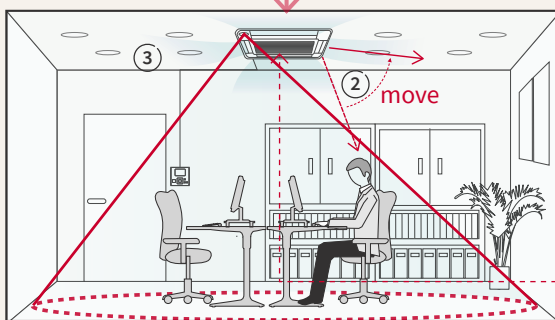

② Louvre direction is adjusted to horizontal blow to reduce direct air contact with the floor.

③ Adjustment of air conditioning capacity (reduction).

Key Indoor Features

Choice of direct or indirect airflow



RCI-FSRP
+
P-AP160NAE2



PC-ARFG



PC-ARF1

Do you prefer to feel the air? Or do you prefer more subtle air airflow?

Choose your preferred air sensation and let the air conditioner adjust the louvre direction to your liking.

Our 4-zone motion sensor divides the room into 4 areas and can detect presence of occupants within each room.

- Direct air flow: Twin-Sense cassette will target the corners with human activity.
- Indirect air flow: Twin-Sense cassette will avoid the corners where occupants are detected.

Indirect air flow: gentle, subtle air that goes unnoticed.

Horizontal air flow, for circulation above and around occupants without air blowing directly on them.

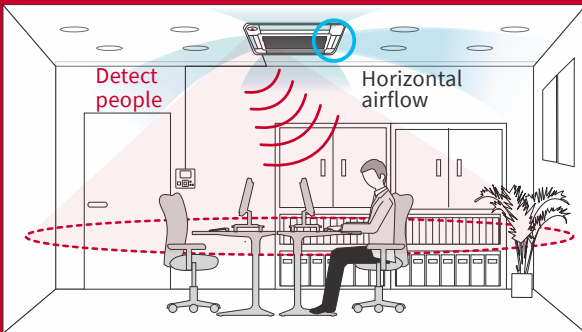

Ideal in places where occupants remain immobile for a long time: restaurants, offices and theatres.

Direct air flow: air flowing sensation to the body.

Auto swing of louvres, to ensure that every occupant can feel the air blowing.

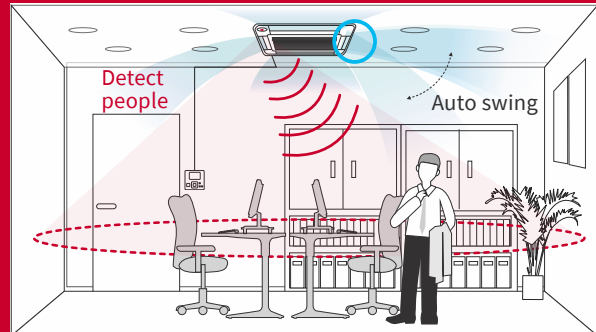

Ideal in places where occupants need quick warm up or cool down: entrance areas and corridors and hotel lobbies.

Notes: When room vacancy is detected, the air is directed in the way the controller (PC-ARFG) is set up. (Note) 4-zone motion sensor may not be effective in the following cases:
 · If the room is occupied but the movement is minimal, the system might consider the room as vacant.
 · If an object with a temperature different to the surrounding is in motion, it might be considered as human presence.

Key Indoor Features

Hotel Setback

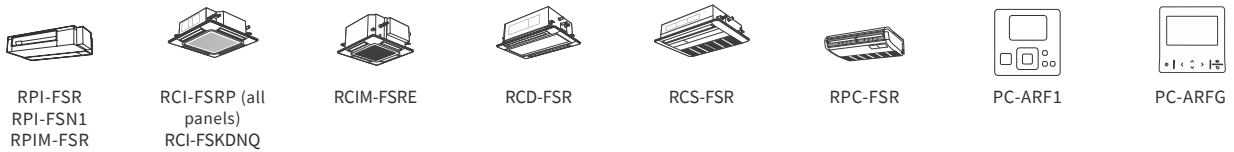

Interlock the air conditioner with a hotel keycard and set an eco temperature for the time of room vacancy.

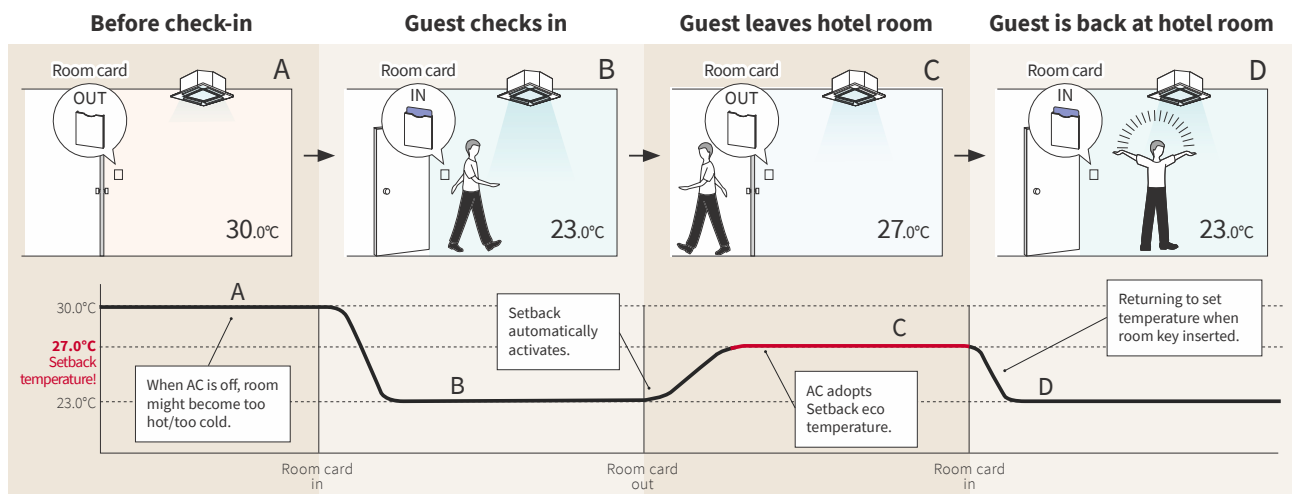

Auto-Save (WITH MOTION SENSOR)

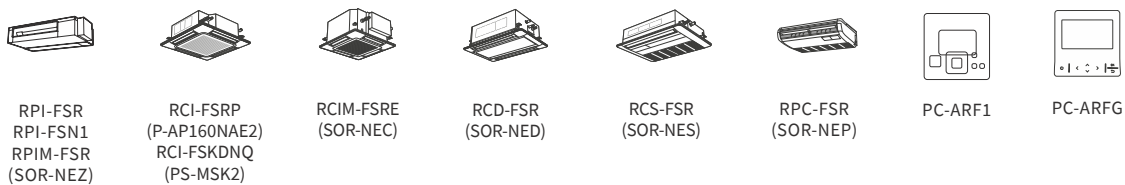

Save more energy while improving comfort!

When adding a motion sensor to the indoor unit, auto-save function will adjust the air conditioning power to the human activity level.

How does Auto-Save work?

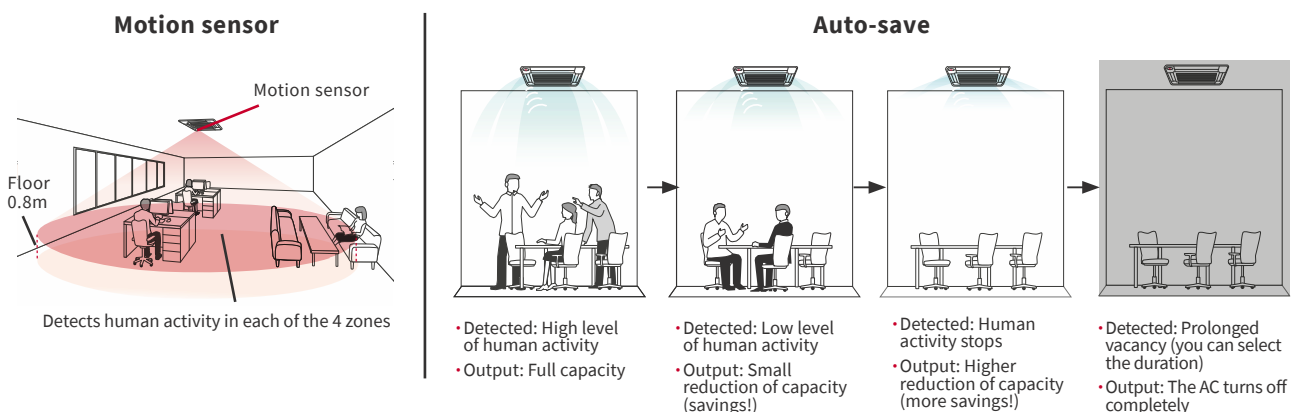

Key Indoor Features

FrostWash ❄️



RPI-FSR
RPIM-FSR



RCI-FSRP
(All panels)



RCIM-FSRE



RCD-FSR



RCS-FSR



RPC-FSR



PC-ARFG

Now available in 6 types of VRF indoor units, our exclusive coil self-cleaning technology uses frost to wash away the dirt.

How does FrostWash work?

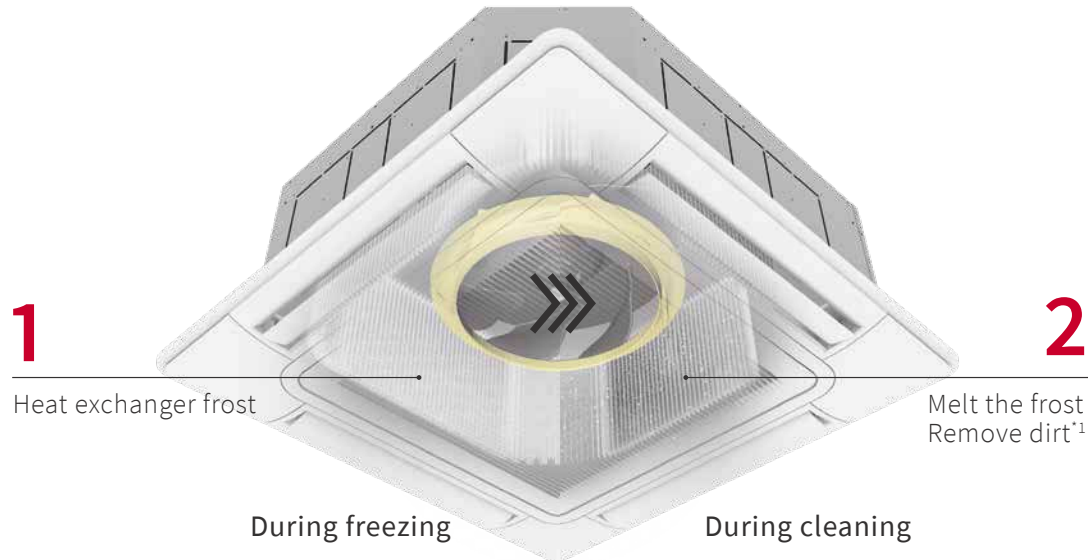

- FrostWash freezes the heat exchanger, capturing the dirt.
- When the frost melts, the dirt detaches from the fins.
- As a result, the air volume can be maintained over time, which contributes to a sustainable performance of the indoor unit and comfort.

The FrostWash self-cleaning process can be activated manually or automatically at scheduled intervals.

Note: FrostWash is only available when the indoor unit is under a single-cabinet SideSmart system (8HP to 18HP).

* 1 Dirt removal depends on the usage environment.

Indoor Unit Solutions

Ducted units

THE MOST DISCREET AIR CONDITIONING EXPERIENCE

Our 8 types of ducted units offer a variety of ESP levels, to facilitate integration into your next commercial project.

NEW



HIGH ESP (DC)

[RPI-FSR, RPI-FSN1]

- High ESP: Up to 200Pa (RPI-2.0FSR) or 230Pa (RPI-8.0/10.0FSN1).
- Flexible choice of air suction connection, rear or bottom.
- GentleCool available, to prevent cold draft when cooling starts.
- Hotel Setback available.



COMPACT (DC)

[RPIZ-HNDTSQ]

- 192mm height! Ideal for installations above closets or windows.
- Drain-pump with 900mm lift as standard optional part.
- Quiet noise level down to 20dB(A).
- Fan speed: 6 taps available.

NEW



MEDIUM ESP (DC)

[RPIM-FSR]

- 3 levels of ESP available: 50/100/150Pa.
- Flexible choice of air suction connection, rear or bottom.
- GentleCool available, to prevent cold draft when cooling starts.
- Hotel Setback available.

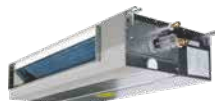

COMPACT (AC)

[RPIZ-HNATNQ]

- 192mm height! Ideal for installations above closets or windows.
- Drain-pump with 900mm lift as standard optional part.
- Quiet noise level down to 20dB(A).



HIGH ESP (AC)

[RPIH-HNAUNQ, RPI-FSNQ]

- High ESP (90/120/180Pa).
- Slim & space saving design thanks to a height of 300mm only (RPIH-HNAUNQ).



LARGER AIR VOLUME (AC)

[RPI-FSN2SQ]







- Two external static pressure settings for more flexibility.
- High external static pressure: Up to 120Pa (140Pa in 7HP).
- Ideal for air ducting to multiple zones.

Nominal cooling capacity range

Ducted indoor units		Cooling (kW)	2.2	2.8	3.6	4.0	4.3	5.0	5.6	6.3	7.1	8.0	8.4	9.0	11.2	14.0	14.2	16.0	18.0	22.4	28.0
NEW	HIGH ESP (DC) [RPI-FSR, RPI-FSN1]								●		●	●			●	●		●		●	●
NEW	MEDIUM ESP (DC) [RPIM-FSR]		●	●		●			●		●	●			●	●		●			
	HIGH ESP (AC) [RPIH-HNAUNQ, RPI-FSNQ]												●	●	●		●	●		●	●
	COMPACT (DC) [RPIZ-HNDTSQ]		●	●	●	●		●	●	●	●										
	COMPACT (AC) [RPIZ-HNATNQ]		●	●	●	●		●	●	●	●										
	LARGER AIR VOLUME (AC) [RPI-FSN2SQ]											●			●	●		●	●		

Full Outside Air Ducted indoor units		Cooling (kW)	14	22.4	26	33.5	45	56
	100% OUTSIDE AIR [RPI-KFNQ, RPI-KFNQL, RPI-KFNQH, RPI-KFNQLF, RPI-KFNQHF]		●	●	●	●	●	●

FEATURES COMPARISON

Model	NEW HIGH/ MEDIUM ESP (DC)		NEW HIGH ESP (8/10HP) (DC)		HIGH ESP (AC)	HIGH/MEDIUM ESP (8/10HP) (AC)	COMPACT (DC)	COMPACT (AC)	LARGER AIR VOLUME (AC)
									
	RPI-FSR RPIM-FSR	RPI-FSN1	RPIH-HNAUNQ	RPI-FSNQ	RPIZ-HNDTSQ	RPIZ-HNATNQ	RPI-FSN2SQ		
Temperature Setting Rate	0.5°C/1.0°C	0.5°C/1.0°C	1.0°C	1.0°C	1.0°C	1.0°C	1.0°C		
Fan Speed	4 taps	4 taps	3 taps	1 tap	6 taps	3 taps	3 taps		
Louvre Direction	-	-	-	-	-	-	-		
Individual Louvre Setting	-	-	-	-	-	-	-		
Auto Louvre Setting	-	-	-	-	-	-	-		
Dry mode Availability	●	●	●	●	●	●	●		
Setback (Away Function)	●	●	-	-	-	-	-		
Cold Draft Prevention (*1)(*4)	●	●	●	●	●	●	●		
Comfort setting	Control Cool Air (GentleCool) (*2)	●	●	-	-	-	-		
Direct/Indirect louvre direction in COOL	-	-	-	-	-	-	-		
Direct/Indirect louvre direction in HEAT	-	-	-	-	-	-	-		
FeetWarm air flow control	-	-	-	-	-	-	-		
FloorSense Cool air flow control	-	-	-	-	-	-	-		
Power Saving with Motion Sensor (*2)	●	●	-	-	-	-	-		
Outdoor Unit capacity control (*2)	Peak cut control	●	●	-	-	-	-		
	Moderate control	●	●	-	-	-	-		
Indoor Unit Rotation Control (*2)	Indoor Unit Address	●	●	-	-	-	-		
	Indoor Air Temperature difference	●	●	-	-	-	-		
Automatic Fan Operation	●	●	●	●	●	●	●		
AutoBoost (quick function) (*2)	●	●	-	-	-	-	-		
Daylight Saving Time	●	●	●	●	●	●	●		
Power Consumption visualization (*2)	●	●	-	-	-	-	-		
Weekly Schedule Setting	●	●	●	●	●	●	●		
Power-Saving Setting (*2)	●	●	-	-	-	-	-		
NEW FrostWash™ auto-cleaning	●	-	-	-	-	-	-		
Filter cleaning reminder	●	●	●	●	●	●	●		
Check Menu	Sensor Condition Check	●	●	●	●	●	●		
	Model Display (*2)	●	●	-	-	-	-		
	Indoor/Outdoor PCB Check	●	●	●	●	●	●		
	Alarm History Display	●	●	●	●	●	●	●	
Motion Sensor	SOR-NEZ	SOR-NEZ	-	-	-	-	-		
Receiver Kit for wireless remote controller	PC-ALHZ1	PC-ALHZ1	PC-RLH11 PC-ALHZ1	PC-RLH11 PC-ALHZ1	PC-RLH11 PC-ALHZ1	PC-RLH11 PC-ALHZ1	PC-RLH11 PC-ALHZ1		
Drain-up mechanism availability	● (*3)	● (*3)	DUPI-361Q	DUPI-15H2Q	● (*3)	● (*3)	-		
Air filter	F-56/90/160LI B-56/90/160LI	F-280LI B-280LI	KW-PP9/10Q	-	KW-PP5Q KW-PP6Q	KW-PP5Q KW-PP6Q	-		

(*1) This function is utilised to prevent cold discharged air at start-up of heating operation, after defrosting operation, etc.
(*2) Advanced wired remote controller PC-ARF1 needs to be connected.

(*3) Included as standard equipment.
(*4) Please consult your distributor.

Indoor Unit Solutions

Ceiling cassettes

PREMIUM DESIGN & INNOVATIVE FEATURES

Meet with our newly upgraded offer, for upgraded comfort!



4-WAY CASSETTE (DC) [RCI-FSRP]

- (with P-AP160NAE2)
 - Smarter performance thanks to Twin-Sense system.
 - Hitachi exclusive FrostWash auto-cleaning technology.
- (with P-GP160NAP)
 - Award-winning Silent-Ionic™ to fit your indoor aesthetics.
- (with P-GP160NAPU)
 - Facilitated maintenance with auto-elevating grille.

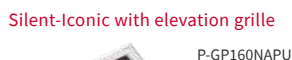

4-WAY CASSETTE (DC) [RCI-FSKDNQ]

- Extensive air distribution possibilities, with 7 louvre positions controllable individually and optional ducting for further reach.
- Motion sensor available for more energy savings.
- Ideal for high ceilings, up to 5.5m long cooling air flow.
- GentleCool available, to prevent cold draft when cooling starts.



4-WAY COMPACT CASSETTE (DC) [RCIM-FSRE, RCI-FSKDNQ]

- 600x600mm dimensions ideal for modular paneled ceilings.
- Whisper quiet operation from 24.5dB(A).
- Multiple fan speeds, ideal for large air volumes and high ceilings (4.6m long cooling air flow).
- Motion sensor available for more energy savings.
- Hitachi exclusive FrostWash auto-cleaning technology.



2-WAY CASSETTE (DC) [RCD-FSR]

- Ideal for long and narrow spaces.
- Whisper quiet operation down to 27dB(A).
- Suitable for high ceilings & cooling air flow up to 4.6m long.
- Hitachi exclusive FrostWash auto-cleaning technology.
- GentleCool available, to prevent cold draft when cooling starts.







1-WAY CASSETTE (DC) [RCS-FSR]

- Ideal for small corners or installation by the window side.
- Can accommodate downward air flow or side air flow direction.
- Whisper quiet operation down to 27dB(A).
- GentleCool available, to prevent cold draft when cooling starts.

Nominal cooling capacity range from 1.6kW to 16kW

Ceiling cassettes	Cooling (kW)	1.6	2.2	2.8	4.0	5.6	7.1	8.0	11.2	14.0	16.0
NEW 4-WAY CASSETTE (DC) [RCI-FSRP]				●	●	●	●	●	●	●	●
4-WAY CASSETTE (DC) [RCI-FSKDNQ]				●	●	●	●	●	●	●	●
NEW 4-WAY COMPACT CASSETTE (DC) [RCIM-FSRE]		●	●	●	●	●	●				
NEW 2-WAY CASSETTE (DC) [RCD-FSR]			●	●	●	●	●	●	●	●	●
NEW 1-WAY CASSETTE (DC) [RCS-FSR]			●	●	●	●	●	●			

FEATURES COMPARISON

Model	4-WAY CASSETTE TYPE (DC MOTOR TYPE)		4-WAY CASSETTE COMPACT TYPE (DC MOTOR TYPE)	2-WAY CASSETTE TYPE (DC MOTOR TYPE)	1-WAY CASSETTE TYPE (DC MOTOR TYPE)
	NEW  RCI-FSRP	 RCI-FSKDNQ	NEW  RCIM-FSRE	NEW  RCD-FSR	NEW  RCS-FSR
Temperature Setting Rate	0.5°C/1.0°C	0.5°C/1.0°C	0.5°C/1.0°C	0.5°C/1.0°C	0.5°C/1.0°C
Fan Speed	4 taps	4 taps	4 taps	4 taps	4 taps
Louvre Direction	7 (*4)	7 (*4)	7 (*4)	7 (*4)	7 (*5)
Individual Louvre Setting	●	●	●	●	-
Auto Louvre Setting	●	●	●	●	●
Dry mode Availability	●	●	●	●	●
Setback (Away Function)	●	●	●	●	●
Cold Draft Prevention Availability (*1)	●	●	●	●	●
Comfort setting Control Cool Air (GentleCool) (*2)	●	●	●	●	●
NEW Direct/Indirect louvre direction in COOL	●	-	-	-	-
NEW Direct/Indirect louvre direction in HEAT	●	-	-	-	-
NEW FeetWarm air flow control	●	-	-	-	-
NEW FloorSense Cool air flow control	●	-	-	-	-
Power Saving with Motion Sensor (*2)	●	●	●	●	●
Outdoor Unit capacity control (*2)	Peak cut control	●	●	●	●
	Moderate control	●	●	●	●
Indoor Unit Rotation Control (*2)	Indoor Unit Address	●	●	●	●
	Indoor Air Temperature difference	●	●	●	●
Automatic Fan Operation	●	●	●	●	●
AutoBoost (quick function) (*2)	●	●	●	●	●
Daylight Saving Time	●	●	●	●	●
Power Consumption visualization (*2)	●	●	●	●	●
Weekly Schedule Setting	●	●	●	●	●
Power-Saving Setting (*2)	●	●	●	●	●
NEW FrostWash™ auto-cleaning	●	-	●	●	●
Filter cleaning reminder	●	●	●	●	●
Check Menu	Sensor Condition Check	●	●	●	●
	Model Display (*2)	●	-	-	●
	Indoor/Outdoor PCB Check	●	●	●	●
	Alarm History Display	●	●	●	●
Motion Sensor	P-AP160NAE2	PS-MSK2	SOR-NEC	SOR-NED	SOR-NES
Receiver Kit for wireless remote controller	PC-ALH3	HR4A10NEWQ PC-ALH3	PC-ALHC1	PC-ALHD1	PC-ALHS1
Drain-up mechanism availability	● (*3)	● (*3)	● (*3)	● (*3)	● (*3)
Fresh air intake accessory	● (*6)	-	● (*6)	● (*6)	● (*6)
Air filter	F-160L-K F-71L-D1 F-160L-D1 B-160H3	-	-	F-90MD-K1 F-160MD-K1 B-90HD B-160HD	-

(*1) You can use this function to prevent cold discharged air at startup of the heating cycle

(*2) Advanced wired remote controller PC-ARF1 needs to be connected.

(*3) Included as standard equipment.

(*4) 7 angles are available for individual louvre setting, 5 angles only for the operation of Cooling or Dry.

(*5) 5 steps only for the operation of Cooling or Dry.

(*6) A Duct Adapter (Optional part) is available.

Indoor Unit Solutions

Ceiling cassettes

NEW
SILENT-ICONIC™ 4-WAY CASSETTE DESIGN PANEL



Exclusive design developed with architectural designers in mind, the Silent-Iconic panel will compliment any interior.



reddot winner 2021
best of the best

Red Dot Award 2021
(Best of the Best for ground-breaking design quality)



GOOD
DESIGN
AWARD
2020

Good Design Award
(Category: Equipment and facilities for professional use)



iF Design Award 2020
Discipline: Product



Silent-Iconic is designed to harmonise with the space by creating the central part to be a blind shaped air-inlet port and reducing its occupied presence by darkening the air-outlet port.

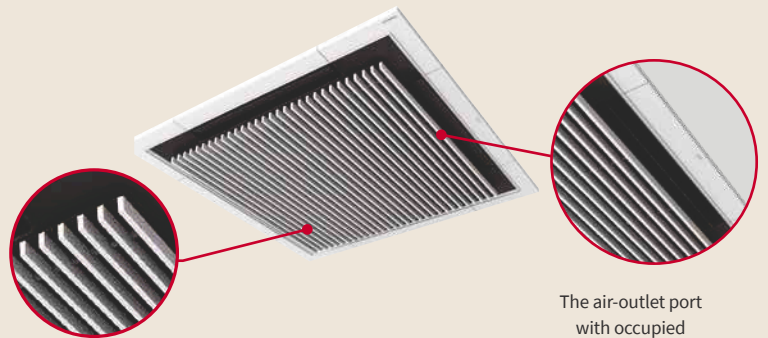

Blind shaped air-inlet port

The air-outlet port with occupied presence suppression

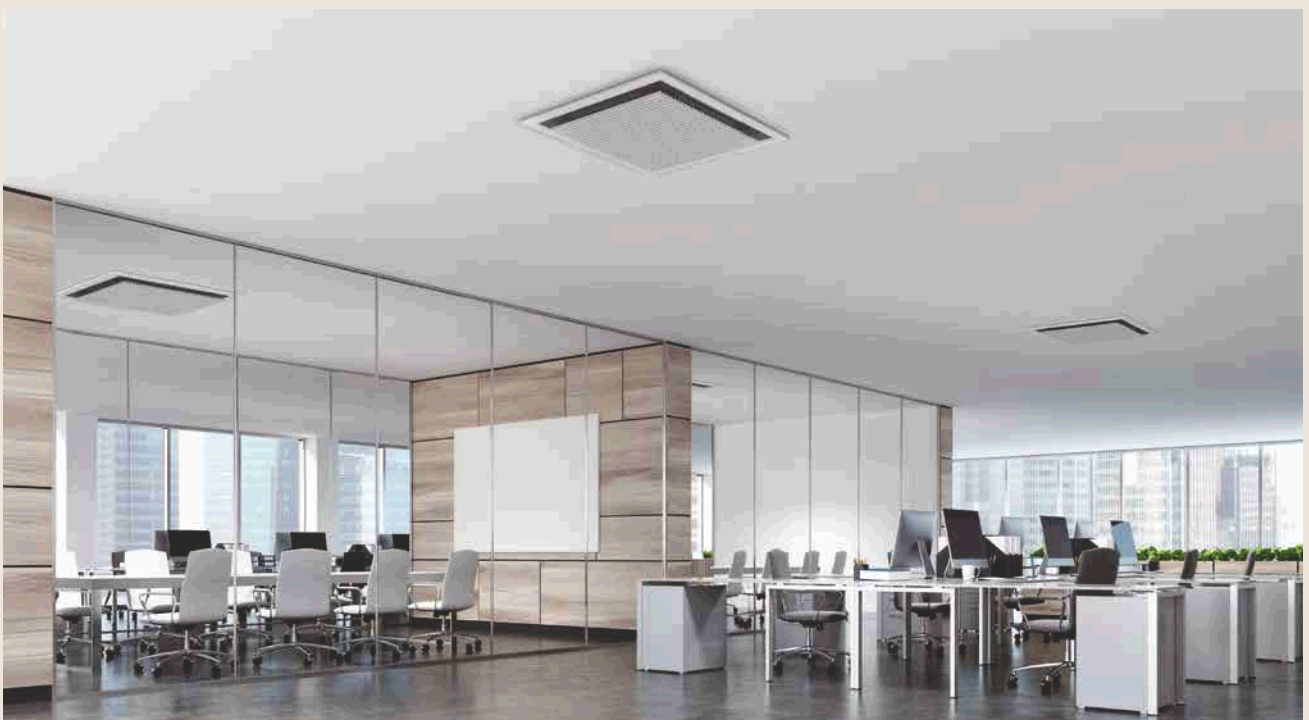



Try our Silent-Iconic virtual installation

Using Augmented Reality, our virtual try-on allows you to visualise how the 4-way cassette or Silent-Iconic looks installed in your space.

4-way Cassette Air Conditioner



Silent-Iconic™ White

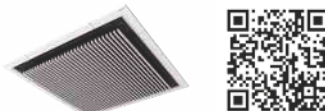

Silent-Iconic™ Black

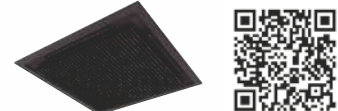

Instructions for use

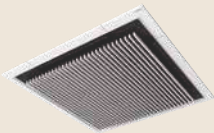

1. Scan the QR code^{*7} and open the web page.



2. Tap the icon.

Tap the icon displayed at the bottom right of the 3D Viewer. If the icon is not displayed, please unhide it in Safari or check the OS version.

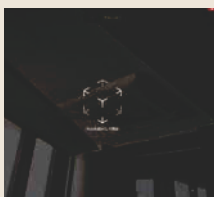

3. AR mode is activated.

Hold out the camera toward the ceiling and get it to detect the environment by moving it in a circular motion.

You may not be able to scan a single-coloured ceiling, so try to scan an area where objects such as downlights or ceiling ventilation fans are installed.



4. Adjustment of placement location.

Shift then move it with a single finger, and rotate or zoom out/in with two fingers to adjust the size that fits the space.

There is also a capture button, so you can take and share the pictures you have placed.

Operating environment

[Device]	
iPhone ^{*1}	iPhone 12 Pro / iPhone 12 Pro Max / iPhone 12 / iPhone 12mini / iPhone 11 Pro / iPhone 11 Pro Max / iPhone 11 / iPhone XS / iPhone XS Max / iPhone XR / iPhone X / iPhone 8 Plus / iPhone 8 / iPhone 7 Plus / iPhone 7 / iPhone 6s Plus / iPhone 6s / iPhone SE2 / iPhone SE
iPad ^{*2}	iPad Pro (all models) / iPad (6th generation) / iPad (5th generation)
[OS]	iOS ^{*3} 12.1 or later
[Browser]	Safari ^{*4} / Google Chrome ^{*5} / Firefox ^{*6}

*1 iPhone is a trademark of Apple Inc., registered in the United States and other countries.

*2 iPad is a trademark of Apple Inc., registered in the United States and other countries.

*3 iOS is the Operating System name of Apple Inc. iOS is a registered trademark or trademark of Cisco Systems, Inc. or its affiliates in the United States and other countries and is used under license.

*4 Safari is a trademark of Apple Inc., registered in the United States and other countries.

*5 Google Chrome is a trademark or registered trademark of Google Inc.

*6 Firefox is a trademark or registered trademark of the United States Mozilla Foundation in the United States and other countries.

*7 QR code is a registered trademark of Denso Wave Incorporated.

Indoor Unit Solutions

Ceiling cassettes



NEW

4-WAY CASSETTE HIGH EXTERNAL STATIC PRESSURE TYPE
(DC) [RCI-FSRP]

LINE-UP SUMMARY



P-AP160NA3

STANDARD

- FrostWash technology
- GentleCool
- (H×W×D) 40×950×950 mm



P-AP160NAE2

TWIN-SENSE

- Smarter with 4-zone motion sensor & radiant sensor
- (H×W×D) 40×950×950 mm



SILENT-ICONIC™

- Award winning design panel
- (H×W×D) 52×950×950 mm

• 2 colours available

• Auto-elevating grille option



White
P-GP160NAP



Black
P-GP160NAP

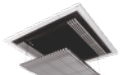

P-GP160NAPU

Twin-Sense cassette

Adaptive comfort for real life applications

EXCLUSIVE GENTLECOOL

(standard feature)

During cooling, the anti cold-draft control function prevents the perception of a cold draft in the discharged air temperature.

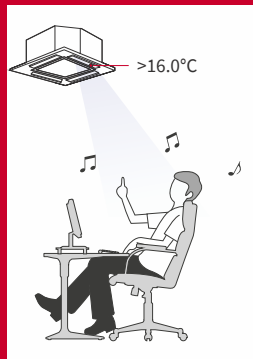

NEW FEETWARM

(with radiant temperature sensor)

During heating, Feetwarm feature ensures warmth reaches and remains on the floor and around occupants' feet and legs.

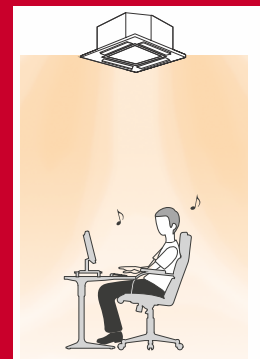

NEW FLOORSENSE COOL

(with radiant temperature sensor)

During cooling, based on indoor unit's new radiant sensor, the multi-louvres adjust to the precise airflow position and cooling capacity to prevent the cold air from sinking and overcooling the floor area.

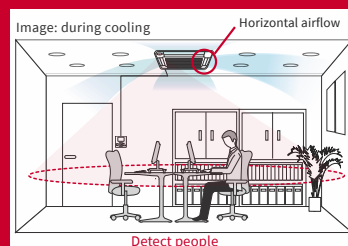

NEW & EXCLUSIVE CROWD-SENSE

(with motion sensor + radiant temperature sensor)

When detecting an increase of occupants in the room, Twin-Sense anticipates the additional heat source of human bodies.

The cassette immediately and pro-actively adjusts operation for a more stable indoor temperature.



NEW

4-WAY COMPACT CASSETTE

(DC) [RCIM-FSRE, RCI-FSKDNQ]



① Ideal for suspended ceilings.

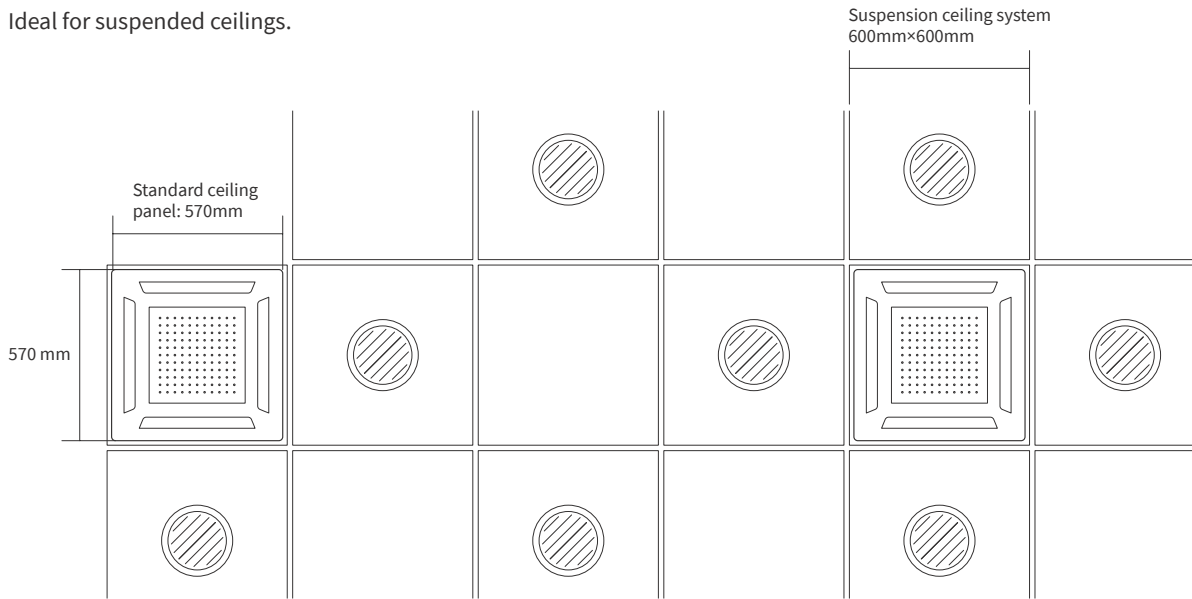

The 600x600 unit can fit in between lighting panels without any disruption.

② Whisper quiet sound level

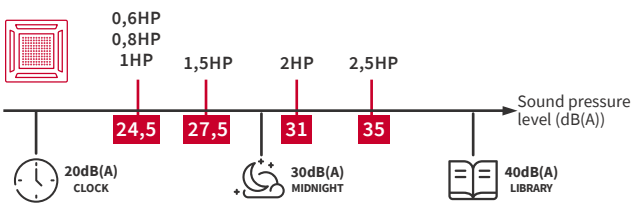

④ Suitable for high ceilings
Standard drain pump: up to 850mm lift.

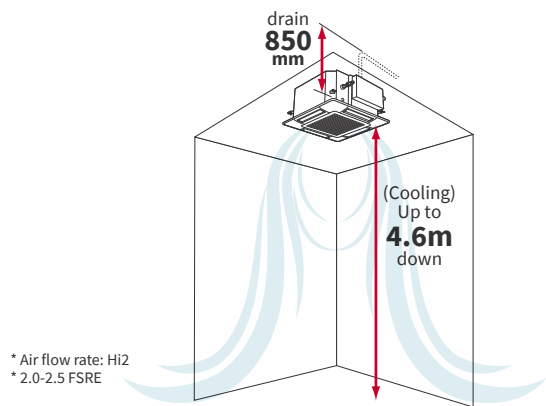

③ Aesthetics

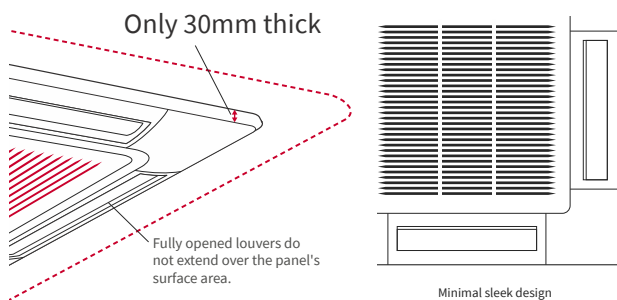

⑤ FrostWash™



Long lasting performance

FrostWash can remove dirt from the coil and discharge it to outside together with condensate water, thus to maintain airflow and capacity.

Indoor Unit Solutions

Wide range of systems for minimal installation works

The new SideSmart VRF range offers our widest choice of indoor units, providing you with the versatility to complement any interior.

NEW



WALL MOUNTED (DC)

[RPK-FSRM, RPK-FSRHM]

- Minimal installation procedure
- Flexible discreet design suitable for any interior
- Available without expansion valve for extra-quiet operation (0.6-1.5HP)
- GentleCool available to prevent perception of a cold draft when cooling starts

NEW



CEILING SUSPENDED (DC)

[RPC-FSR]

- Suitable to high ceilings, with long cooling flow up to 5.6m
- Optional motion sensor for extra savings
- Whisper quiet operation down to 28dB(A)
- GentleCool available, to prevent perception of a cold draft when cooling starts



FLOOR/CEILING CONVERTIBLE (AC)

[RPFC-FSNQ]

- 2-in-1: versatile unit which can be either floor mounted or ceiling suspended
- Minimal installation work
- Suitable for fresh air intake



FLOOR EXPOSED (AC)

[RPF-FSN2E]

- Easy installation
- Space saving slim unit (220mm depth)
- 630mm height only, ideal for under-the-window installation



FLOOR CONCEALED (AC)





[RPFI-FSN2E] / [RPFI-FSNQ]

- Ideal for spaces without ceiling plenum, can be visually hidden in floor cavities and along the walls
- Space saving slim unit (only 202/220mm deep)
- Only 620mm high, ideal for under-the-window installation

Nominal cooling capacity range from 1.7kW to 16kW

Concealed & exposed indoor units		Cooling (kW)	1.7	2.2	2.8	3.6	4.0	4.3	5.0	5.6	6.3	7.1	8.0	8.4	9.0	11.2	14.0	14.2	16.0
WALL MOUNTED (DC) [RPK-FSRM, RPK-FSRHM]	 NEW		●	●	●		●			●		●	●			●			
FLOOR / CEILING CONVERTIBLE (AC) [RPFC-FSNQ]									●	●	●	●		●	●	●		●	
CEILING SUSPENDED (DC) [RPC-FSR]							●			●		●	●			●	●		●
FLOOR EXPOSED (AC) [RPF-FSN2E]	 NEW				●		●			●		●							
FLOOR CONCEALED (AC) [RPFI-FSN2E]					●		●			●		●							
FLOOR CONCEALED (AC) [RPFI-FSNQ]					●			●		●		●							

FEATURES COMPARISON

Model	WALL MOUNTED NEW		FLOOR/CEILING CONVERTIBLE	CEILING SUSPENDED NEW		FLOOR EXPOSED	FLOOR CONCEALED
							
	RPK-FSRM RPK-FSRHM		RPFC-FSNQ	RPC-FSR		RPF-FSN2E	RPFI-FSN2E RPF-FSNQ
Temperature Setting Rate	0.5°C/1.0°C		1.0°C	0.5°C/1.0°C		1.0°C	1.0°C
Fan Speed	4 taps		3 taps	4 taps		3 taps	3 taps
Louvre Direction	7 (*5)		7 (*5)	7 (*5)		-	-
Individual Louvre Setting	-		-	-		-	-
Auto Louvre Setting	-		-	-		-	-
Dry mode Availability	●		●	●		●	●
Setback (Away Function)	●		-	●		-	-
Cold Draft Prevention Availability (*1)(*6)	●		●	●		●	●
Comfort setting	Control Cool Air (GentleCool) (*2)		-	●		-	-
Direct/Indirect louvre direction in COOL	-		-	-		-	-
Direct/Indirect louvre direction in HEAT	-		-	-		-	-
FeetWarm air flow control	-		-	-		-	-
FloorSense Cool air flow control	-		-	-		-	-
Power Saving with Motion Sensor (*2)	-		-	●		-	-
Outdoor Unit capacity control (*2)	Peak cut control		●	-	●		-
	Moderate control		●	-	●		-
Indoor Unit Rotation Control (*2)	Indoor Unit Address		●	-	●		-
	Indoor Air Temperature difference		●	-	●		-
Automatic Fan Operation	●		●	●		●	●
AutoBoost (quick function)	●		-	●		-	-
Daylight Saving Time	●		●	●		●	●
Power Consumption visualization (*2)	●		-	●		-	-
Weekly Schedule Setting	●		●	●		●	●
Power-Saving Setting (*2)	●		-	●		-	-
NEW FrostWash™ auto-cleaning	-		-	●		-	-
Filter cleaning reminder	●		●	●		●	●
Check Menu	Sensor Condition Check		●	●	●		●
	Model Display (*2)		-	-	●		-
	Indoor/Outdoor PCB Check		●	●	●		●
	Alarm History Display		●	●	●		●
Motion Sensor	-		-	SOR-NEP		-	-
Receiver Kit for wireless remote controller	PC-ALHZ1		PC-RLH11 (*7) PC-ALHZ1	PC-ALHP1	PC-ALHZ1	PC-RLH11 (*7) PC-ALHZ1	
Drain-up mechanism availability	-		-	DUPC-63K1 DUPC-71K1 DUPC-160K1		-	-
Air filter	-		-	-		-	-
Strainer kit	MSF-NP63A1 MSF-NP112A1 MSF-NP36AH1		-	-		-	-



COMFORT



POWER-SAVING



MENU



MAINTENANCE



OPTIONAL ACCESSORY

(*1) This function is utilised to prevent cold discharged air at start-up of heating operation, after defrosting operation, etc.
 (*2) Advanced wired remote controller PC-ARF1 needs to be connected.
 (*3) Included as standard equipment.
 (*4) 7 steps are available by individual louvre setting. 5 steps only in the operation of Cooling or Dry.

(*5) 5 steps only in the operation of Cooling or Dry.
 (*6) Please consult your distributor for the availability.
 (*7) Basic Receiver kit (PC-RLH11) is equipped with the unit in package as standard optional part with Wireless Remote Controller (PC-LH7QE).

Ventilation

03



Improve indoor air quality.

Today, the average person spends more than 75% of their day indoors.

Without proper ventilation, CO₂ levels rise, pollutants circulate and potentially harmful bacteria build-up, impacting on the wellbeing, comfort and productivity of occupants.

Make these spaces as healthy and comfortable as possible by incorporating our ventilation solutions into your Hitachi VRF systems.

46 OUR VENTILATION LINE-UP

48 DX-KIT



Our ventilation line-up

Our line-up fulfils the ventilation requirements of the desired space by drawing in clean air from the outside and replenishing indoor spaces.

It features solutions that suit every type of building; you can use the ventilation technology as it is or it can be incorporated into a Hitachi indoor unit via the fresh-air port.

Thanks to our ventilation options, you can optimise the design of your system to meet your needs.

ALL FRESH AIR UNIT



- Creates a comfortable and healthy indoor environment, thanks to the fresh air and heat/cool functions.
- Various controllers can be selected and interfaced with the H-LINK system.
- Longer ducts can be connected on-site, thanks to the higher ESP.

TOTAL HEAT EXCHANGER



- Creates a healthy indoor environment, thanks to the fresh air and ventilation functions.
- Every unit is equipped with a remote controller for the total heat exchanger as a standard part.

From 70 to 1,670 l/s

Fan Air Flow Rate (l/s)	70	140	220	280	300	470	580	830	1,120	1,390	1,670
All Fresh Air Unit				●	●	●	●	●	●	●	●
Total Heat Exchanger	●	●	●	●							

EXTRA AIR-RENEWAL SOLUTION OFFERINGS

We offer two additional options to meet both occupants' needs and your building's requirements.

DX Kit

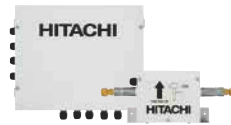

- Offers great flexibility by enabling you to integrate Hitachi VRF into your building's existing air handling units (AHU).
- Wide capacity range (available up to 96HP AHU).
- Wide configuration options with AHU/ Indoor units.

Fresh Air Intake Port



- Optional duct adapter which enables fresh air into the unit so that it can be blown out with conditioned air.
- Connects with the indoor units: 4-way cassette type, 4-way compact cassette type, 2-way cassette type, 1-way cassette type.



DX-Kit

Integrate Hitachi VRF into your pre-existing Air Handling Units (AHU).



Dimensions

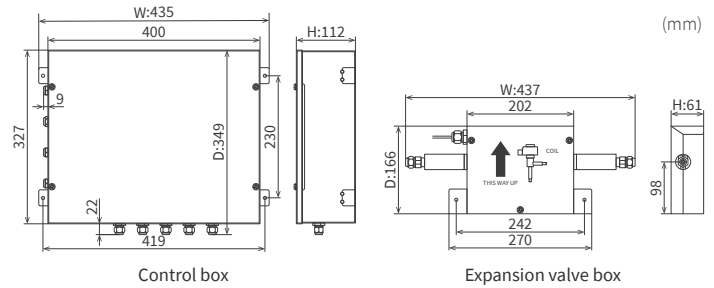

Capacity (HP)		2	4	6	8/10	12~20	22~30	
Model		DXF-2.0A1	DXF-4.0A1	DXF-6.0A1	DXF-10.0A1	DXF-20.0A1	DXF-30.0A1	
Control Box (C Box)	Power Supply	AC1Φ, [220-240V /50Hz] [220V 60Hz]						
	Height	mm	112	112	112	112	112	
	Width	mm	435	435	435	435	435	
	Depth	mm	349	349	349	349	349	
	Weight	kg	5.2	5.2	5.2	5.2	5.2	
	Material		Steel Plate + White Grey Coating					
Expansion Valve Box (EXV Box)	Height	mm	61	61	61	61	61	
	Width	mm	437	437	437	437	437	
	Depth	mm	166	166	166	166	166	
	Weight	kg	1.7	1.7	1.7	1.7	1.7	
	Quantity		1	1	1	1	2	
	Material		Steel Plate + White Grey Coating					
AHU Suction Temperature Range	Cooling	21.0°C to 32.0°C (DB) / 15.0°C to 23.0°C (WB)						
	Heating	15.0°C to 27.0°C (DB)						
Connection Ratio in different configurations → Total AHU or AHU & IDU Connection Ratio against ODU capacity = X (In case of "Inlet Air Temperature Control")		<ul style="list-style-type: none"> • 1 ODU to 1 AHU : 50% < X ≤ 100% • 1 ODU to 1 AHU (Separate Heat Exchanger Type) : 50% < X ≤ 100% • 1 ODU to Multiple AHUs : 50% < X ≤ 100% • 1 ODU to AHU & IDUs : <ul style="list-style-type: none"> (1) 50% < X ≤ 100% → Total AHU capacity: No limitation / Each AHU capacity: No limitation (2) 100% < X ≤ 110% → Total AHU capacity: less than 30% of total capacity / Each AHU capacity: between 2-6HP class 						
Maximum Piping Length	Total	m	<ul style="list-style-type: none"> • 1,000 (When the number of connected [AHU & IDU] in the system is <u>the same or less than</u> the recommended.) • 300 (When the number of connected [AHU & IDU] in the system is <u>more than</u> the recommended.) 					
	Between AHU Heat Exchanger and EXV Box	m	5	5	5	5	5	
Maximum Level Difference	Between ODU and [AHU/IDU]	m	<ul style="list-style-type: none"> • 50 (When ODU is <u>above</u> [AHU & IDU & DX-Kit].) • 40 (When ODU is <u>below</u> [AHU & IDU & DX-Kit].) 					
	Between AHU Heat Exchanger and EXV Box	m	2	2	2	2	2	
Maximum Length	Control wiring between AHU Heat Exchanger and EXV Box	m	10	10	10	10	10	
	Thermistor to AHU Heat Exchanger from C Box	m	10	10	10	10	10	
Temperature Control Modes (*1)		<ul style="list-style-type: none"> • Inlet Air Temperature Control • Outlet Air Temperature Control • Duty Control 						

(*1) [Outlet Air Temperature Control] & [Duty Control] are available only in case of connections "1 ODU to 1 AHU" & "1 ODU to 1 AHU(Separate Heat Exchanger Type)".

DX-KIT: GREAT FLEXIBILITY FOR SIMPLIFIED HVAC UPGRADE

1 Wide range of capacity:

- (DX-Kit) Single capacity from 2HP to 30HP
- (Custom AHU) up to 96HP available by DX-Kit combination

Our DX-Kit can cover from small to large capacity AHU. It can meet any requirement in any application.

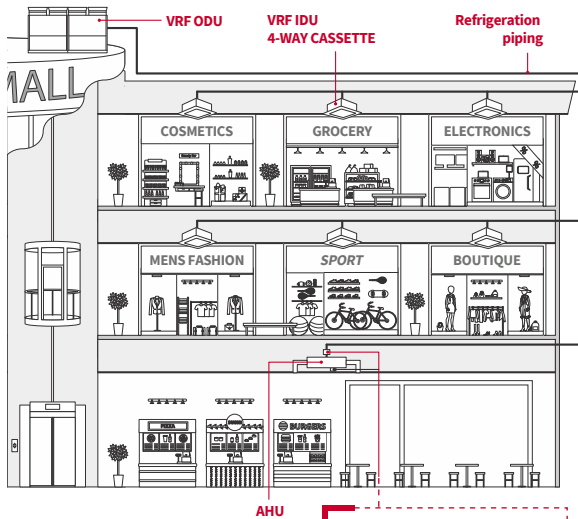

DX-Kit
Above : Expansion Valve Box (EXV Box)
Below : Control Box (C Box)

2 Flexible installation:

- Both outdoor & indoor installation of DX-Kit available
- Design Flexibility in wiring & piping

DX-Kit facilitates system design

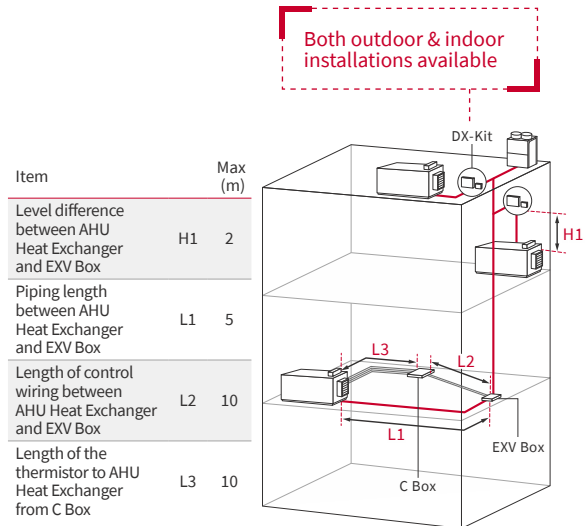

3 4 examples of configuration:

- 1 VRF outdoor unit + 1 AHU
- 1 VRF outdoor unit + 1 AHU (external heat exchanger)
- 1 VRF Outdoor unit + multiple AHUs
- 1 VRF Outdoor unit + VRF indoor units + AHUs

[Example]

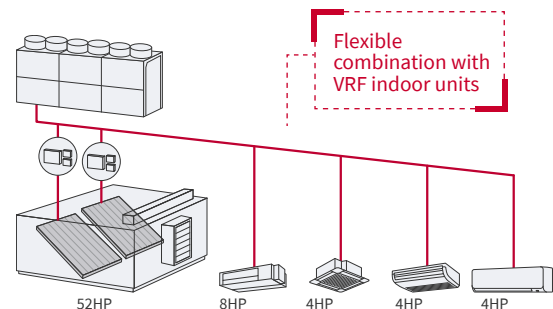
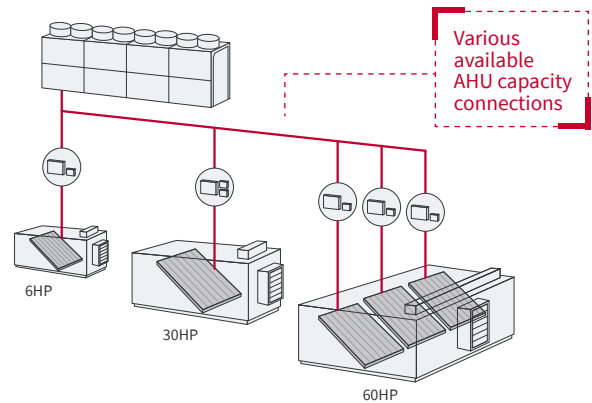
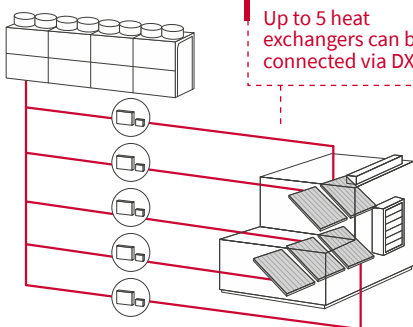

Controllers

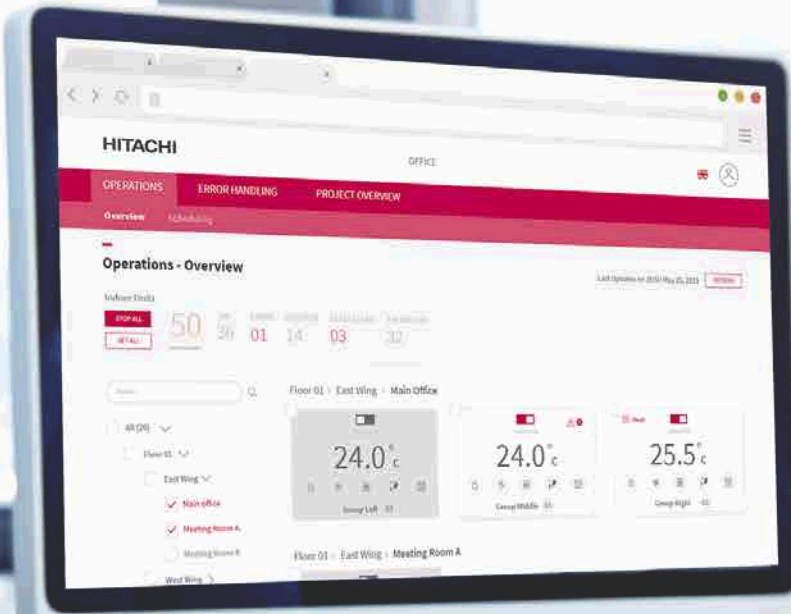

04

New generation: simple and smart!

Everyone deserves comfort, but comfort doesn't mean the same to everyone. That's why control is key. Our controllers offer best-in-class simplicity.

Using our praised Central Stations, building managers can instantly optimise air conditioning in targeted zones. For occupants, our new advanced colour controller provides intuitive navigation with a premium design.

With airCloud Pro, our exclusive new-generation solution, users can manage from one indoor unit to several systems remotely via IoT (web/smartphone).

52 CENTRALISED CONTROLLERS

Line up overview

airCloud Pro

Central Station EX

Central Station EZ

Central Station Mini

59 INDIVIDUAL CONTROLLERS

Line up overview

Advanced Colour wired remote controller

Advanced wired remote controller

Wired remote controller

Simplified wired remote controller

Advanced wireless remote controller

Wireless remote controller

Receiver kit

64 ACCESSORIES

66 H-LINK: ENJOY MORE FREEDOM



Centralised controllers

Control each indoor unit, a specific zone or multiple systems from the one place

airCLOUD PRO* (HC-IoTGW)

- Remote access via smartphone app or web
- Unlimited number of systems, zones and users
- Intuitive scheduling function
- Troubleshooting with access to error history and alerts
- Filter sign display to quickly overview daily maintenance needs
- Ideal for all types of applications

CENTRAL STATION EX (PSC-A128EX1)

- Control capacity: max 2,560 indoor units (+15x Extension Adapter PSC-AD128EX1)
- With energy calculation software (PSC-AS01EXC), determine each tenant's energy usage
- Easy monitoring with simplified interface
- Best option for medium to large scale buildings
- Operate Central Station EX remotely using your laptop or touchscreen PC

CENTRAL STATION EZ (PSC-A64GT)

- Control capacity: max 64 remote control group of indoor units
- Compact and optimised 170x250mm body screens fitting in even small walls
- Easy monitoring with simplified interface
- Best option for medium scale buildings

CENTRAL STATION MINI (PSC-A32MN)

- Control capacity: max 32 remote control group of indoor units
- Compact and optimised 120x140mm body screens fitting in even small walls
- Easy monitoring with simplified interface
- Best option for small scale buildings

SMALL TO LARGE SYSTEMS & FIXED OR CLOUD-BASED



		HC-IoTGW	PSC-A32MN	PSC-A64GT	PSC-A128EX1	
Capacity comparison	Total Connection capacity	RC group	64 (*6)	32	64	2,560 (*1)
		Group	64 (*6)	32	64	2,048 (*1)
		Block	Unlimited (*7)	2/4/8/16	4	512 (*2)
		Area	Unlimited (*7)	-	-	512 (*2)
		Indoor unit	80 (*6)	160	160	2,560 (*1)
		Outdoor unit	16 (*6)	64	64	1,024 (*1)
	Building scale	Small to Large	Small	Medium	Large	
	Operation	Web + Mobile Phone	Touch screen	Touch screen	Touch screen + Web NEW!	
Display	Operation panel size options	Adaptive	3	2	7	
	Layout	-	-	-	●	
	List options	-	-	-	3	
Operation unit	All together	●	●	●	●	
	By layout	-	-	-	●	
	By area	●	-	-	●	
	By block	●	●	●	●	
	By group	●	-	-	●	
	By RC group	-	●	●	-	
	By indoor unit	●	-	-	●	
Control Function	Main 5 functions (*5)	●	●	●	●	
	Individual controller lock	●	●	△ (*3)	●	
	Filter sign reset	●	●	●	●	
	Outdoor unit capacity control	-	△ (*4)	-	●	
	Outdoor unit noise control	-	-	-	●	
Monitor Function	Main 5 functions (*5)	●	●	●	●	
	Individual controller lock	●	●	●	●	
	Alarm status & code	●	●	●	●	
	Filter sign	●	●	●	●	
	Air inlet temperature of indoor unit	-	●	-	●	
	Air inlet temperature of outdoor unit	-	●	-	●	
Schedule Function	Weekly	●	●	●	●	
	Setting times per day	16	10	10	16	
	Special day setting	5	-	-	5	
	Holiday setting	-	-	-	●	
	Annual/Summer/Winter schedule	Future Version	-	-	●	
Other function	Alarm history (records number)	Unlimited	100	100	10,000	
	External in/output history	-	-	-	1,000	
	Management report Visualisation(*11)	Energy Estimation (*8) - Future	●	●	●	
	Data output by external media	Download from Web - Future	-	-	SD card, USB flash drive	
IoT	Connectivity	Ethernet + 4G (*9)	-	-	-	
	Future Extendability	Firmware OTA (*10) Web + Mobile Update	-	-	-	

(*1) One Extension Adapter (PSC-AD128EX1) enable CENTRAL STATION EX to control additional 160 RC groups /128 groups / 160 IDUs / 64 ODUs, and up to 15 adapters can connect to one Central Station EX.

(*2) No restriction on the number of H-LINK.

(*3) Individual Feature Control in Each Remote Controller is not available.

(*4) Applicable only with Schedule function or external signal input. You cannot set it up directly from monitoring panel.

(*5) Main 5 functions meaning: 1) Run/Stop 2) Operation mode 3) Temperature setting 4) Fan speed

5) Louvre control.

(*6) Ability to connect unlimited number of "HC-IoTGW" in one project and control all AC units via one single screen on Web or Mobile Phone.

(*7) Unlimited creation of zones, across multiple "HC-IoTGW" units within the same project.

(*8) Visualisation of outdoor unit energy consumption.

(*9) 4G available through optional 4G module; 4G module package comes with global SIM and pre-paid global data plan.

(*10) OTA: Over-the-air firmware update, provides always up-to-date firmware and latest functionalities.

(*11) Mini, EZ : Accumulated operation time (min) , Accumulated thermo - ON (min) .

EX: Accumulated operation time (min) , Accumulated thermo - ON time (min) , Average air intake temperature of indoor unit , Average air intake temperature of outdoor unit , Average setting temperature , Average RC sensor temperature.

Centralised controllers

airCLOUD PRO*



2021 Good Design Award, Australia
Digital Design - Apps & Software

Specifications

Gateway	HC-IoTGW
Net weight (g)	540
Connection capacity	16 outdoor + 80 indoor units
Power supply (V) (Hz)	100-240, AC 50/60
Max. power consumption (W)	10
Communication port	1 H-LINK, 1 RS485 Port
Internet connection	LAN (Ethernet) or 4G ³
External interface (log storage)	1 micro SD card slot

Functions

IoT connection (cloud-based)	<ul style="list-style-type: none"> • Access via smartphone app or web • Unlimited number of gateways • Unlimited number of locations • Unlimited number of users
Operation unit	<ul style="list-style-type: none"> • Per entire location • Per system • Per zone (unlimited zone creation) • Per indoor unit remote control group
Control function	<ul style="list-style-type: none"> • On/Off • Mode • Set temperature • Fan speed • Louvre • RC lock • Filter sign reset

Monitor Function

- On/Off • Mode • Set temperature
- Air intake temperature • RC sensor temperature (*3)
- Air intake temperature of outdoor unit
- Fan Speed • Louvre • RC prohibition
- Thermo-ON information
- Filter sign/Auto cleaning fault
- Alarm status/Alarm codes

Schedule function

- Weekly schedule • Easy selection of days and zones
- Setting items in schedule is as below; • On/Off
- Operation mode • Setting temperature
- Louvre • Fan speed

* "All Groups Run/Stop" command signal exception function for selected groups is available by "Exception of Run/Stop Operation." function.

System configuration



Recommended applications



OFFICE



HEALTHCARE/
MEDICAL



EDUCATIONAL
FACILITIES



RESTAURANTS/
CAFES



HOTELS &
ACCOMMODATION



RETAIL

Is airCloud Pro for me?

All VRF users can enjoy these benefits:

- Save energy
- Save time and unnecessary transportation
- Delegate VRF systems administration
- Create a comfortable climate for guests

Future-proof

With updates and new features added regularly, airCloud Pro ensures you are always up to date.

- Compatible with new and former Hitachi Variable Refrigerant Flow systems¹

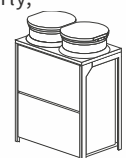

*airCloud Pro available with SideSmart™ from May 2021.

¹ Confirm compatibility of your VRF installation with your Hitachi Cooling & Heating representative.



The control is in your hands
24/7 access via smartphone, tablet, or PC.

For standalone & multi-site VRF applications

✓ Intuitive simplicity

airCloud Pro is designed to make your job easier. An intuitive app that anyone can use, airCloud Pro makes managing your VRF systems easier than ever before.

✓ Control from anywhere

Enjoy the freedom of remote access from your smartphone, tablet or laptop. airCloud Pro allows you to remotely control your VRF system(s) from a single app, saving you travel time.



A simple, yet powerful tool that makes
managing your VRF systems easy.

🌐 Save more energy

Monitor your energy consumption and optimise usage.

- Energy consumption data^{*2}
Simplified graphs to display power consumption
- Intuitive scheduling
Plan operations ahead of time based on your business hours
- Individual controller lock to prevent inappropriate usage from occupants

👍 Simplify your job

- Centralised control of your entire VRF system or selected zones in one touch
- Simplified troubleshooting
A clear error history, concise error description and follow-up
- Smartphone alerts^{*2} in the event of a critical malfunction
- Flexible user management^{*2}
Add users and custom access restrictions

❤️ Create better comfort

Adjust temperature, fan speed, and modes with ease, creating total comfort and the ideal climate throughout your building.

An integrated weather forecast^{*2} display helps you determine the most suitable conditions for your indoor spaces all year round.

🔧 Easy plug-and-play

Our airCloud gateway makes installation a breeze.

Connect to the airCloud via 3G/4G^{*3} or ethernet and pair your VRF systems via QR code.

With automatic detection of indoor units and an optimised installer view, configuring your site and zones has never been quicker.

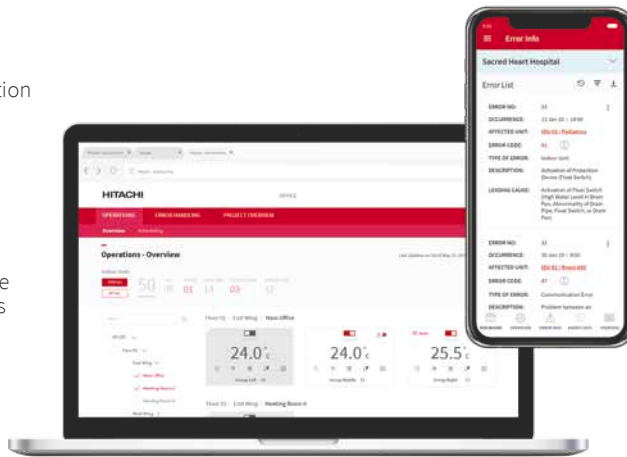

+ data security

Best-in-class standards:
TLS.v1.2, HTTPS 2038 encryption.

Minimal personal details:
Only your name, email address and phone number are required for login.

*2 Functions not available as of September 2019, coming soon.

*3 4G module available as a side accessory.

Centralised controllers

CENTRAL STATION EX FOR LARGE-SCALE BUILDINGS

(PSC-A128EX1)



For medium to large-scale buildings such as hotels, educational facilities, and hospitals, our Central Station EX features a highly intuitive and functional 12.1" wide, wall-mountable, Colour LCD screen.

Control up to 2,560 indoor units with our proprietary H-LINK system with 15 extension adapters (PSC-AD128EX1).

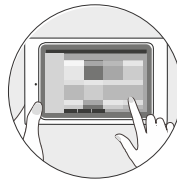

Also, with energy calculation software (PSC-AS01EXC), Central Station EX can help you easily manage each tenant's electricity & report the power consumption of VRF system for each tenant.

Install by add-on software and activate, then, you can select electricity ratio or usage ratio from several methods.

Capacity

H-LINK	16
RC group	2,560 (*1)
Group	2,048 (*1)
Block	512 (*2)
Area	512 (*2)
Indoor unit	2,560 (*1)
Outdoor unit	1,024 (*1)
Building scale	Large

Extension adapter PSC-AD128EX1



Energy calculation software* PSC-AS01EXC



(*1) 1 extension adapter (PSC-AD128EX1) enables Central Station EX to control additional 160 RC groups / 128 groups / 160 IDUs / 64 ODU. Central Station EX can connect up to 15 adapters.

(*2) No restriction on the number of H-LINK

Specifications

Rated power supply	100~240VAC ±10% (50/60Hz)
Electrical power consumption	50W (Max.)
Communication unit	Units of Adopting for H-LINK
Communication line	Two-wire non-polar
Communication speed	9,600bps
Wiring length	1,000m (Total Length)
Display	12.1 inch TFT Colour liquid crystal display
Display control	Touch Panel

Functions

Operation unit	All together Each area Each block Each group Each indoor unit	Each of the following settings is available in 3 different [annual] [summer][winter] categories: → Weekly schedule → Up to 16 actions can be set per day → Exception day setting: 5 different types → Holiday setting	Energy saving: • Run/Stop • RC prohibition • Temperature shift (For Cool/Dry mode: +1.0°C~+9.0°C (+1.0°F~+18.0°F)) (For Heat mode: -1.0°C~-9.0°C (-1.0°F~-18.0°F)) • Mode shift (Mode shifted to Fan when in Cool/Dry mode, and shifted to Stop in Heat mode) • Capacity control on outdoor units • Lower noise control for outdoor units
Control function	On/Off Mode Set temperature Fan speed Louvre RC prohibition Filter sign reset Function selection for indoor units (*1) Function selection for outdoor units (*2) Capacity control for outdoor units (*2) Lower noise control for outdoor units (*2)	Schedule function Setting items in schedule is as below: • On/Off • Operation mode • Setting temperature • Louvre • Fan speed • RC operation prohibition • Capacity control for outdoor units • Lower noise control for outdoor units	External input / output Control/Monitor → Controlled items: • Run/Stop • Mode (Cool/Heat) → Monitored items: • Run/Stop • Mode (Cool/Heat) • Alarm state
Monitor function	On/Off Mode Set temperature Air intake temperature RC sensor temperature (*3) Air intake temperature of outdoor unit Fan Speed Louvre RC prohibition Thermo-ON information Filter sign/Auto cleaning fault Alarm status/Alarm codes	History Alarm history: 10,000 records External In/Output history: 1,000 records Pulse input history: 6 months	Others: • Power consumption signal input • Emergency stop
		Management report Visualisation Up to 2 years worth of data history can be displayed for the following: • Accumulated operation time (min.) • Accumulated thermo-ON time (min.) • Average air intake temp temperature of indoor unit • Average air intake temperature of outdoor unit • Average setting temperature • Average RC sensor temperature	

(*1) Some indoor units may not fully support all functions.

(*2) Available for applicable outdoor units only.

(*3) Whether this is shown on the screen depends on the remote controller settings.

Remote Access to your VRF System

You can now operate Central Station EX from your laptop PC or touch panel PC. Install our software and you can connect from anywhere, using our VPN network.

Example: school

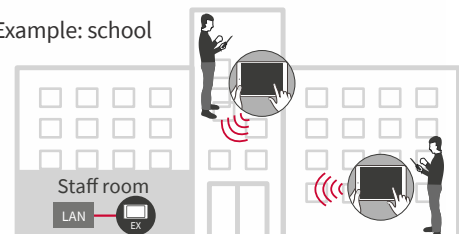

CENTRAL STATION EZ FOR MEDIUM-SCALE BUILDINGS (PSC-A64GT)

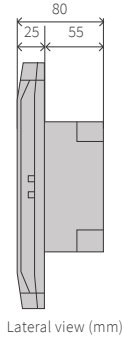
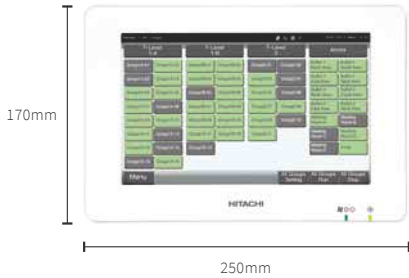

Lateral view (mm)



With easy control via an 8.5" Colour touch panel, its detailed control functionalities such as Weekly Scheduling, Operation hours tracking, and more, help you to save energy.

Up to 64 remote-controlled groups and up to 160 indoor units can be connected to the Central Station EZ.

*The "All Groups Run/Stop" command signal exception function for selected groups is available via the "Exception of Run/Stop Operation" function.

Capacity

RC group	64
Group	64
Block	4
Indoor Unit	160
Outdoor Unit	64
Building Scale	Small-Medium

Specifications

Rated Power Supply	1-, AC 100-240V, 50/60Hz
Electrical Power Consumption	30W (Max.)
Communication Unit	Units of Adopting for H-LINK
Communication Line	Non-polar 2-wire
Communication Speed	9,600bps
Wiring Length	1,000m (Total Length)
Display	8.5-inch Wide Colour LCD (Full Dot)
Display Control	Touch Panel

Functions

Monitor Function	<ul style="list-style-type: none"> Run/Stop/Abnormality Setting Temperature RC Operation Prohibited Setting Accumulated Operating Time Operation Mode Setting Fan Speed Setting Louvre Filter Sign Alarm Code
Control Function	<ul style="list-style-type: none"> Run/Stop* Fan Speed Operation Mode Louvre Temperature Setting RC Operation Prohibited Filter Sign Reset

CENTRAL STATION MINI FOR SMALL-SCALE BUILDINGS (PSC-A32MN)

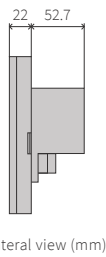
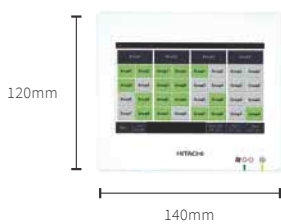

Lateral view (mm)

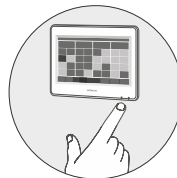

With easy control via an 5.0" Colour touch panel, its detailed control functionalities such as weekly scheduling, operation hours tracking, help you save energy.

Up to 32 remote-controlled groups and up to 160 indoor units can be connected to the Central Station mini.

Capacity

RC group	32
Group	32
Block	4 Patterns (2/4/8/16)
Indoor Unit	160
Outdoor Unit	64
Building Scale	Small

Specifications

Rated Power Supply	1-, AC 100-240V, 50/60Hz
Electrical Power Consumption	20W (Max.)
Communication Unit	Units of Adopting for H-LINK
Communication Line	Non-polar 2-wire
Communication Speed	9,600bps
Wiring Length	1,000m (Total Length)
Display	5.0-inch Wide Colour LCD (Full Dot)
Display Control	Touch Panel

Functions

Monitor Function	<ul style="list-style-type: none"> Run/Stop/Abnormality Setting Temperature RC Operation Prohibited Setting Accumulated Operating Time Operation Mode Setting Fan Speed Setting Louvre Filter Sign Alarm Code"
Control Function	<ul style="list-style-type: none"> Run/Stop* Fan Speed Operation Mode Louvre Setting Temperature Setting RC Operation Prohibited Filter Reset Signal

* "All Groups Run/Stop" command signal exception function for selected groups is available by "Exception of Run/Stop Operation." function.

Individual controllers

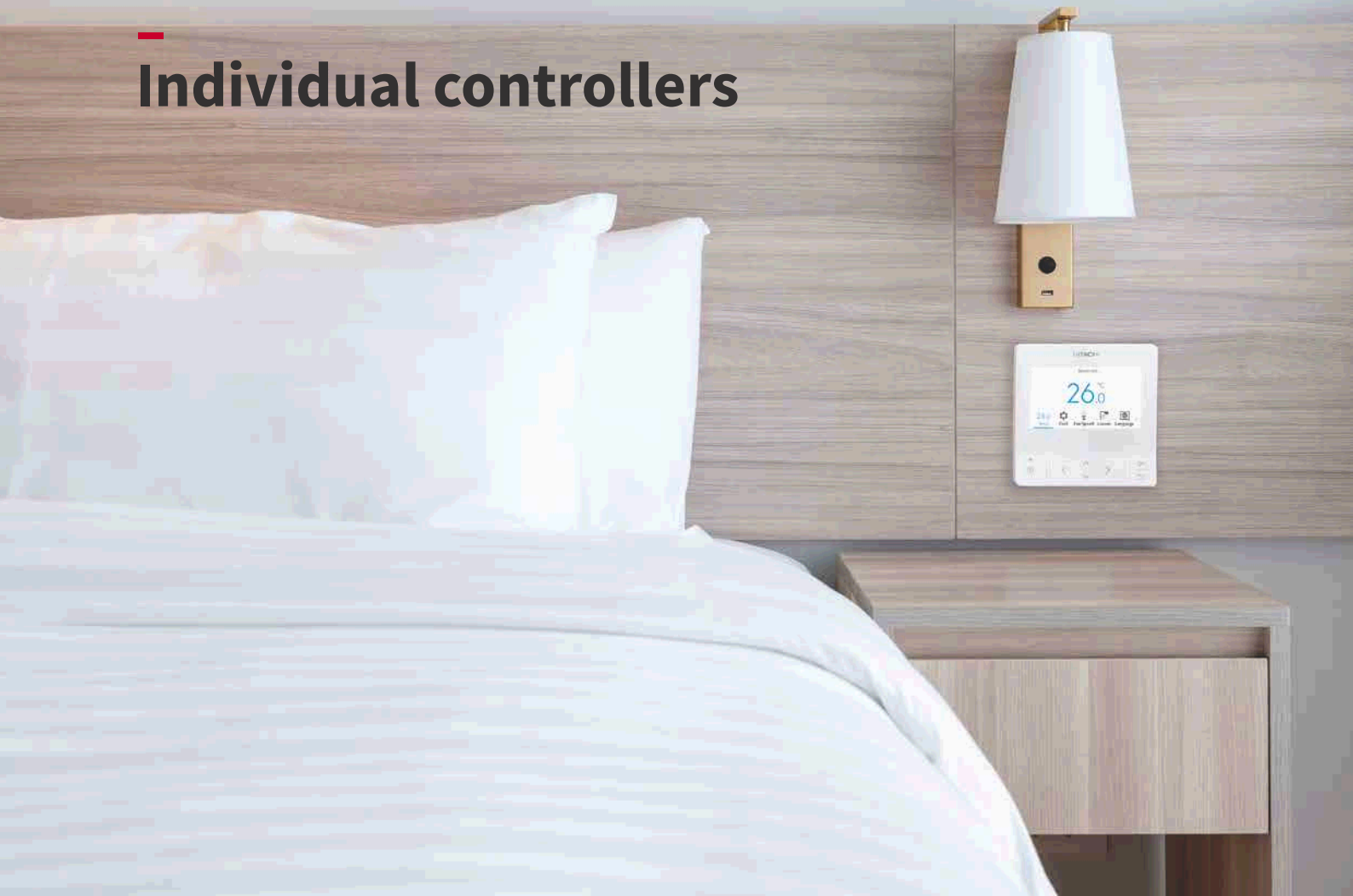

ADVANCED COLOUR WIRED REMOTE CONTROLLER (PC-ARFG)

- Exclusive Colour screen & Award-winning design
- Simplified menu and enhanced UI/UX
- Includes latest VRF features such as FrostWash™ and several comfort settings

WIRED REMOTE CONTROLLER (HCWA10NEGQ)

- 88mm square controller with LCD screen
- Smaller body with multiple features
- Best option for spaces frequented by recurring users, e.g. offices

ADVANCED WIRELESS REMOTE CONTROLLER (PC-AWR)

- Wireless remote controller with more features
- Several temperature units and settings available; 0.5°C/1.0°C/1.0°F
- Ideal for controlling the unit from anywhere in the room, e.g. residential spaces

ADVANCED WIRED REMOTE CONTROLLER (PC-ARFC)

- 120mm square controller with LCD screen
- Multiple power-saving features
- Best option for spaces frequented by the same users, e.g. offices

SIMPLIFIED WIRED REMOTE CONTROLLER (PC-ARH1)

- Focused on easy operation
- Mainly for temperature setting
- Ideal for spaces that accommodate short-term visitors, e.g. hotels and hospital rooms

FROM BASIC TO ADVANCED CONTROLS

Advanced Colour Wired Remote Controller



PC-ARFG

Wired Remote Controller



HCWA10NEGQ

Simplified Wired Remote Controller



PC-ARC

Advanced Wireless Remote Controller



PC-AWR

Connection Capacity		RC Groups	1	1	1	-	
		Indoor units (*1)	16	16	16	-	
Setting	Temperature Setting Rate (*2)		0.5°C/1.0°C/1.0°F	0.5°C/1.0°C/1.0°F	0.5°C/1.0°C/1.0°F	0.5°C/1.0°C/1.0°F	
	Indoor Fan Speed (*2) (*3)		3/4/6 taps	3/4/6 taps	3/4/6 taps	3/4/6 taps	
	Louvre Direction (*2)		●	●	●	●	
	Individual Louvre Setting (*2)		●	●	●	-	
	Remote Control Primary-Secondary Setting		●	-	●	-	
	In Use of Total-Heat-Exchanger	Ventilation		●	-	-	-
		Total Heat Exchanger Setting		●	-	-	-
		Automatic Restart with Eco-operation		●	-	-	-
	Function Selection	Automatic Reset Temperature (Cooling)		●	●	●	-
		Temperature Indication (*4)		●	●	●	-
Admin Password Setting			●	-	-	-	
Service & Installation	Filter Signal		●	●	●	-	
	Filter Signal Reset		●	●	●	●	
	Louvre Open/Close		●	-	-	-	
	Room Name Setting		●	-	-	-	
	Alarm Signal		●	●	●	-	
	Side-by-side indoor unit identification		-	-	-	●	
	Hotel mode		●	-	-	-	
	Fan Speed at Thermo-Off (Cooling/Heating)		●	●(*7)	●(*7)	-	
	Screen	Screen Adjustment		●	-	-	-
		Use with AirCloud Tap (NFC)		●	-	●	-
		Use with wireless controller		-	-	-	-
		Temperature Unit °C/°F (*5)		●	●	●	●
		Run Indicator brightness adjustment		●	-	●	-
	Check Menu	Key touch sound		●	●	●	-
		Sensor Condition Check		●	●	●	-
		Sensor Data Check		●	●	●	-
		Model Display (*2)		●	-	-	-
		Indoor/Outdoor PCB Check		●	-	-	-
	Test Run	Alarm History Display		●	●	●	-
		Test Run		●	●	●	-
Function Selection (Optional Function Setting)			●	●	●	-	
Thermistor Selection			●	●(*7)	●(*7)	-	
Thermistor Calibration			●	-	●(*7)	-	
Input / Output Setting			●	●	●	-	
Indoor Unit Address Change			●	●	●	-	
Indoor Unit Address Operation Check			●	-	-	-	
Indoor Unit Address Initialisation			●	-	-	-	
Input / Output Setting Initialisation			●	-	-	-	
Compressor Pre-Heat Control Cancellation		●	-	-	-		
Contact Information Registration		●	-	-	-		
Management	Operation Lock/Set		●	●(*6)(*7)	●(*7)	-	
	Lower Limit for Cooling Operation		●	●(*7)	●(*7)	-	
	Upper Limit for Heating Operation		●	●(*7)	●(*7)	-	
	Simple Timer (On/Off)		●	●	●	●	
	Date/time setting		●	●	●	-	
	Automatic OFF Timer Setting		●	-	●(*7)	-	
	Schedule	Weekly Schedule		●	●	●	-
		Settable Timer Operation Times (Per Day)		5	1	1	-
Holiday Setting			●	-	-	-	
Schedule On/Off			●	-	●	-	
Power-Saving	Power-Saving with Motion Sensor		●	-	-	-	
	Outdoor Unit Capacity Control	Peak cut control		●	-	●	-
		moderate control		●	-	-	-
	Indoor Unit Rotation Control	Indoor Unit Address		●	-	-	-
		Indoor Air Temperature difference With Motion Sensor		●	-	-	-
Automatic Fan Operation		●	-	-	-		
Menu	Auto-Elevating Grille		●	-	-	-	
	ODU Night Quiet Mode		●	-	-	-	
	AutoBoost (quick function)		●	-	●	-	
	Comfort Setting	Control Cool Air (GentleCool)		●	-	●	-
		Direct/Indirect Louvre direction in COOL		●	-	-	-
		Direct/Indirect Louvre direction in HEAT		●	-	-	-
		Radiant Sensor Control for Heating		●	-	-	-
		FeetWarm; Heat Air Flow		●	-	-	-
	FloorSense; Cool Air Flow		●	-	-	-	
	Power Saving/Night Quiet Schedule		●	-	-	-	
	Filter Cleaning		●	-	-	-	
	FrostWash Setting		●	-	-	-	
	Daylight Saving Time		●	-	-	-	
	Setback (Hotel Temperature Setback)		●	-	●	-	
Power Consumption Display		●	-	-	-		

(*1) All 16 indoor units need to be connected with transition wire.
 (*2) Actual availability may vary depending on the indoor unit model connected to the controller. Please consult your Hitachi Cooling & Heating representative for more details.
 (*3) 6 steps available in RPIZ-HNDTSC compact ducted indoor unit only.
 (*4) Reference room temperature can be chosen: from indoor unit's air inlet thermistor or from the

thermistor built-in the controller itself.
 (*5) Please contact your distributor in case temperature unit needs to be changed from °C to °F.
 (*6) Only "bulk operation lock" available.
 (*7) Optional setting items for function selection.

Individual controllers

NEW ADVANCED COLOUR WIRED REMOTE CONTROLLER (PC-ARFG)

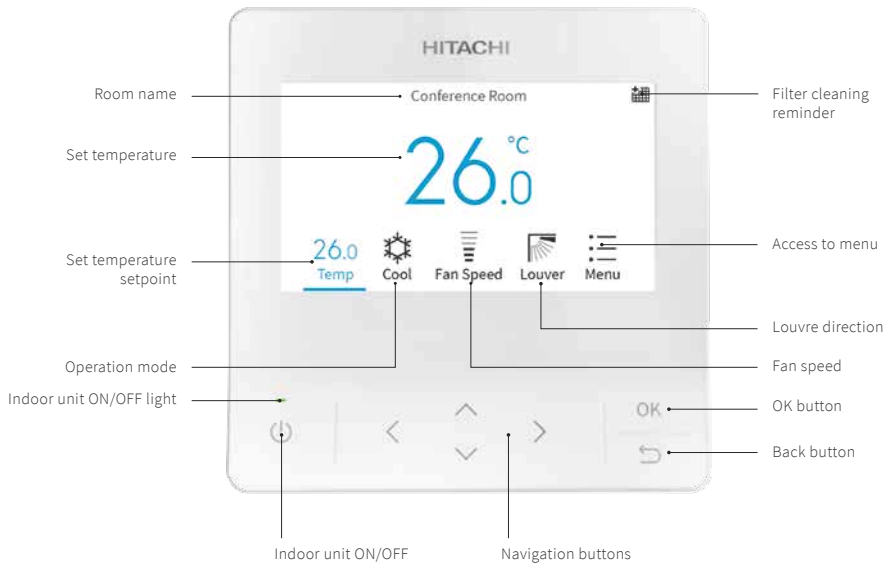

Outer dimensions (H×W×D)

121×120×16.5mm (thinnest)

121×120×21.5mm (thickest)



2021 Good Design Award, Australia
Product Design - Consumer Electronics

System configuration example

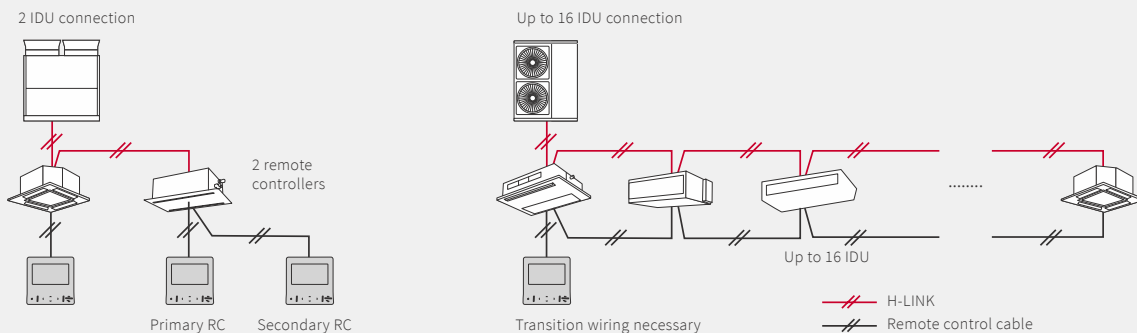

Functions

Function menu	Service and installation menu / Service	Service and installation menu / Installation
Simple Timer	Lock Function	Setting Initialisation
Operation Schedule	Password Setting	Main Remote Setting
Power-Saving Setting	Hotel Mode Set hotel mode valid/invalid	Priority Setting
Night Quiet Operation	Power-Saving Detail Setting	Cancel Preheating Control
Power-Saving/Night Quiet Schedule	Temperature Range Restriction	Elevating Grille Setting
Power Consumption Display	Dual Setpoint	Power Up Setting
Autoboost	Main/Sub Display	Setback Trigger Unit
Comfort Setting	Set Room Name	Check 1
Motion Sensor Setting	Set Contact Information	Check 2
Setback Setting	Simple Maintenance	Alarm History Display
Elevating Grille	Test Run	Display Model Number
Reset Filter Reminder Time	Function Selection	Units PCB check
Filter cleaning	Input/Output	Self Check
FrostWash™ Setting	Thermistor Selection	
Individual Louvre Setting	Thermistor Calibration in Controller	
Louvre Open/Close	Fan Speed at Thermo-Off (cooling/heating mode)	
Ventilation	Indoor Unit Address Change	
Total Heat Exchanger SET	Address Check Operation	
Adjust Date/Time	Address Initialisation	
Run Indicator Brightness		
Display Adjustment		
Temperature		
Language Setting		



Auto mode
(Colour: sand)



Outstanding design and user experience

With a sleek, award-winning design, our new advanced Colour controller offers elegance and ease-of-use. A simplified, intuitive and colourful interface makes controlling your ideal climate a breeze.

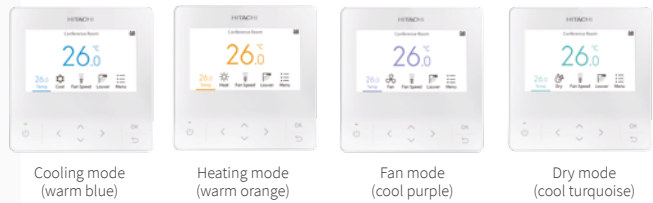

Cooling mode (warm blue) Heating mode (warm orange) Fan mode (cool purple) Dry mode (cool turquoise)

From basic to advanced functions

Adjust the air conditioning to enhance comfort and save energy with ease

- 1) Functions include **GentleCool**, which controls the temperature of discharged air, for smooth cooling down and cold drafts prevention. **AutoBoost** activates for 30 minutes every time the AC is turned on, helping the room reach the desired temperature faster with a powerful automatic mode.
- 2) AC scheduling is easier than ever, thanks to flexible options such as a holiday calendar.
- 3) Save even more energy with power-saving functions for VRF system operators. Cut peak capacity, rotate the thermal operation of indoor units, and use Hitachi's dedicated power-saving schedule to match your utility tariff plan.

Additional functions

- Activate, schedule and check the history of indoor units' FrostWash™ function
- Minimise outdoor unit noise at night with the schedulable quiet mode
- Hotel mode display provides quick access to the most popular AC functions for guests, including language selection.

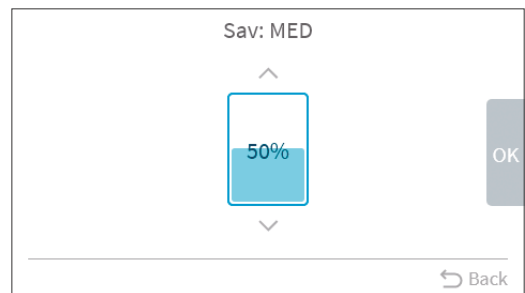

Capacity control setting

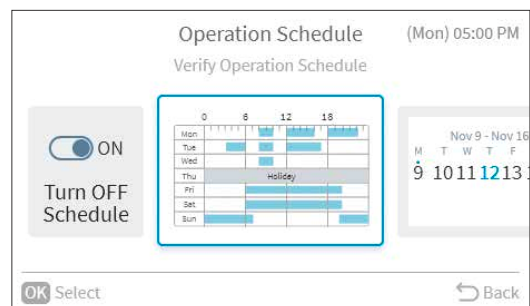

Schedule menu

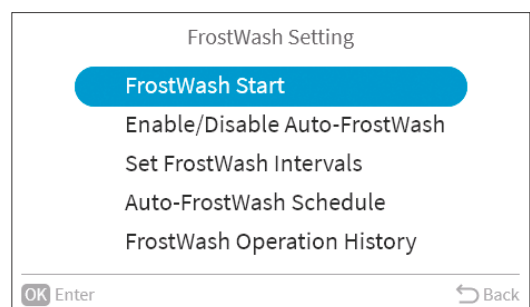

FrostWash menu

Individual controllers

WIRED REMOTE CONTROLLER (HCWA10NEGQ)

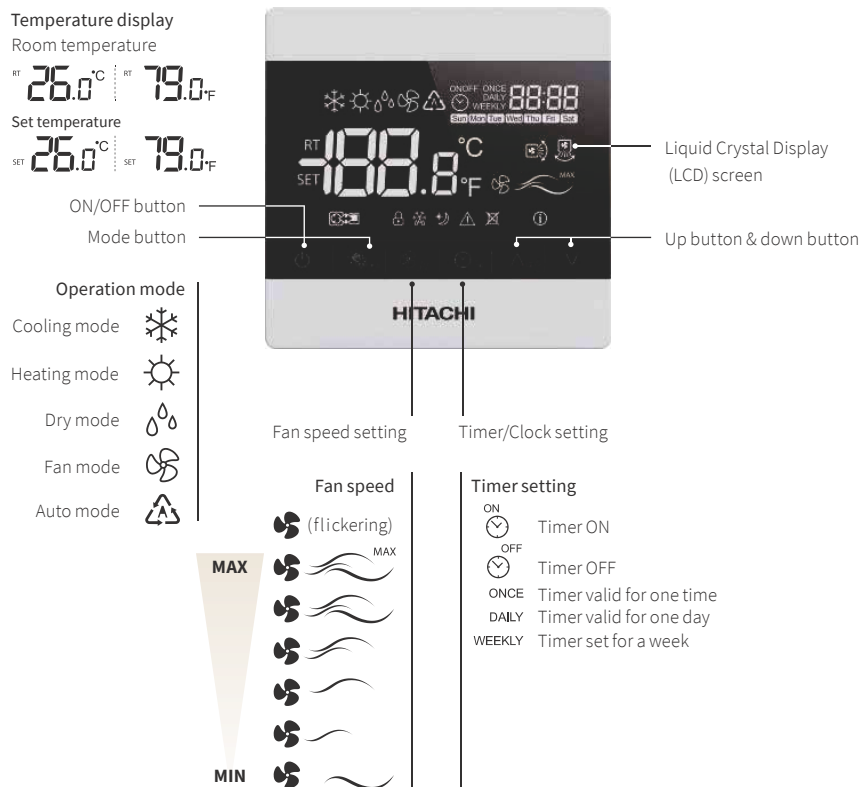

Outer dimensions (H×W×D)

(mm) 88.0×88.0×15.5

Functions

	Run/Stop
	Operation Mode
	Auto Mode Setting
Setting	Temperature Setting
	Temperature Setting Rate 0.5°C/1.0°C/1.0°F
	Back-light screen
	Fan Speed 3/4/6 taps
	Louvre Direction
	Key touch sound
Service	Sensor Condition Check
	Sensor Data Check
	Alarm History Display
Test Run	Test Run
	Function Selection (Optional Function Setting)
	Thermistor Selection
	Thermistor Calibration
	Input / Output Setting
	Indoor Unit Address Change
Management	Operation Lock/Set
	Lower Limit for Cooling Operation
	Upper Limit for Heating Operation
Schedule	Simple Timer (On/Off)
	Date/time setting

Notes:

1. Fan speed taps setting unit availability varies with the indoor unit. Please check each technical catalog in advance.
2. Initial setting of temperature display is "Set temperature" display only.

SIMPLIFIED WIRED REMOTE CONTROLLER (PC-ARC)



Outer dimensions (H×W×D)

(mm) 90.0×90.0×18.5

Functions

	Run/Stop
	Operation Mode
	Auto Mode Setting
Setting	Temperature Setting
	Temperature Setting Rate 0.5°C/1.0°C/1.0°F
	Back-light screen
	Fan Speed 3/4/6 taps
	Louvre Direction
Test Run	Function Selection (Optional Function Setting)
	Thermistor Selection
	Thermistor Calibration
	Input / Output Setting
Management	Operation Lock/Set
	Lower Limit for Cooling Operation
	Upper Limit for Heating Operation
	Automatic OFF Timer Setting

ADVANCED WIRELESS REMOTE CONTROLLER (PC-AWR)



Outer dimensions (H×W×D) (mm)

140.0×55.0×16.8

Functions

	Run/Stop
	Operation Mode
	Auto Mode Setting
Setting	Temperature Setting
	Temperature Setting Rate 0.5°C/1.0°C/1.0°F
	Fan Speed 3/4/6 Taps
	Louvre Direction
	Filter Sign Reset
Service	Side-by-side indoor unit identification
	Temperature Unit °C/°F
Schedule	Built-in Timer (On/Off)

RECEIVER KIT FOR WIRELESS REMOTE CONTROLLER

PC-RLH11 (Basic)



PC-ALHZ1 (Advanced)



Model

Indoor unit	Ducted High ESP (AC Motor)	Ducted Medium ESP (AC Motor)	Ducted Low ESP (AC Motor)	Ducted Compact		Ducted Larger Air Volume (AC Motor)	Wall-Mounted (DC Motor)	Floor / Ceiling Convertible (AC Motor)	Floor Concealed (AC Motor)
	RPI-HNAUNQ RPI-FSNQ	RPIM-HNAUNQ RPI-FSN3Q	RPIL-HNAUNQ	RPIZ-HNATNQ	RPIZ-HNDTSQ	RPI-FSN2SQ	RPK-HNBUSQ	RPFC-FSNQ	RPFI-FSNQ
Advanced Wireless Remote Controller PC-AWR	●	●	●	●	●	●	●	●	●
Standard Wireless Remote Controller PC-LH7QE	●	●	●	●	●	●	●	●	●

HR4A10NEWQ (Basic) | PC-ALH3 (Advanced) | PC-ALHC1 (Advanced) | P-AP56NAMR (Advanced) | PC-ALHD1 (Advanced) | PC-ALHS1 (Advanced) | PC-ALHP1 (Advanced) | PC-ALHZ1 (Advanced)

Model

Indoor unit	4-way Cassette (DC Motor)	4-way Cassette (DC Motor)	4-way compact Cassette (AC Motor)	4-way compact Cassette (AC Motor)	2-way Cassette (DC Motor)	1-way Cassette (DC Motor)	Ceiling Suspended (DC Motor)	Wall-Mounted (DC Motor)	Floor Exposed (AC Motor)	Floor Concealed (AC Motor)	Ducted High ESP (DC Motor)	Ducted Medium ESP (DC Motor)
	RCI-FSKDNQ	RCI-FSRP	RCIM-FSRE	RCIM-FSRE	RCD-FSR	RCS-FSR	RPC-FSR	RPK-FSRM RPK-FSRHM	RPF-FSN2E	RPFI-FSN2E	RPI-FSR RPI-FSN1	RPIM-FSR
Advanced Wireless Remote Controller PC-AWR	●	●	●	●	●	●	●	●	●	●	●	●
Standard Wireless Remote Controller PC-LH7QE	●	—	—	—	—	—	—	—	—	—	—	—

Basic Limited function available for centralised controllers
Temperature setting rate [1.0°C] only

Advanced Full function available for centralised controllers
Temperature setting rate [0.5°C/1.0°C/1.0°F]

(*) Basic function receiver kit is installed as a standard part in this wall-mounted unit. Wireless remote controller (PC-LH7QE) is delivered as a standard accessory as well. If separate placement of receiver kit is required, please use optional basic receiver kit [PC-RLH11] or optional advanced receiver kit [PC-ALHZ1].

Notes:
When using a basic receiver kit PC-RLH11 or HR4A10NEWQ together with wireless remote controller PC-LH7QE:
1) It won't be possible to lock individual remote controllers from Hitachi Central Stations (mini/EZ/EX)
2) It won't be possible to apply min/max restrictions on set temperature from Hitachi Central Stations (mini/EZ/EX)

Accessories



3P CONNECTOR CABLE PCC-1A

FOR CONNECTION TO REMOTE ON/OFF DEVICE/RECEIPT OF OUTPUT SIGNAL

Operation example

•Cooling operation:

Compressor is ON by closing terminals 2 and 3 of CN3.

Compressor is OFF by opening terminals 2 and 3 of CN3.

•Heating operation:

Compressor is ON by closing terminals 1 and 2 of CN3.

Compressor is OFF by opening terminals 1 and 2 of CN3.

*One set contains five 3P connector cables.

*PCC-1A can connect to external signal input-output terminal both in outdoor unit and indoor unit.

System configuration example

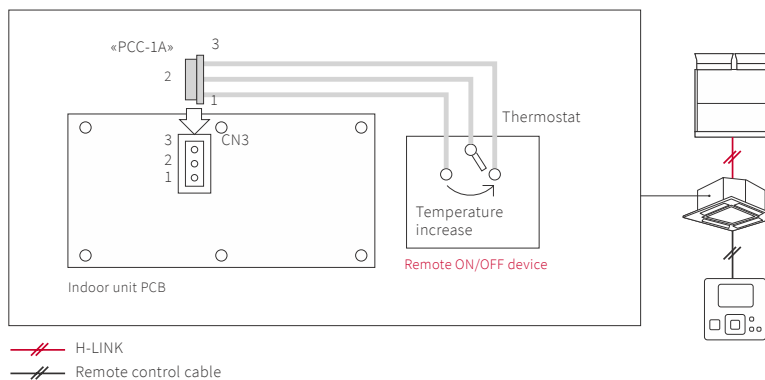

REMOTE SENSOR THM-R2A

ROOM TEMPERATURE SENSOR

Outer dimensions (H×W×D)

(mm) 50.0 × 50.0 × 15.0

Length m 8.00

System configuration example

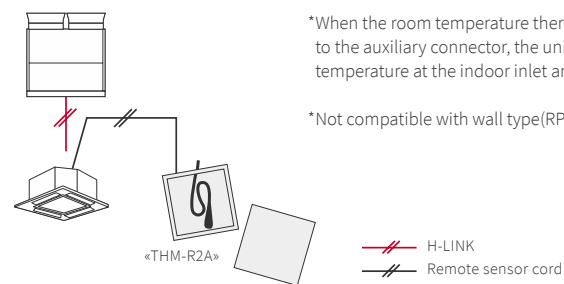

*When the room temperature thermistor (remote sensor) is connected to the auxiliary connector, the unit is controlled at average air temperature at the indoor inlet and remote sensor point.

*Not compatible with wall type(RPK) indoor unit.



BMS ADAPTER for BACnet® HC-A64BNP1

CONTROL UP TO 64 INDOOR UNITS

Specifications

Outer dimensions (H×W×D)
(mm) 68.0×240.0×154.0

Functions

Corresponding BACnet® Standard	ANSI/ASHRAE Standard 135-2004 BACnet®
Control Item at Upper System	<ul style="list-style-type: none"> • Run Stop (Setting) • Operation Mode (Setting) • Fan Speed Level (Setting) • Indoor Temperature (Setting) • RC Operation lock (Setting) • Filter Sign Reset
Monitoring Item at Upper System	<ul style="list-style-type: none"> • Run Stop (State) • Operation Mode (State) • Fan Speed Level (State) • Indoor Temperature (State) • Prohibiting RC Operation (State) • Filter Signal • Indoor Air Intake Temperature • Alarm Signal • Alarm Code • Communication State

System configuration example

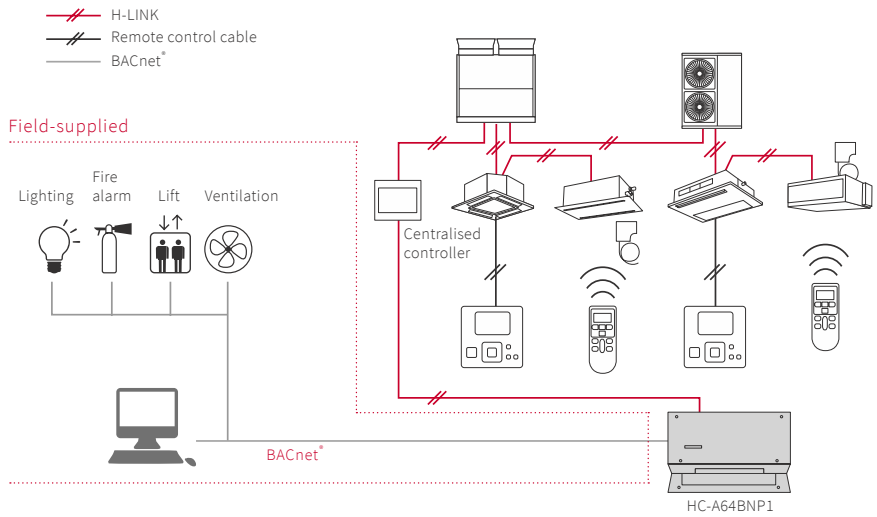

H-LINK: enjoy more freedom

WHAT IS H-LINK?

H-LINK is Hitachi Cooling & Heating's original communication system to control multiple VRF refrigerant systems from one centralised control point.

H-LINK simplifies commissioning and service maintenance for installers and service engineers. For building owners and occupants, it provides outstanding versatility enabling the connection of various types of central control options, enabling better system management.

Our proprietary high-performance communication system enables the connection of control wiring between indoor and outdoor units, and between a centralised control system and indoor/outdoor units across two or more refrigerant systems.

Examples



Educational institutions such as primary schools where installation work cannot be performed on weekdays.



Hotels where it is preferable to complete installation work during late evenings.



Rehabilitation facilities or hospitals where it is necessary to minimise the burden on users.

3x
more
benefits!

1

Flexible wiring routes:
no restrictions &
time-saving
at installation

2

**Can connect with various
types of Hitachi air
conditioning products**
including VRF and mini splits
for centralised controls

3

**No adapter
is needed!**
Simple connection
to terminal blocks

Definition of terms in Hitachi centralised control systems

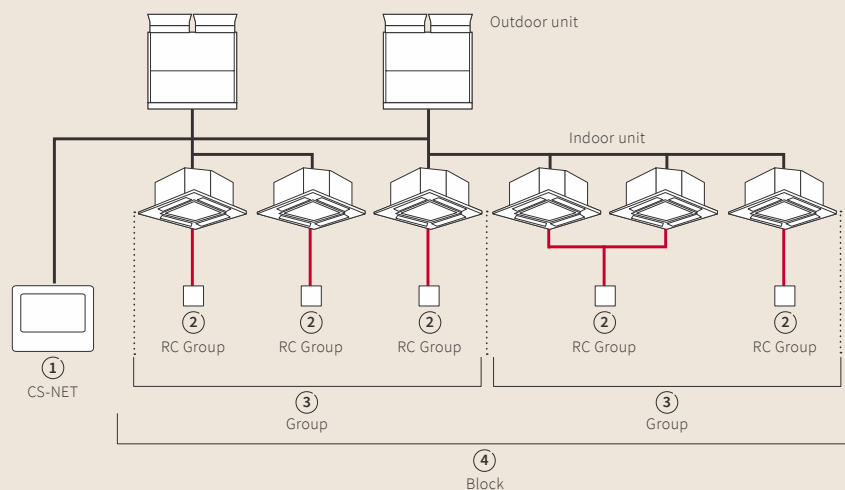

① **CS-NET/Central station**

Hitachi original centralised controller

② **RC Group (Remote Controller System Group)**

A number of indoor units (up to 16 units) connected using "same remote controller" wiring. In this group, connected indoor units are all controlled in the same way.

③ **Group**

The multiple "RC groups" that are registered in the centralised controller network setting.

④ **Block**

The multiple "groups" that are registered in the centralised controller network setting.

CENTRALISED CONTROLS: FLEXIBLE WIRING ROUTE

- (1) • Multiple refrigerant systems located in one area.
- Central monitoring room in separate area.

H-LINK SOLUTION

- Wire the central station to the closest indoor unit.
- Wiring distance is reduced substantially.

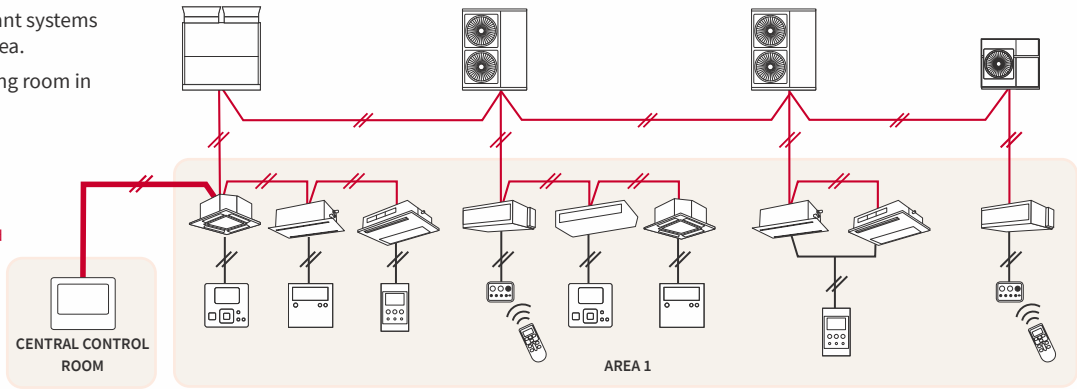

- (2) • Refrigeration systems in different places.
- Some indoor units of each respective system are close to one another.

H-LINK SOLUTION

- Where two indoor units of each respective system are close together, you can connect two refrigerant systems via the indoor units.
- Wiring distance is reduced substantially.

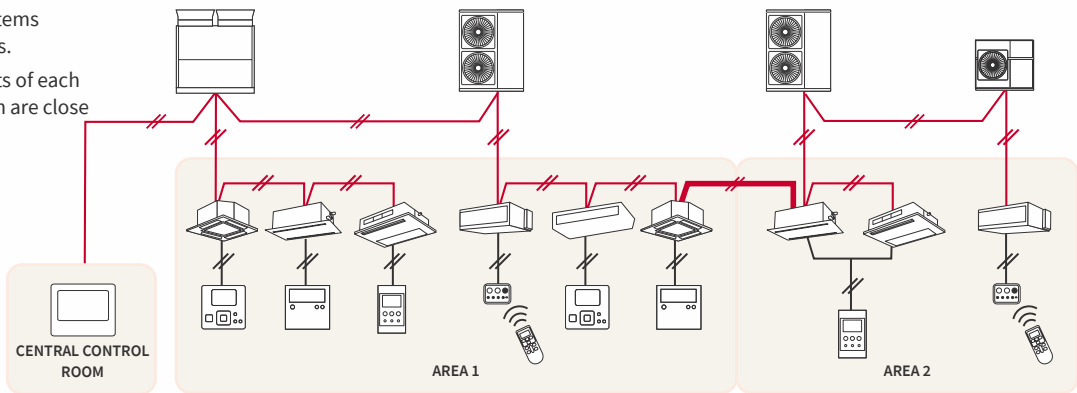

- (3) • One refrigerant system far away from the remaining ones.

H-LINK SOLUTION

- Connect the farthest refrigerant system directly to central station either to outdoor units or indoor units.
- The central station can make the central link between the different refrigerant systems.

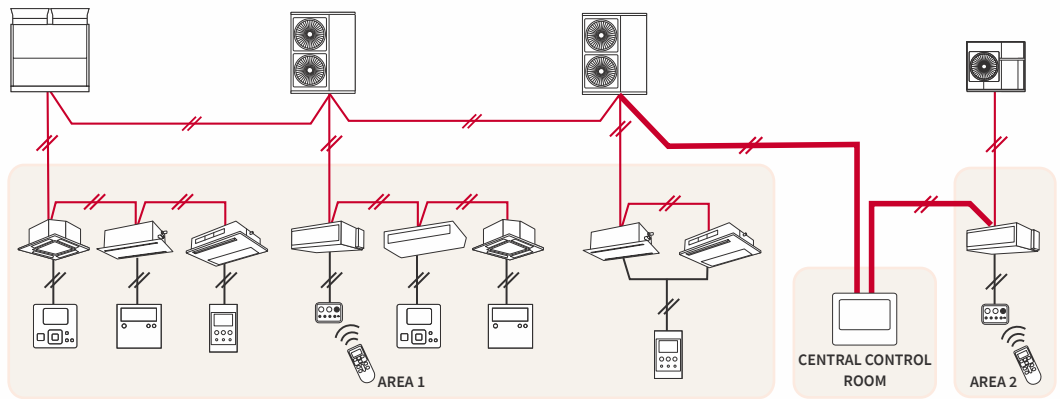

- (4) • Each refrigerant system in separate areas.
- Indoor units are closer from one group to another.

H-LINK SOLUTION

- Centralised control can be achieved by connecting the refrigerant systems via the closer indoor units.
- Wiring can be indoors only.

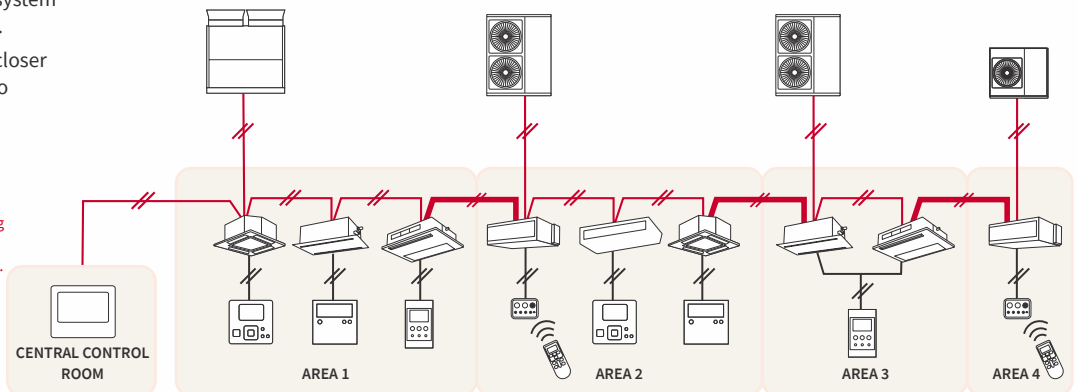

—//— H-LINK solution

—//— H-LINK

—//— Remote control cable



Temperzone Ltd

ENQUIRIES

nzsales@temperzone.com

NEW ZEALAND

Auckland: (09) 279 5250
Hamilton: (07) 839 2705
Wellington: (04) 569 3262
Christchurch: (03) 379 3216

AUSTRALIA

Sydney: (02) 8822 5700
Melbourne: (03) 8769 7600
Brisbane: (07) 3308 8333
Adelaide: (08) 8115 2111

CERTIFICATE

Outdoor Unit Manufacturing Site: Johnson Controls-Hitachi Air Conditioning Wuhu Co., Ltd.
Concerning Hitachi Slim-Modular VRF SideSmart



hitachiaircon.co.nz

SOCIAL MEDIA



The specifications of this catalog may change without prior notice to allow Hitachi Cooling & Heating to incorporate the latest innovations for its customers. The information contained in this catalog is merely informative. Hitachi Cooling & Heating declines any responsibility in the broadest sense, for damage, direct or indirect, arising from the use and / or interpretation of the recommendations in this catalog.