

# OPA 250–560 RLTFP-DZ (Econex) c/w Economiser & Viking Air Cooled Packaged Units - Reverse Cycle - R32 Installation & Maintenance

## CONTENTS

	Page
1. GENERAL .....	1
2. INSTALLATION .....	2
3. REFRIGERATION SYSTEM.....	2
4. CONTROLS .....	3
5. START-UP PROCEDURE.....	3
6. OPERATION.....	4
7. MAINTENANCE.....	7
8. TROUBLESHOOTING .....	7
9. WARRANTY .....	8
10. UC8 CONTROLLER DISPLAY .....	8
11. VIKING CONTROLLER : FACTORY SETTINGS .....	8
APPENDIX I : PROTECTION FUNCTIONS .....	9
APPENDIX II : AIR HANDLING PERFORMANCE.....	11
COMMISSIONING CHECK LIST .....	12

## 1. GENERAL

Temperzone OPA Outdoor Air Cooled Packaged units.

Follow these instructions to ensure the optimum performance, reliability and durability.

Units must be installed in accordance with all national and regional regulations and bylaws. National Health and Safety regulations must be followed to avoid personal injuries.

The appropriate local permits must be acquired and adhered to.

Local regulations on maximum boundary noise need to be considered when positioning the unit.

The Economiser/Viking functionality of the unit is designed to comply with Australian National Construction Code (NCC 2022) and NZ Building Code H1/VM3 which specifies the Enthalpy Method of operation for energy efficiency.

The accompanying 'R32 Handling Ducted Packaged Units' pamphlet forms part of these Installation & Maintenance instructions.

### **⚠ WARNING**

**These units use R32 refrigerant (Class A2L) which is mildly flammable.**

The system shall be installed, operated and stored in a well ventilated space. If the refrigerant gas comes into contact with fire, a poisonous gas may occur. Be aware that R32 does not contain an odour.

If indoors, the appliance shall be stored in a room away from continuously operating sources known to cause ignition of R32 refrigerant (for example an operating gas appliance or operating electric heater)

This appliance is not intended for use by persons (including children) with reduced physical, sensory, or mental capabilities, or lack of experience and knowledge, unless they have been given supervision or instruction concerning use of the appliance by a person responsible for their safety. Children should be supervised to ensure that they do not play with the appliance.

## 2. INSTALLATION

### 2.1 Clearance

Refer to diagrams below and in supplied Specifications document for minimum clearances.

Figure 1. Clearances

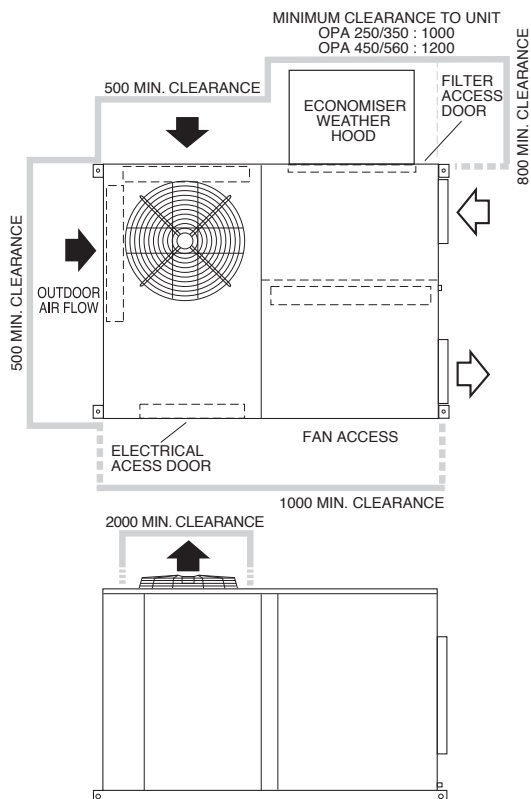

#### Plant Room Installation

Ensure sufficient ventilation is installed. Discharge air from above the unit must be ducted away to prevent recirculation of air through the unit. Restricted airflow and/or recirculation reduces efficiency. Never install the unit in a totally enclosed room.

### 2.2 Economiser Weathercowl

The Economiser weathercowl (weatherhood) is supplied in kitset form and must be assembled, then fitted to the unit – usually before the unit is lifted into place (refer separate kitset instructions). Screws and pre-drilled holes are provided. Ensure all joints are sealed with silicon sealant. There must be at least 300mm clearance beneath the cowl once it is fitted in place. Ensure the fitted cowl is not damaged when unit is lifted into position.

### 2.3 Mounting

The unit should be fastened to a firm flat horizontal base using the holes supplied in the mounting channels, or using universal beam clamps. When the unit is being installed on a roof it is recommended that the unit is installed on a substantial structure with vibration isolating mounts or pads.

Flexible duct connections are recommended between the supply and return ducts and the unit.

The unit is shipped with blocks installed under the compressors. Ensure these blocks are removed from the compressor feet prior to starting the unit (not required for operation).

Factory filter frames are fitted. Access to the filters is via the return air access door.

### 2.4 Condensate Drains

Condensation can form on both the indoor and outdoor air coils. This is normal during unit operation. It is recommended the condensate be piped to a suitable drainage point to prevent ponding and/or slippery mould growth around the base of the unit.

An optional outdoor coil drain tundish is available (part 060-000-635) with 25mm OD stub. Alternatively, for a drip free installation a separate drain tray beneath the unit could be used to drain condensate to a suitable drainage point.

Condensate drains should be 'U' trapped outside the unit. The trap should have a vertical height of at least 100 mm. The drain should have a slope of at least 1 in 50 and must not be piped to a level above the unit drain pipe. (refer fig. 2)

Figure 2. Condensate Drains

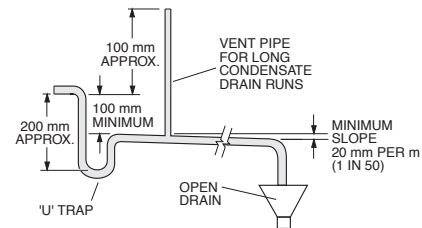

## 3. REFRIGERATION SYSTEM

### 3.1 General

These OPA models each have a single inverter compressor to provide the flexibility and economy of variable speed operation. The compressor is very efficient at part load.

The refrigeration system has been charged with R32 refrigerant; refer Specifications document for amount.

### 3.2 Compressor

The compressor is an inverter scroll type. The compressor lubricant is polyolester oil (POE). Note, this oil absorbs moisture quickly if exposed to open air.

### 3.3 Economiser

When the outdoor air heat content (enthalpy) is below that of the return air, the fresh air damper will open and the return air damper close to provide the first stage of cooling. A spill air facility in the building may be necessary for when the return air damper is closed. The fresh air damper should return to minimum setting and the return air damper open before the compressors are allowed to operate to provide further cooling. Refer Section 6.3 for more information.

### 3.4 Fresh Air

Air flow through the damper should not exceed 25% of the OPA unit's nominal air flow. Excessive amounts of low ambient fresh air will reduce the performance of a reverse cycle OPA unit especially on heating cycle. Fresh air should be adjusted to meet CO<sub>2</sub> sensing requirements, if applicable.

The damper setting is dependent on the return air duct static pressure and the design air flow for the specific installation. It is recommended an air flow balance commissioning contractor be utilised. Too much fresh air introduction may void the OPA unit's warranty.

### 3.5 Pressurised Compartment

The compressor/electrical compartment can be pressurised with indoor supply air. This assists in keeping dust out of the compartment. Two plastic bungs are located near the top of the common side-wall (refer Figure 3). Remove only the bungs applicable to your type of unit – standard or opposite hand; not both sets.

Figure 3. Pressurisation bung locations

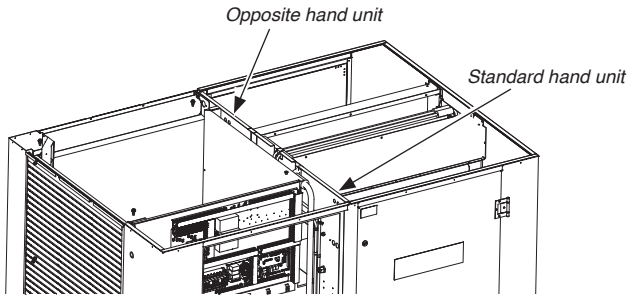

## 4. CONTROLS

### 4.1 Electrical Requirements

Electrical work must be done by a qualified electrician.

**DANGER! LIVE ELECTRICAL CONNECTIONS. DISCONNECT MAINS POWER BEFORE WORKING ON UNIT. ONLY QUALIFIED PERSONS WHO ARE COMPETENTLY TRAINED SHOULD PERFORM SERVICE AND MAINTENANCE TASKS.**

The outdoor unit must be wired directly from a distribution board by means of a circuit breaker and a mains isolator provided – preferably close to the unit.

A 24 hour power supply to the compressor crank case heaters is required, otherwise the warranty is void.

### 4.2 Control options

These OPA Econex (-DZ) units are controlled using the Smart Temp RS-SSD wall control (indoor Smart Sensor).

Other options include the following:

- 24V AC and 0-10V signals from an external controller or thermostat
- Remote on/off switch and/or time clock
- Modbus RTU serial communications over RS485 connection
- BACnet-IP serial communications over Ethernet connection (with optional gateway module)

Standard reverse cycle units are suitable for use with thermostats and controls with manual heating/cooling selection or automatic change-over.

A unit wiring diagram is supplied alongside the electrical board and in the Specifications document.

### 4.3 Remote on/off

The UC8 has an input for a remote on/off function on terminal 'On', signal return is terminal '0V'. When used the remote on/off terminals should connect to a voltage-free relay contact. When not used the remote on/off terminals should be shorted ('bridged') – refer wiring diagram.

### 4.4 Capacity control

OPA Econex units offer the following capacity control options:

- Automatic control when the unit connects to the RS-SSD wall control.
- 0-10V compressor control signal via terminal 'VC' on the UC8 circuit board, signal return is terminal '0V'.
- 0-10V indoor fan control signal via terminal 'VF' on the UC8 circuit board, signal return is terminal '0V'.
- Control by a building management system via Modbus RTU or BACnet-IP serial communications.

### 4.5 Unit Controller (UC8)

The unit's UC8 controller receives requests such as 'Unit On/Off', 'Start compressors', 'Activate HEAT (Reverse Cycle)' and transfer the requests to the outputs after enforcing safety timers.

Figure 4. UC8 Controller

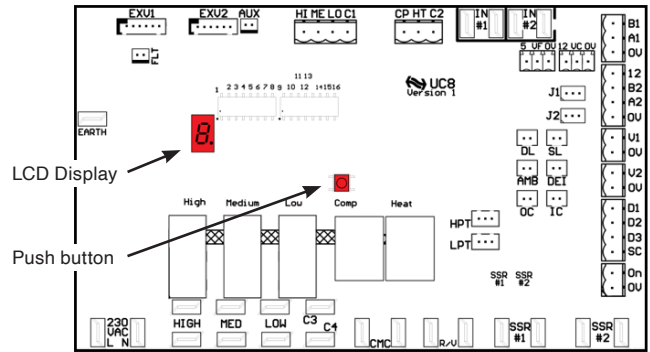

The Unit Controller provides several system protection functions. These are covered in Appendix I (p.9).

For additional information, refer to the UC8 Controller label on the unit or [www.temperzone.biz](http://www.temperzone.biz) for operation & fault diagnostics information; model search 'UC8'.

References available:

- UC8 Operation Manual : Air-to-Air Units
- UC8 Fault & Display Messages (as per unit label)
- UC8 Quick Reference and Operation Fault Diagnosis
- UC8 Troubleshooting Guide
- UC8 Modbus Communications
- UC8 BACnet Communications
- UC8 Master-Slave Connection

### 4.6 Viking Controller for Economiser/Economy Cycle

OPA Econex (-DZ) units utilise: (i) Viking SMT-920 HVAC Controller, (ii) RS-SS outdoor air temp. & humidity sensor, and (iii) RS-SSD wall control (aka indoor Smart Sensor).

Air Quality (CO<sub>2</sub>) sensors, 0–10V, are available to work with this Controller.

The controller is factory set for 'Enthalpy control' to comply with Australian NCC and NZ Building Code.

Refer Section 6.3 Operation for more information.

### 4.7 Viking/Smart Temp RS-SSD wall control

Connect the RS-SSD to the unit using a shielded twisted pair type cable, suitable for RS485 communications. Signal wires 1 and 4 should form one twisted pair.

**Note:** The cable shield must be connected to a suitable Earth. Do not connect at both ends.

RS-SSD has its own DIP switches that are factory preset, as per OPA unit wiring diagram.

Connect the thermostat as follows:

#### RS-SSD Connection:

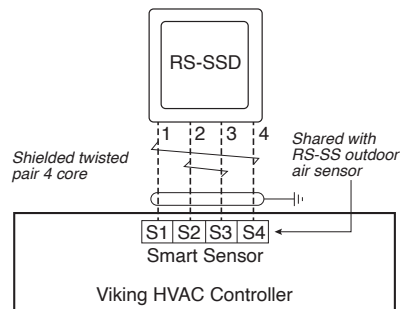

Note: The RS-SSD can not be used simultaneously with a 2-wire remote sensor.

Refer RS-SSD Manual for installer options and use.

#### 4.8 Control using switched and 0-10V signals

An external controller that provides 24V AC switched signals or has a set of voltage-free relay contacts should be connected as per the diagram below. UC8 inputs 'VF' and 'VC' will accept a 0-10V capacity control signals. If no capacity control signal is available then link UC8 terminals 'VF' and '5' and 'VC' and '12'.

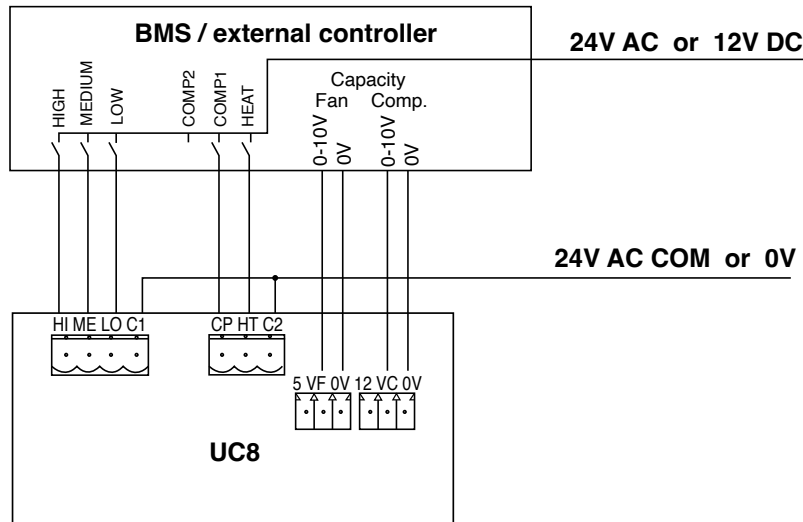

#### 4.9 Control via Modbus RTU communications

OPA Econex units can be fully monitored and controlled via Modbus RTU serial communications. The following is typical for most installations:

- Set DIP switches 11 and 12 to OFF on all UC8 controllers.
- Connect BMS terminal A / TX+ to terminal A1 on the UC8 controller via terminal block shown.
- Connect BMS terminal B / TX- to terminal B1 on the UC8 controller via terminal block shown.

Multiple OPA units can be daisy-chained together. For detailed information about monitoring and control via Modbus RTU refer to document 'UC8 Modbus communications', available at [www.temperzone.biz](http://www.temperzone.biz) (model search 'UC8') or .com website.

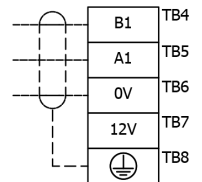

Connect cable screen to 'EARTH' terminal

#### 4.10 Setting the UC8 Modbus device address

To view or change the Modbus device address of a UC8 follow these steps:

- Power up the unit but leave the compressors off.
- Hold down the SW3 pushbutton on the UC8 circuit board until the display shows: '0' [release] → '1' → short press to '2,' [long press] → A, [long press]
- The display will show the current Modbus device address. The factory default address is '44'. [Short press] the button to select higher numbers, for example press once to change the address to 45, press twice for address 46 and so forth. [Long press] to save the chosen address. After address 99 the number returns back to 1.
- The controller returns to the default state (– ●).

## 5. START-UP PROCEDURE

### 5.1 Before starting the compressor

1. Before working on the unit remove mains power from the unit by opening the mains isolating switch.
2. Remove the shipping blocks from beneath each compressor. Check that each compressor is securely mounted.
3. Check the thermostat and/or other controls are correctly wired to the unit.
4. Check tightness of electrical connections.
5. Check the air filters have been correctly installed, if present.
6. Check that all indoor fan motors can freely rotate.
7. Apply mains power to the unit by closing the mains isolating switch.
8. Check the supply voltage between each phase and neutral.
9. Check air diffusers are open.
10. Before starting the compressors a four hour delay period is required to allow the crankcase heaters to drive any liquid refrigerant out of the compressor oil. Mains power must be switched on during this four hour delay period.

### 5.2 Commissioning

After the four hour delay period has expired (see step 10 in section 5.1) complete the following procedure. You can use the Commissioning Sheet (refer back page) to help you.

1. Place the UC8 controller in commissioning mode by pressing and holding the SW3 push button (see Fig. 4) until the display shows:  
'0' [release] → '1' [long press] → 't'; [short press] repeat to find 'c', then [long press] to select.  
This Commissioning mode 'c' reduces the waiting times at start-up and between cycles for the next half hour, or until the controller is reset by removing  power.
2. Start compressor in Cooling mode.
3. Check the outdoor fan motor runs smoothly.  
*Note: The outdoor fan does not necessarily start rotating immediately after the compressor is started. The fans may run-on for a short period after the compressor stops.*  
Outdoor fan stops during outdoor coil de-ice cycles.
4. Measure the current draw on each phase to the compressor motor and to each fan motor. Check the readings against the specified values in the specification sheet.
5. The display and pushbutton on the UC8 can be used to check temperatures and pressures. Short presses on the pushbutton cycles through the available options. **Table 1** on page 8 shows, in sequence, what information is available – with examples.

Alternatively use a set of pressure gauges suitable for R32 refrigerant.

#### ⚠ WARNING

Under no circumstances shall potential sources of ignition be used in the searching for or detection of refrigerant leaks. If a leak is suspected, all naked flames shall be removed/extinguished.

If a leakage of refrigerant is found which requires brazing, all of the refrigerant shall be recovered from the system, or isolated (by means of shut-off valves) in a part of the system remote from the leak.

6. Repeat steps 2 to 5 for each compressor.
7. Test operation of the compressors when operating in heating mode.
8. Check for desired supply air flow rate at each outlet.
9. Touch up any outdoor unit paintwork damage to prevent corrosion.
10. Sign the check label.

### 5.3 Commissioning of variable speed (EC) indoor plug fan

A unit equipped with variable speed (EC) indoor plug fan allows adjustment of the fan speed to obtain the desired indoor supply airflows.

#### Using RS-SSD

If the unit is controlled with the Smart Temp RS-SSD wall control then adjustments are made as follows:

- i. Ensure the compressor is off and the thermostat or BMS does not request for the compressor to start. The UC8 display should show a flashing dot (●).
  - ii. To adjust the fan High speed press and hold down the SW3 push button on the UC8 circuit board until the display shows:  
'0' [release] → '1' [long press] → 't'; [short press] repeat to find 'H', then [long press] to select.
  - iii. The fan will start and run at High speed. The display shows the fan control voltage for the High speed setting; factory default value is 8.0V. 
  - iv. Each following press on the SW3 push button increases the indoor fan control voltage in steps of 0.5V, up to a maximum of 10.0V. Pressing the push button again when value 10.0 is shown returns the fan control voltage down to the minimum value of 3.0V and back up again.
  - v. When the desired setting for high fan speed is displayed, [long press] to select and save. The controller then exits the menu and the fan stops.
  - vi. To adjust the fan Low speed hold down the SW3 push button on the circuit board until the display shows:  
'0' [release] → '1' [long press] → 't'; [short press] repeat to find 'L', then [long press] to select.  
The fan will start and run at the Low speed setting. The factory default value is 5.0V.
  - vii. Repeat steps (iv) and (v) to adjust the fan Low speed setting. The minimum control voltage for Low speed is 1V and the maximum control voltage for Low speed is 8V. (Note: A 'low' control voltage of less than 2V is not recommended.) If 'low' is set higher than 'high', the 'high' is made equal to 'low'.
- c. Check if the High speed airflow is to specification.

#### Note:

*If fan speed selections are different from the factory default values then the procedure above must be carried out for the UC8 controller.*

*It is allowed to make the control voltages for low and high fan speed equal. This makes the indoor fan act as a fixed speed fan.*

*It is allowed to control the indoor fan speed by an external source, independent of the UC8 controller. It is then the responsibility of the system-designer and installer to ensure proper and safe operation of the indoor fan, and the system as a whole, under all operating conditions.*

*Setting the indoor fan speed too low can bring risk of frost forming on the indoor coil with potential nuisance frost protection trips on cooling, possibly even unit lock-out, and/or HP trips on heating.*

*continued...*



Setting the indoor fan speed too high can bring a risk of any condensation being sucked off the fins of the indoor coil and into the supply air duct. Water could then start leaking from the supply air vents and diffusers and corrosion of ducting may occur.

Setting the indoor fan speed too high can also bring a risk of 'over-condensing' (when the unit is heating) which in turn could cause the unit to perform more outdoor coil de-ice cycles than necessary.

Refer Appendix II Air Handling graphs for min./max. airflows.

## 6. OPERATION

### 6.1 User Operation (RS-SSD)

The temperature +/- buttons adjust the room set temperature. (You can limit the range of user adjustment by setting the heating and cooling control limits in the Installer menu of the Viking Controller.)

The Select button toggles the LCD display between current 'room' temperature, 'set' temperature, inside relative humidity (RH), outside temperature and outside RH.

The After Hours button starts (or cancels) the after hours run timer.

The LCD will also provide other information such as whether there are any faults, and if outside air is being used for economy cooling, etc.

### 6.2 Scheduling

The Viking HVAC Controller, in the unit, can be programmed to operate at different time intervals:

- Always On
- Manual (default)
- 7 Day, 1 Event
- 7 Day, 2 Events
- 365 Day, 1 Event
- 365 Day, 2 Events
- After Hours (2 hours default)
- Daylight Saving Time (DST)
- Holidays

Refer to the Viking User & Installer Manual for more information and Schedule set-up instructions.

**Note: RS-SSD can not be used as an interface to program the Schedule.**

### 6.3 Safety Timers

The UC8 receives control signals and transfers the signals to the outputs after enforcing safety timers and other protection functions. If the compressor is held off, or held on, by a safety timer then the display shows message 'H-O-L-d'.



Normal durations of safety timers are:

- Minimum off time 3 minutes
- Minimum run time 1.5 minutes
- Min. cycle time 6 minutes (up to 10 compressor starts per hour)
- Min. mode change-over time 10 minutes (cooling to heating or vice-versa)

### 6.4 Variable Capacity

The OPA unit is equipped with a single variable capacity compressor – inverter scroll type. Compressor operating capacities are 16%–100% using 1.6V–10V control voltages.

At any time, when operating conditions dictate, system protection functions can restrict unit operating capacity.

When a capacity signal is presented that is lower than the minimum capacity (for example 0V on input 'VC') then the compressor operates on minimum duty.

If a unit operates on low capacity for extended periods then the unit may periodically perform oil flush cycles. Under such operating conditions compressor lubricating oil may slowly settle in parts of the refrigeration system other than the compressor. Oil flush cycles help to return the lubricating oil to the compressor. During an oil flush cycle compressor speed is increased for a duration of 1 minute.

Variable capacity indoor air fan – Refer Section 5.3

### 6.5 Economiser / Economy Cycle

The Economy Cycle function has been pre-set. No on-site Installer setting is required.

The Economiser package fitted consists of two opposed blade dampers – one for fresh air intake and one for indoor return air. A 0–10V dc control signal drives the dampers open and closed. This signal comes from the Viking HVAC temperature/humidity controller. The return air damper will close proportionally as the fresh air damper opens proportionally and vice versa.

The control strategy is by Enthalpy (ie a combination of dry and wet bulb temperatures) so that free cooling is used without adding any heat load to the building. This is a requirement of Australian NCC and NZ Building Code.

The Viking will shut the F/A damper automatically to the minimum 'stop' setting when it outdoor humidity is too high (ie raining) to prevent moisture being drawn into the unit

When Economy Cycle is not operating, the maximum amount of fresh air should not exceed 25% of the unit's nominal airflow.

The fresh air damper's adjustable stop can be set such that it does not close 100%. Many installations require a minimum fresh air introduction of 10 – 15% and the stop may be set on site to facilitate this. Set the Fresh Air damper motor 'stop' to the equivalent negative static pressure as with F/A damper closed. This is to ensure the air flow volume remains constant and does not dramatically increase when introducing fresh air.

*Demand Control Ventilation:* Air Quality (CO<sub>2</sub>) sensors can be used to proportionally control the fresh and return air dampers (via the Viking control system).

In all situations the UC8 Unit Controller will allow the compressors to operate with the fresh air damper open providing the refrigeration system is not compromised.

The compressor(s) could be stopped from operating by normal protection devices such as low suction temperature/pressure or indoor coil frost protection and too many trips of either fault could lead to a lock out of the compressor(s) operation. Should this occur then a review of the control settings may be necessary.

---

## 7. MAINTENANCE

WARNING! HAZARDOUS VOLTAGE. ENSURE ALL POWER SUPPLIES ARE ISOLATED BEFORE PERFORMING MAINTENANCE. FAILURE TO ISOLATE POWER CAN LEAD TO SERIOUS INJURY.

### 7.1 Monthly

1. Check air filters, if fitted, and vacuum or wash clean as necessary.
2. Check condensate drain for free drainage.
3. Check compressor compartment for oil stains indicating refrigerant leaks.

#### ⚠ WARNING

Under no circumstances shall potential sources of ignition be used in the searching for or detection of refrigerant leaks. If a leak is suspected, all naked flames shall be removed/extinguished.

If a leakage of refrigerant is found which requires brazing, all of the refrigerant shall first be recovered from the system.

4. Check system operating pressures via the UC8 (refer Section 5.2.5).

### 7.2 Six Monthly

1. Check the tightness of electrical connections.
2. Check for signs of corrosion on electrical connections in high salt atmospheres; replace where necessary.
3. Check the tightness of all fans, motor mountings.
4. Check system operating pressures via the UC8 (refer Section 5.2.5).
5. Check and/or replace indoor air filters
6. Check condensate drain for free drainage.

### 7.3 Yearly

1. Check all refrigerant piping for chafing and vibration.
2. Check the operation of electric heaters, if fitted
3. Check air supply at all diffusers
4. Check for excessive noise and vibration and correct as necessary.
5. Check for insulation and duct damage and repair as necessary.
6. Check system operating pressures via the UC8 (refer Section 5.2.5).
7. Remove lint and dust accumulation from outdoor coil fins with soft brush or low pressure water spray.
8. Touch up any paintwork damage to prevent corrosion.

---

## 8. TROUBLESHOOTING

### 8.1 Room temperature varies significantly from its setting

- Unit may have been incorrectly sized for the building.
- Drafts from wrongly placed supply air diffusers or from the back of the wall plaque could be affecting the temperature sensor built into the wall plaque.
- Poor air circulation in the room can cause incorrect temperature readings.

### 8.2 Air conditioner does not seem to deliver the heating when most needed

- Heating capacity at design conditions may be incorrect. As the outside temperature falls, heat losses through the walls, floor and ceiling increase.
- Check the unit's brochure for information on the minimum/maximum operating temperatures.

### 8.3 When heating, units have de-icing cycles built in to remove ice on the outdoor coil.

- This usually means reversing the cycle for a few minutes during which time there is no heating and in fact a little cooling can occur.

### 8.4 In a new building, why does it take some days before the air conditioning heat hump unit seems to work properly

- Many new buildings, especially a commercial buildings, have a large amount of concrete and other structural materials that are generally cold and full of moisture. This is most evident in the winter when trying to heat the building from ambient conditions.

### 8.5 Unit is leaking water

- Check the drain trap/vent/slope.
- Water carry-over: Reduce the maximum fan speed.

### 8.6 Air conditioner runs excessively – the temperature remains too hot in summer or too cold in winter.

- Windows or doors may be opened to non conditioned areas.
- Keep doors to unconditioned areas closed.
- Leaves, papers or other items blocking air flow over the outdoor unit coil.
- Location of wall controller or remote temperature sensor is incorrect.
- Check for leaks in supply or return air ductwork.

### 8.7 Real Time Clock loses it's time when power is removed

A small lithium battery maintains the real time clock during power outages and requires replacing once every 3 to 5 years. (Part number CR1220 or equivalent). This is on the main Viking printed circuit board and requires the removal of the plastic enclosure to replace.

### 8.9 Outdoor unit displays an error code:

- Refer to UC8 Controller label on the unit for operation & fault diagnostics information or visit [www.temperzone.biz](http://www.temperzone.biz); model search 'UC8'.

**Further Fault diagnostic information can be found in the Viking User & Installer manual.**

---

## 9. WARRANTY

Please refer to the separate warranty document supplied with the unit, or visit [www.temperzone.biz](http://www.temperzone.biz) for details.

Australia:

[warranty@temperzone.com.au](mailto:warranty@temperzone.com.au)

[spares@temperzone.com.au](mailto:spares@temperzone.com.au)

Telephone: 1800 21 1800













New Zealand:

[customerservices@temperzone.co.nz](mailto:customerservices@temperzone.co.nz)

Telephone: 0800 TZWARRANTY (899 2777)

## 10. UC8 CONTROLLER DISPLAY

**Table 1**, Information available on the UC8 display.

Item	Unit	Abbreviation	Examples
Compressor suction line pressure	kPa	SLP	 Suction line pressure 1034 kPa
Evaporating temperature	°C	Et	 Evaporating temperature 12°C
Compressor suction line temperature	°C	SLt	 Suction line temperature 18°C
Compressor suction side superheat	K	SSH	 Suction side superheat 6K
Compressor discharge line pressure	kPa	dLP	 Discharge line pressure 2447 kPa
Condensing temperature	°C	Ct	 Condensing temperature 42 °C
Compressor discharge line temperature	°C	dLt	 Discharge line temperature 70°C
Compressor discharge side superheat	K	dSH	 Discharge side superheat 28K
De-ice sensor temperature (located on fins of the outdoor coil)	°C	ICEt	 De-ice sensor temperature 39°C
Capacity	%	CAP	 Capacity 100%
Expansion valve 1 opening	%	EE1	 Expansion valve 1 75% open
Expansion valve 2 opening	%	EE2	 Expansion valve 2 75% open

## 11. VIKING CONTROLLER : FACTORY SETTINGS

Installer to check settings for site suitability and adjust as necessary:

### SMT920 Controller

Function	Factory Settings (changes from defaults)
PIN number	21 (don't change)
Programming (Schedule)	Manual
Temp. Control Limits	Heat 26°C / Cool 17°C
Sensor Performance	Room '0.0VFAST SS'/ O/A '0.0 Nor'
Compressor Staging	1.0 / OFF / OFF /...
Room Sensor	Force Off
Auxiliary Input	Force On (Aux 1)
Economy Settings	Day Time Vent OFF
PI Setting	Y1: PI 25 10 / Y2: PI 25 05

### RS-SSD Wall Control

Function	Factory Setting
After Hours run period (Ah)	2
User On/Off (OO)	Off
User Modes (nn)	4 - Heat
Set Temp access (St)	2 - Heat & Cool
Heating Upper Limit. (HL)	26
Cooling Lower Limit (CL)	17
Sensor Speed	FSt
Display Only mode (dl)	Off
PIN (Pn)	21 (don't change)

Refer Wiring Diagram Sheet 2 for DIP switch settings



## APPENDIX I

### PROTECTION FUNCTIONS

The UC8 implements system protection functions such as indoor coil frost, extreme high and low pressures, rapid on-off cycling of the compressors, loss of refrigerant and more.

The following applies to all protection functions except where otherwise indicated:

Unit operating capacity may automatically be reduced before a protection function is activated. Such a reduction may be sufficient to prevent an actual trip from occurring.

When a compressor is stopped by a protection function it is held off for a period of 3 minutes, after which it is allowed to restart (provided the cause of the trip has cleared).

When a protection function is active and when a unit is locked out the alarm relay output "FLT" is active.

More detailed information about protection functions and troubleshooting refer to document "UC8 troubleshooting information", available for free download from the temperzone internet website.

#### 1 High pressure protection (HP)

OPA Econex units are fitted with high pressure transducers connected to UC8 input HPT. A compressor is switched off when the discharge line pressure reading exceeds 4151 kPa.

The display shows the letters 'HP' when protection is active. 

#### 2 Low pressure protection (LP)

OPA Econex units are fitted with low pressure transducers connected to UC8 input LPT. A compressor is switched off when the suction line pressure reading falls below 228 kPa.

The display shows the letters 'LP' when protection is active. 

#### 3 Indoor coil frost protection

When the unit is cooling the evaporating temperature in the indoor coil should remain above -8°C. If this temperature falls below -8°C then ice (frost) likely will form on the indoor coil. If the low temperature persists for longer than 6 minutes then the protection function activates.

When indoor coil frost protection is activated the compressor is stopped for 6 minutes, after which it is allowed to restart. 

#### 4 High discharge line temperature protection

The controller monitors the compressor discharge line temperature via a sensor connected to input 'DL' (red wires). The compressor is stopped when:

- The temperature rises above 115°C for longer than 15 minutes.
- The temperature rises above 125°C for longer than 2 minutes.

The display shows the message 'Hi-t' when protection is active. 

#### 5 High discharge superheat protection

Discharge superheat is defined as the difference between the compressor discharge gas temperature and the condensing temperature. When this temperature differential becomes very high it is an indication that the compressor is being starved of refrigerant gas. Common reasons for this could be a lack of refrigerant (under-charged or loss-of-charge) or a problem with the expansion device (for example a stuck accumulator or loose wiring to an EEV).

The protection is activated when discharge superheat exceeds 60K for longer than 30 minutes.

The display shows the message 'Hi-dSH' when protection is active. 

#### 6 Low discharge superheat protection

Discharge superheat is defined as the difference between the compressor discharge gas temperature and the condensing temperature. When this temperature differential stays very low it can be an indication that the compressor is being flooded with liquid refrigerant. Common reasons for this could be an excess of refrigerant (over-charged) or a problem with the expansion device (for example a stuck accumulator or loose wiring to an EEV).

The protection is activated when discharge superheat remains below the threshold for longer than 15 minutes. The threshold varies linearly from 0K at standard mode minimum capacity (40%) to 10K at nominal capacity (100%).

This protection function is disabled when a compressor operates at less than standard mode minimum capacity (< 40%).

The threshold for a variable speed compressor operated in boost mode (capacity above 100%) is fixed at 10K.

The display shows the message 'LO-dSH' when protection is active. 

#### 7 High evaporation temperature / high suction line temperature protection

When the unit has a low pressure transducer connected to the compressor suction line then the controller calculates the evaporating temperature from the suction line pressure reading. If the unit does not have a low pressure transducer then the controller finds the evaporating temperature via a coil temperature sensor (input IC when the unit is cooling, input OC when the unit is heating, blue wires). Additionally the controller monitors the compressor suction line temperature via a sensor connected to input 'SL' (white wires).

The protection function stops the compressor when:

- The evaporating temperature remains above 27.5°C for longer than 15 minutes.
- The suction line temperature remains above 30°C for longer than 15 minutes.

The display shows the message 'Hi-SL' when protection is active. 

#### 8 Other alarms

The controller performs many other protection functions. For example:

- Signals from sensors and transducers must remain inside normal operating range.
- Modbus RTU communications with connected devices (e.g. RS-SSD wall control, a Carel Power+ inverter) must continue uninterrupted.
- Modbus RTU communications with a controller such as a BMS that is controlling the unit must continue uninterrupted.

Refer to document 'UC8 Troubleshooting Guide' for details.

## 9 Lock-out

Each protection function has a trip counter. A trip counter is reset to 0 whenever the compressor run request is removed. Any trip that has occurred more than 12 hours ago is removed from the trip count. For some protection functions, when the trip counter reaches value 3 (i.e. three consecutive trips occur) then the unit is "locked out".

When a unit is locked out the compressor is not allowed to start. Lock-out is designed to protect the compressor from repeatedly starting when a serious fault exists that requires the attention of a service technician.

The display shows the code of the fault that caused the lock-out condition.

A unit that is locked out can be unlocked using any one of the following methods:

- Remove mains power from the unit for at least 3 seconds, then restore power.
- Issue an 'unlock' command via Modbus RTU serial communications.
- Reset the controller via Modbus RTU serial communications.



## APPENDIX II

### AIR HANDLING PERFORMANCE

**Note:** Airflows are for a dry coil. Reduce airflow by 10% in wet coil conditions. In a free blow or low resistance application, beware of exceeding indoor fan motor's full load amp limit (refer Specifications document).

As filters are optional, the fan air flows given are for units installed without filters.

#### OPA 250RLTFP

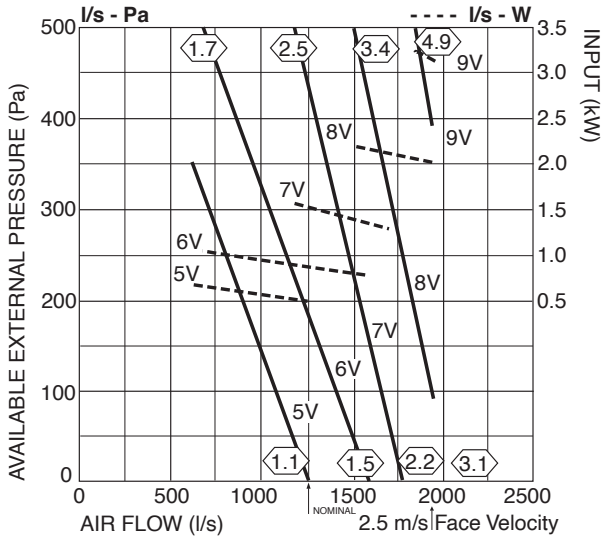

#### OPA 350RLTFP

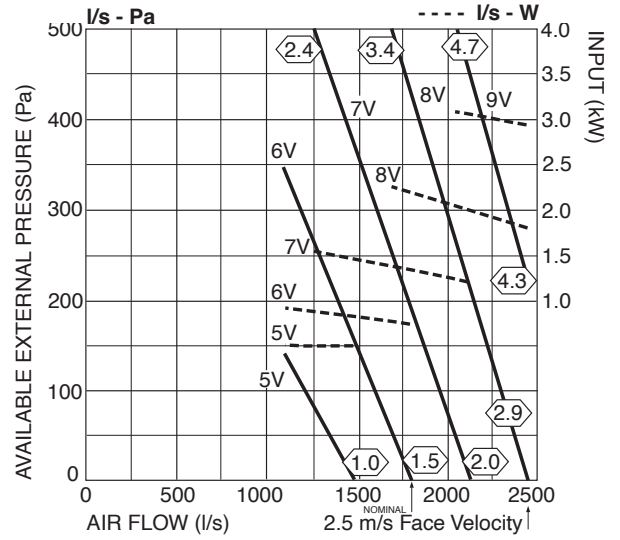

#### OPA 450RLTFP

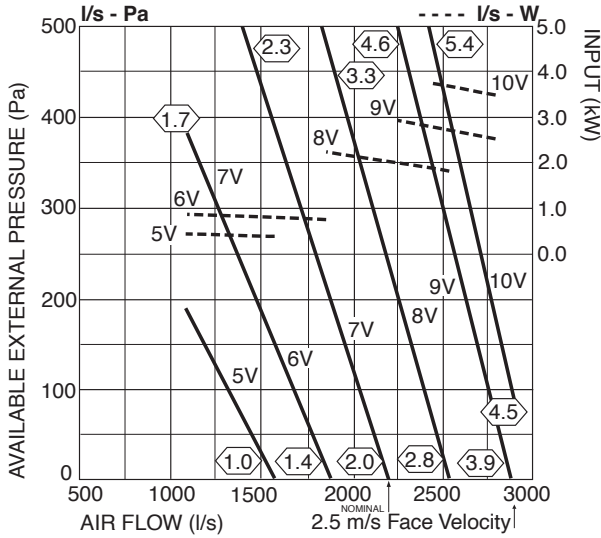

#### OPA 560RLTFP

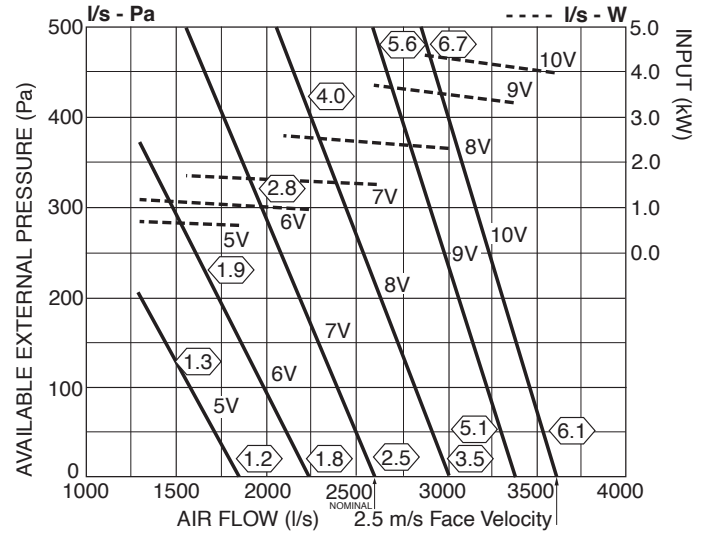

## COMMISSIONING CHECK LIST

Site Name/address: .....

Installing Company ..... Date: .....

Serviceman: ..... Tel: .....

Model ..... Serial No..... Site Ref. ....

Unit mounted level?	Y / N	Supply voltage checked?	Y / N
Temperzone recommended drain trap fitted?	Y / N	External electrical isolator fitted?	Y / N
Water drains tested okay? (panels on, fan running)	Y / N	Indoor Plug fan set voltage	V
Does unit have adequate safe access?	Y / N	Are temperature controller's parameters set?	Y / N
All electrical terminals are tight?	Y / N	Checked for excessive noise & vibration of unit?	Y / N
Return air filters fitted?	Y / N	Has client had controls demo?	Y / N
Removed compressor shipping blocks?	Y / N	Electrical Certificate Of Compliance issued?	Y / N
Refrigeration leak checked?	Y / N	Fresh air damper setting (if applicable)	I/s
Is air flow set and balanced?	Y / N		
Alternative control type:	BMS / Other? (name):		

**Mark UC8 dip switch positions with an 'X'**

	SW1							
	1	2	3	4	5	6	7	8
On								
Off								

	SW2							
	9 (1)	10 (2)	11 (3)	12 (4)	13 (5)	14 (6)	15 (7)	16 (8)
On								
Off								

**Record the following UC8 monitored conditions using push button SW3 (repeat to scroll through list).**

**IMPORTANT:** Digital compressors must be operating at 100% for at least 10 minutes when taking these readings.

			System 1
<b>Cool Cycle:</b>	Low Pressure:	SLP	kPa
	Evap temperature:	Et	°C
	Suction Line temperature:	SLt	°C
	Suction Superheat:	SSH	K
	Discharge Line Pressure:	dLP	kPa
	Condensing temperature:	Ct	°C
	Discharge Line temperature:	dLt	°C
	Discharge Superheat:	dSH	K
	De-ice Sensor temperature:	ICEt	°C
	Required Capacity:	CAP	%
	Expansion Valve 1:	EE1	%
	Expansion Valve 2:	EE2	%

Outdoor Ambient temperature:	°C
Indoor Return air temperature:	°C
Indoor Supply air temperature:	°C
Indoor fan amps :	A
Fresh Air introduced :	%
Compressor current :	A

<b>Heat Cycle:</b>	Low Pressure:	SLP	kPa
	Evaporating temperature:	Et	°C
	Suction Line temperature:	SLt	°C
	Suction Superheat:	SSH	K
	Discharge Line Pressure:	dLP	kPa
	Condensing temperature:	Ct	°C
	Discharge Line temperature:	dLt	°C
	Discharge Superheat:	dSH	K
	De-ice Sensor temperature:	ICEt	°C
	Required Capacity:	CAP	%
	Expansion Valve 1:	EE1	%
	Expansion Valve 2:	EE2	%

Outdoor Ambient temperature:	°C
Indoor Return air temperature:	°C
Indoor Supply air temperature:	°C
Indoor fan amps :	A
Fresh Air introduced :	%
Compressor current :	A

NOTE: This document to be kept with the unit. Failure to provide this completed page on request by Temperzone may affect unit warranty.